



© Agilent Technologies, Inc. 2000-2011

5301 Stevens Creek Blvd., Santa Clara, CA 95052 USA

No part of this documentation may be reproduced in any form or by any means (including electronic storage and retrieval or translation into a foreign language) without prior agreement and written consent from Agilent Technologies, Inc. as governed by United States and international copyright laws.

**Acknowledgments**

Mentor Graphics is a trademark of Mentor Graphics Corporation in the U.S. and other countries. Mentor products and processes are registered trademarks of Mentor Graphics Corporation. \* Calibre is a trademark of Mentor Graphics Corporation in the US and other countries. "Microsoft®, Windows®, MS Windows®, Windows NT®, Windows 2000® and Windows Internet Explorer® are U.S. registered trademarks of Microsoft Corporation. Pentium® is a U.S. registered trademark of Intel Corporation. PostScript® and Acrobat® are trademarks of Adobe Systems Incorporated. UNIX® is a registered trademark of the Open Group. Oracle and Java and registered trademarks of Oracle and/or its affiliates. Other names may be trademarks of their respective owners. SystemC® is a registered trademark of Open SystemC Initiative, Inc. in the United States and other countries and is used with permission. MATLAB® is a U.S. registered trademark of The Math Works, Inc.. HiSIM2 source code, and all copyrights, trade secrets or other intellectual property rights in and to the source code in its entirety, is owned by Hiroshima University and STARC. FLEXIm is a trademark of Globetrotter Software, Incorporated. Layout Boolean Engine by Klaas Holwerda, v1.7 <http://www.xs4all.nl/~kholwerd/bool.html> . FreeType Project, Copyright (c) 1996-1999 by David Turner, Robert Wilhelm, and Werner Lemberg. QuestAgent search engine (c) 2000-2002, JObjects. Motif is a trademark of the Open Software Foundation. Netscape is a trademark of Netscape Communications Corporation. Netscape Portable Runtime (NSPR), Copyright (c) 1998-2003 The Mozilla Organization. A copy of the Mozilla Public License is at <http://www.mozilla.org/MPL/> . FFTW, The Fastest Fourier Transform in the West, Copyright (c) 1997-1999 Massachusetts Institute of Technology. All rights reserved.

The following third-party libraries are used by the NlogN Momentum solver:

"This program includes Metis 4.0, Copyright © 1998, Regents of the University of Minnesota", <http://www.cs.umn.edu/~metis> , METIS was written by George Karypis (karypis@cs.umn.edu).

Intel® Math Kernel Library, <http://www.intel.com/software/products/mkl>

SuperLU\_MT version 2.0 - Copyright © 2003, The Regents of the University of California, through Lawrence Berkeley National Laboratory (subject to receipt of any required approvals from U.S. Dept. of Energy). All rights reserved. SuperLU Disclaimer: THIS SOFTWARE IS PROVIDED BY THE COPYRIGHT HOLDERS AND CONTRIBUTORS "AS IS" AND ANY EXPRESS OR IMPLIED WARRANTIES, INCLUDING, BUT NOT LIMITED TO, THE IMPLIED WARRANTIES OF MERCHANTABILITY AND FITNESS FOR A PARTICULAR PURPOSE ARE DISCLAIMED. IN NO EVENT SHALL THE COPYRIGHT OWNER OR CONTRIBUTORS BE LIABLE FOR ANY DIRECT, INDIRECT, INCIDENTAL, SPECIAL, EXEMPLARY, OR CONSEQUENTIAL DAMAGES (INCLUDING, BUT NOT LIMITED TO, PROCUREMENT OF SUBSTITUTE GOODS OR SERVICES; LOSS OF USE, DATA, OR PROFITS; OR BUSINESS INTERRUPTION) HOWEVER CAUSED AND ON ANY THEORY OF LIABILITY, WHETHER IN CONTRACT, STRICT LIABILITY, OR TORT (INCLUDING NEGLIGENCE OR OTHERWISE) ARISING IN ANY WAY OUT OF THE USE OF THIS SOFTWARE, EVEN IF ADVISED OF THE POSSIBILITY OF SUCH DAMAGE.

7-zip - 7-Zip Copyright: Copyright (C) 1999-2009 Igor Pavlov. Licenses for files are: 7z.dll: GNU LGPL + unRAR restriction, All other files: GNU LGPL. 7-zip License: This library is free software; you can redistribute it and/or modify it under the terms of the GNU Lesser General Public License as published by the Free Software Foundation; either version 2.1 of the License, or (at your option) any later version. This library is distributed in the hope that it will be useful, but WITHOUT ANY WARRANTY; without even the implied warranty of MERCHANTABILITY or FITNESS FOR A PARTICULAR PURPOSE. See the GNU Lesser General Public License for more details. You should have received a copy of the GNU Lesser General Public License along with this library; if not, write to the Free Software

Foundation, Inc., 59 Temple Place, Suite 330, Boston, MA 02111-1307 USA. unRAR copyright: The decompression engine for RAR archives was developed using source code of unRAR program. All copyrights to original unRAR code are owned by Alexander Roshal. unRAR License: The unRAR sources cannot be used to re-create the RAR compression algorithm, which is proprietary. Distribution of modified unRAR sources in separate form or as a part of other software is permitted, provided that it is clearly stated in the documentation and source comments that the code may not be used to develop a RAR (WinRAR) compatible archiver. 7-zip Availability: <http://www.7-zip.org/>

AMD Version 2.2 - AMD Notice: The AMD code was modified. Used by permission. AMD copyright: AMD Version 2.2, Copyright © 2007 by Timothy A. Davis, Patrick R. Amestoy, and Iain S. Duff. All Rights Reserved. AMD License: Your use or distribution of AMD or any modified version of AMD implies that you agree to this License. This library is free software; you can redistribute it and/or modify it under the terms of the GNU Lesser General Public License as published by the Free Software Foundation; either version 2.1 of the License, or (at your option) any later version. This library is distributed in the hope that it will be useful, but WITHOUT ANY WARRANTY; without even the implied warranty of MERCHANTABILITY or FITNESS FOR A PARTICULAR PURPOSE. See the GNU Lesser General Public License for more details. You should have received a copy of the GNU Lesser General Public License along with this library; if not, write to the Free Software Foundation, Inc., 51 Franklin St, Fifth Floor, Boston, MA 02110-1301 USA Permission is hereby granted to use or copy this program under the terms of the GNU LGPL, provided that the Copyright, this License, and the Availability of the original version is retained on all copies. User documentation of any code that uses this code or any modified version of this code must cite the Copyright, this License, the Availability note, and "Used by permission." Permission to modify the code and to distribute modified code is granted, provided the Copyright, this License, and the Availability note are retained, and a notice that the code was modified is included. AMD Availability: <http://www.cise.ufl.edu/research/sparse/amd>

UMFPACK 5.0.2 - UMFPACK Notice: The UMFPACK code was modified. Used by permission. UMFPACK Copyright: UMFPACK Copyright © 1995-2006 by Timothy A. Davis. All Rights Reserved. UMFPACK License: Your use or distribution of UMFPACK or any modified version of UMFPACK implies that you agree to this License. This library is free software; you can redistribute it and/or modify it under the terms of the GNU Lesser General Public License as published by the Free Software Foundation; either version 2.1 of the License, or (at your option) any later version. This library is distributed in the hope that it will be useful, but WITHOUT ANY WARRANTY; without even the implied warranty of MERCHANTABILITY or FITNESS FOR A PARTICULAR PURPOSE. See the GNU Lesser General Public License for more details. You should have received a copy of the GNU Lesser General Public License along with this library; if not, write to the Free Software Foundation, Inc., 51 Franklin St, Fifth Floor, Boston, MA 02110-1301 USA Permission is hereby granted to use or copy this program under the terms of the GNU LGPL, provided that the Copyright, this License, and the Availability of the original version is retained on all copies. User documentation of any code that uses this code or any modified version of this code must cite the Copyright, this License, the Availability note, and "Used by permission." Permission to modify the code and to distribute modified code is granted, provided the Copyright, this License, and the Availability note are retained, and a notice that the code was modified is included. UMFPACK Availability: <http://www.cise.ufl.edu/research/sparse/umfpack> UMFPACK (including versions 2.2.1 and earlier, in FORTRAN) is available at <http://www.cise.ufl.edu/research/sparse> . MA38 is available in the Harwell Subroutine Library. This version of UMFPACK includes a modified form of COLAMD Version 2.0, originally released on Jan. 31, 2000, also available at <http://www.cise.ufl.edu/research/sparse> . COLAMD V2.0 is also incorporated as a built-in function in MATLAB version 6.1, by The MathWorks, Inc. <http://www.mathworks.com> . COLAMD V1.0 appears as a column-preordering in SuperLU (SuperLU is available at <http://www.netlib.org> ). UMFPACK v4.0 is a built-in routine in MATLAB 6.5. UMFPACK v4.3 is a built-in routine in MATLAB 7.1.

Qt Version 4.6.3 - Qt Notice: The Qt code was modified. Used by permission. Qt copyright: Qt Version 4.6.3, Copyright (c) 2010 by Nokia Corporation. All Rights Reserved. Qt License: Your use or distribution of Qt or any modified version of Qt implies that you agree to this License. This library is free software; you can redistribute it and/or modify it under the terms of the GNU Lesser General Public License as published by the Free Software Foundation; either

version 2.1 of the License, or (at your option) any later version. This library is distributed in the hope that it will be useful, but WITHOUT ANY WARRANTY; without even the implied warranty of MERCHANTABILITY or FITNESS FOR A PARTICULAR PURPOSE. See the GNU Lesser General Public License for more details. You should have received a copy of the GNU Lesser General Public License along with this library; if not, write to the Free Software Foundation, Inc., 51 Franklin St, Fifth Floor, Boston, MA 02110-1301 USA Permission is hereby granted to use or copy this program under the terms of the GNU LGPL, provided that the Copyright, this License, and the Availability of the original version is retained on all copies.

User documentation of any code that uses this code or any modified version of this code must cite the Copyright, this License, the Availability note, and "Used by permission." Permission to modify the code and to distribute modified code is granted, provided the Copyright, this License, and the Availability note are retained, and a notice that the code was modified is included. Qt Availability:

<http://www.qtsoftware.com/downloads> Patches Applied to Qt can be found in the installation at: `$HPEESOF_DIR/prod/licenses/thirdparty/qt/patches`. You may also contact Brian Buchanan at Agilent Inc. at [brian\\_buchanan@agilent.com](mailto:brian_buchanan@agilent.com) for more information.

The HiSIM\_HV source code, and all copyrights, trade secrets or other intellectual property rights in and to the source code, is owned by Hiroshima University and/or STARC.

**Errata** The ADS product may contain references to "HP" or "HPEESOF" such as in file names and directory names. The business entity formerly known as "HP EEsof" is now part of Agilent Technologies and is known as "Agilent EEsof". To avoid broken functionality and to maintain backward compatibility for our customers, we did not change all the names and labels that contain "HP" or "HPEESOF" references.

**Warranty** The material contained in this document is provided "as is", and is subject to being changed, without notice, in future editions. Further, to the maximum extent permitted by applicable law, Agilent disclaims all warranties, either express or implied, with regard to this documentation and any information contained herein, including but not limited to the implied warranties of merchantability and fitness for a particular purpose. Agilent shall not be liable for errors or for incidental or consequential damages in connection with the furnishing, use, or performance of this document or of any information contained herein. Should Agilent and the user have a separate written agreement with warranty terms covering the material in this document that conflict with these terms, the warranty terms in the separate agreement shall control.

**Technology Licenses** The hardware and/or software described in this document are furnished under a license and may be used or copied only in accordance with the terms of such license. Portions of this product include the SystemC software licensed under Open Source terms, which are available for download at <http://systemc.org/>. This software is redistributed by Agilent. The Contributors of the SystemC software provide this software "as is" and offer no warranty of any kind, express or implied, including without limitation warranties or conditions or title and non-infringement, and implied warranties or conditions merchantability and fitness for a particular purpose. Contributors shall not be liable for any damages of any kind including without limitation direct, indirect, special, incidental and consequential damages, such as lost profits. Any provisions that differ from this disclaimer are offered by Agilent only.

**Restricted Rights Legend** U.S. Government Restricted Rights. Software and technical data rights granted to the federal government include only those rights customarily provided to end user customers. Agilent provides this customary commercial license in Software and technical data pursuant to FAR 12.211 (Technical Data) and 12.212 (Computer Software) and, for the Department of Defense, DFARS 252.227-7015 (Technical Data - Commercial Items) and DFARS 227.7202-3 (Rights in Commercial Computer Software or Computer Software Documentation).

Data Display Basics	7
Opening and Closing Data Display Windows	8
Inserting Pages	9
Creating a Data Display	10
Using a Dataset	11
Dataset Aliasing	13
Saving a Data Display	15
Exporting a Data Display Plot or List to an ASCII file	15
Exporting a Data Display List to a CSV file	15
Using a Template in Your Display	16
Viewing the Display Area	17
Editing a Data Display	19
Setting Data Display Preferences	22
Printing	22
Locating Data Display Examples	22
Customizing Keyboard Shortcuts	23
Configuring Toolbars	26
Data Display Templates	28
List of Templates	28
Plots and Lists	32
Inserting Plots	32
Editing Plots	34
Deleting Plots	38
Setting Plot Preferences	38
Antenna Plot	40
Inserting Lists	44
Editing Lists	46
Deleting Lists	47
Setting List Preferences	48
Using Legends	49
Traces	52
Inserting a Trace	52
Editing Traces	55
Deleting Traces	58
Setting Trace Preferences	58
History Traces	59
Memory Traces	60
Equations	62
Inserting Equations	62
Viewing Equation Results	64
Working with Multidimensional Data	65
Working with Swept S-parameters	71
Viewing Variable Information	76
Using Markers in Equations	77
Generating a Histogram after Monte-Carlo Analysis	78
Using Predefined Equations	79
Sliders	81
Inserting Slider	81
Annotating the Data Display	84
Inserting Text	84
Editing Text	86
Deleting Text	87
Setting Text Preferences	87
Inserting Objects	88
Editing Objects	88
Deleting Objects	89
Setting Object Preferences	89

Setting Grid/Snap Preferences	91
Adding Date and Time to a Data Display	93
Markers	94
Inserting Markers	94
Moving Markers	95
Editing Markers	95
Changing Marker Type	99
Deleting Markers	99
Setting Marker Preferences	99
Marker Readout	102
Delta Mode	103
Offset Marker	104
Peak and Valley Markers	105
Line Marker	107
Max and Min Markers	110
Snapshot	111
Eye Diagram FrontPanel	112
Defining Data Rate	112
Changing Measurement Settings	113
Making Measurements	113
Saving the FrontPanel	122
Jitter Analysis FrontPanel	123
Measurement Setup Dialog	124
Performing the Jitter Measurement Computation	128
Saving the FrontPanel	132
Load Pull Front Panel	133
Starting Loadpull FrontPanel	133
Reading 4.X Maury Data File with Frequency and Power Sweep	134
Plotting measured Data Points	134
Converting Maury 3.X Format to Maury 4.X Format	138
S-Parameter TDR FrontPanel	142
TDR FrontPanel Operations	143
S-Parameter TDR FrontPanel Utilities	144
TDR FrontPanel Functionality	147
Other Operations	158
Exported List Data (CSV Format)	165
About the Format	165
CSV Data Export Process	165
Simple Data Export Example	166
Matrix Data Export Example	167
Swept Data Export Example	168
Swept Matrix Data Export Example	169
Running the Data Display as a Stand-Alone Program	172
The dds Command	172
File Paths in the dds Command	172
Using the -dataset Option	173
Using the -cmd Option	173
Using the <dataDisplayFile> Argument	174

# Data Display Basics

Data generated by a simulation, as well as data that has been imported from other sources, such as a network analyzer or CITIfile, is stored in a *dataset*. The Data Display window enables you to view and analyze a dataset.

In a Data Display window you can:

- Display data in a variety of plots and formats
- Create plots with more than two axes.
- Add markers to traces to read specific data points
- Write mathematical equations to perform complex operations on data, and display the results
- Add text and drawing objects to enhance your documentation
- Edit plot titles and axis labels, equations, text, drawing objects, and column headings in lists.

Data can be plotted on rectangular plots, polar plots, Smith charts, and stacked plots. Data can be displayed as linear traces, histograms, scatter plots, and spectral plots, as well as in digital and wide-word (bus) data formats. In addition to graphical displays of data, data can be viewed numerically in lists.

The basic process of creating a data display consists of the following steps.



The various plot and trace types enable you to display data in different formats. In addition, you can use equations to perform complex mathematical operations on data for further analysis.

## Spurious-Free Dynamic Range Calculation

The spurious-free dynamic range is calculated here as the difference in power between a desired IF signal at the output and the noise floor, when the intermodulation distortion power is equal to the noise floor power. In this case the IM terms are below the noise floor, so the input power to the mixer must be increased until the IM terms reach the noise floor. Delta is the difference between the noise floor and the IM terms, and the IF signal power must increase by 1/3 of this difference for the IM and noise floor terms to be equal.

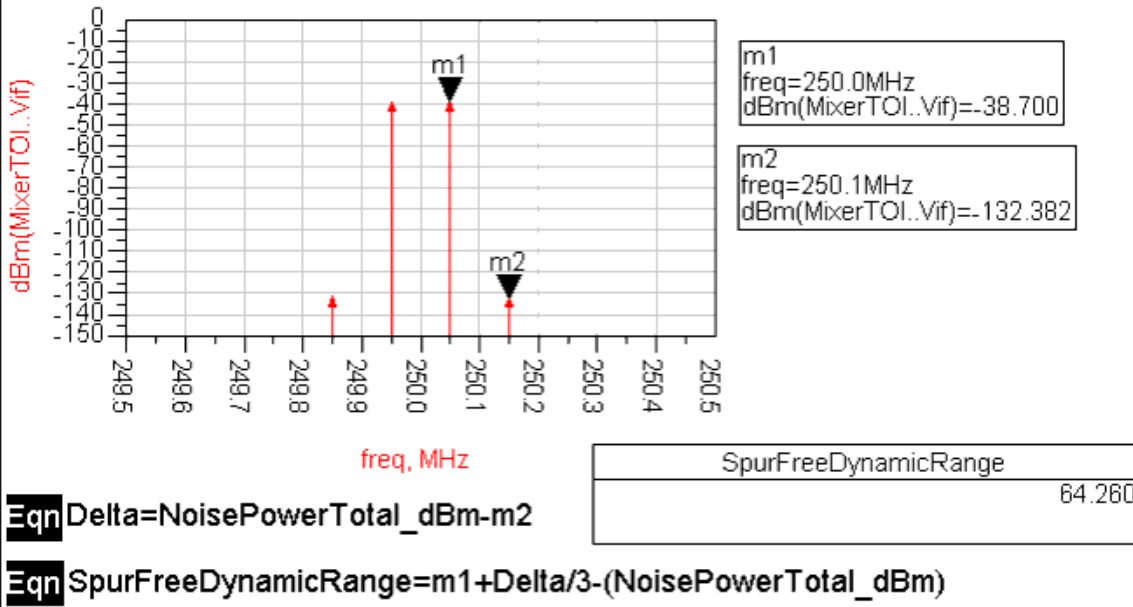

## Opening and Closing Data Display Windows

You can open a new Data Display window by following any of the following methods:

- From ADS main window, choose **Window > New Data Display** to open the new Data Display window.
- From the ADS main window, click the **New Data Display Window** icon  in toolbar.
- From the Schematic window, click the **New Data Display Window** icon .

To open additional windows from a Data Display window:

- Choose **Window > New** to open a new window showing the same contents as the current window.
- Choose **File > New** (or click the **Open A New Data Display Window** icon) to open a new empty window.

To open an existing data display file:

- Choose **Window > Open Data Display** from the ADS Main or Schematic window, select the data



display file (.dds), and click **Open**.

- From the Data Display window and choose **File > Open**. Select the data display file (.dds) and click **Open**.

To close a data display window:

- Choose **Window > Close** in the window you want to close. This closes only the active window and does not affect the rest of the data display. If the contents of the display have been modified and it is the only window displaying data from that data display file, you will be prompted to save.
- Choose **File > Close** to close all windows that are showing the current data display file (if the contents have been modified, you will be prompted to save). When the data display file is opened again, the same number of windows will be opened to display it.

The basic elements of a data display window are:

- The *Menu bar* displays the menus that are available in a Data Display window.
- The *Dataset List* displays the datasets available in a Data Display window.
- The *Title bar* displays the window type, filename, and a number for identifying which data display window it is.
- The *Toolbar* contains buttons for frequently used commands.
- The *Display Area* is where you create your data presentations.
- The *Data File Tool* enables you to transfer data between datasets and files that are in the following file formats:
  - Touchstone
  - Measurement data interchange format (MDIF)
  - CITIfile
  - IC-CAP

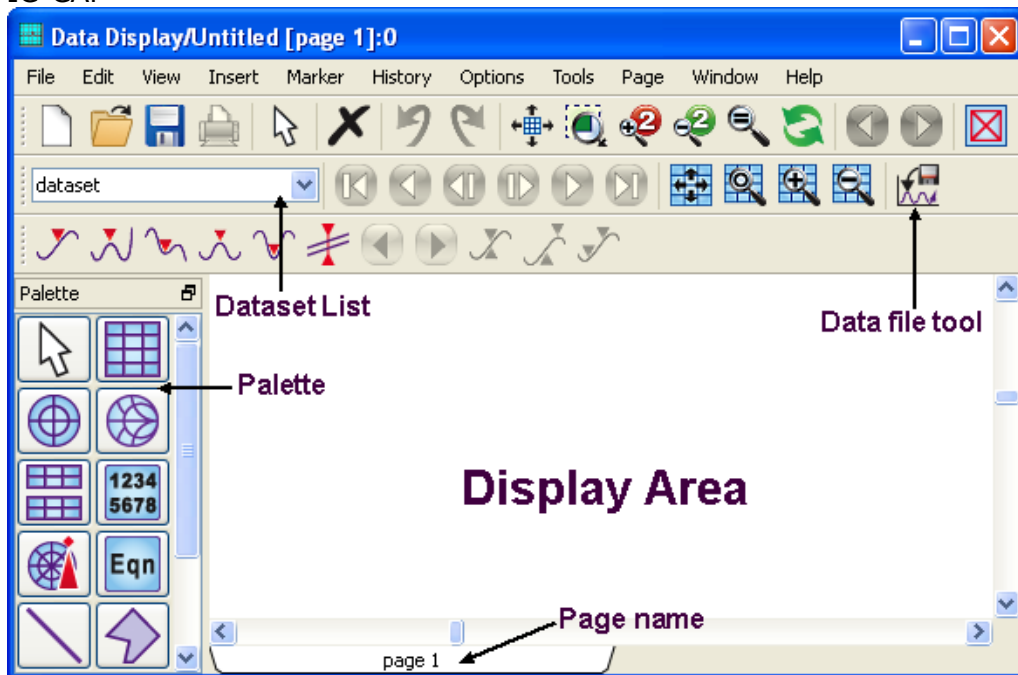

## Inserting Pages

The Data Display enables you to add multiple pages to the display area. Multiple pages provide you with additional display area that can be used to display and organize large amounts of data. To insert a new page:

1. Choose **Page > New Page**. The New Page dialog box appears.
2. Enter a new name for the page.
3. Click the **OK** button to close the dialog box and insert the page.

## Viewing Multiple Pages

When you have more than one data display page, the quickest way to select a page for viewing is to click on one of the tabs at the bottom of the Data Display window. (The tab name for the currently selected page is highlighted with a white background.) You can also select a page by name from the list at the bottom of the **Page** menu, or select **Page > Next Page** or **Page > Previous Page**.

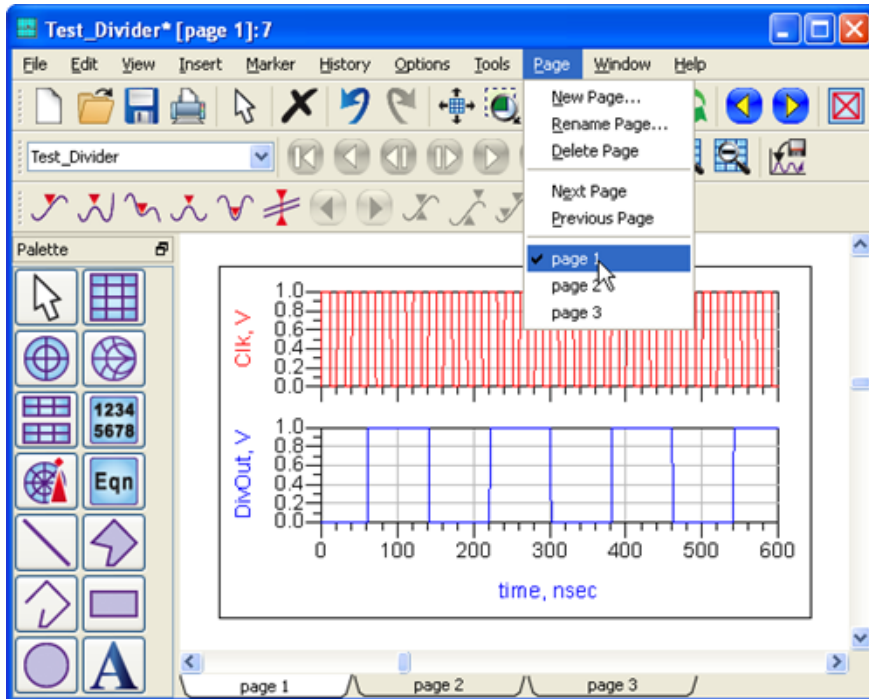

You can also step through the sequence of pages using the *View Previous Page* and *View Next Page* buttons on the toolbar as illustrated below:



**Note**  
If there is only one page, the menu items and page buttons described above are not displayed; however, a tab for the existing page is always visible.

## Changing the Page Order

The left-to-right order of the pages, as represented by the tabs, is the same as the top-to-bottom order of the pages as listed in the **Page** menu. When a new page is added, a new tab appears (as the rightmost tab), and a new name is added to the menu list (at the bottom). However, the order of the pages can be changed if necessary.

To change the page order, simply click on a tab and drag it left or right to the desired position. The list shown in the **Page** menu will be updated automatically to show the new sequence.

## Creating a Data Display

The basic process of creating a data display consists of:

- Choosing a dataset (by name) to display
- Choosing a plot type for the display (Rectangular, Polar, etc.)
- Specifying the data variable to be displayed
- Choosing a trace type (Linear, Scatter, Histogram, etc.)

**Note**

The application uses the Auto trace type by default. In some cases, Auto will not provide accurate results and a trace type will need to be manually selected.

The various plot and trace types enable you to display data in different formats. Equations enable you to perform complex mathematical operations on data for further analysis.

Optionally, you can enhance your data display by adding:

- Markers identifying specific data points
- Text for clarification
- Graphical objects, such as lines and circles

## Using a Dataset

The numerical data presented in a data display window comes from two sources, datasets and equations. Datasets collect and store data either from internal sources, such as a simulation, or from external sources, such as a network analyzer or Touchstone file.

Using the data file tool, you can read a data file (i.e., Touchstone, MDIF, Citifile, or ICCAP) into a dataset, or you can write a data file from a dataset. To use the data file tool, choose the **Tools > Data File Tool** menu item. The dftool/mainWindow appears. Note that you may need to expand your window to view all available options.

For detailed information on using the data file tool, refer to *Reading and Writing Data Files* (cktsim) in *Using Circuit Simulators* (cktsim).

For information on how to write equations, refer to *Equations* (data).

## Choosing a Dataset

When you open a Data Display window, all datasets defined for the current workspace are available for display. One dataset is selected as the default; it will be used as the source of data unless a different dataset is chosen. If no datasets have been defined for the current workspace, the label on the drop-down menu displays the current design name.

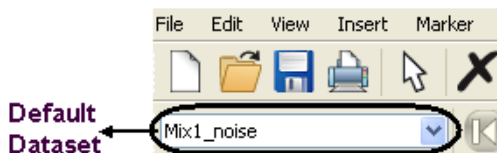

You can also view datasets that are stored under other workspaces or are not part of a workspace, such as a dataset that contains measured instrument data. This can be useful for comparing simulated versus actual results or comparing results between workspaces.

The data display does not store any data, it only retrieves and displays the data within a dataset.

Thus, if the data in the dataset changes (for example, if you alter a design and re-simulate), the data display will be updated to reflect the most current information in the dataset.

To choose a dataset:

1. Click the arrow to view the drop-down list of currently defined datasets.
2. Choose the name of the desired dataset. The Datasets and Equations list box is updated to reflect the data variables contained in the selected dataset.

## Adding a Dataset

To view a dataset outside of the current workspace:

1. Choose **Insert > Plot**.
2. Position the pointer, click, and select a plot type.
3. Click the **Manage** button in the Plot Traces & Attributes dialog box. The Dataset Alias Manager dialog box appears.
4. By default, datasets are saved with the *.ds* extension under the *<workspace\_name>/data* directory. Navigate to the file of interest and select the file. For more information, refer to [Dataset Aliasing](#).
5. Click **OK**.

## Using the Dataset Browser

The Dataset Browser enables you to clearly identify the hierarchy associated with a dataset variable name by displaying information in a tree structure. The browser also enables you to examine or select dataset variables from more than one dataset at a time.

The Dataset Browser is activated by selecting *Hierarchy* option from drop down list. This option is available from three different dialog boxes in the Data Display:

- Plot Traces & Attributes
- Enter Equation
- Browse Data

The functionality of this feature is the same regardless of how it is accessed.

### Example

To browse through the datasets and equations hierarchy using the dataset browser:

1. Choose **Insert > Plot**.
2. Position the pointer and click. The Plot Traces & Attributes dialog box appears.
3. Select a dataset from the Datasets and Equations drop-down menu.
4. Select a dataset variable from the list box and select the *Hierarchy* option from the drop down list. Note that the variable you selected in the flat view remains selected in the tree view. The dataset variables that are available in a dataset are displayed in the Datasets and Equations list box in a *tree structure*.



#### Note

In the tree view, when variables are selected and added to the trace list on the right, they are displayed in the trace list with the short unique name (same as in the flat view).

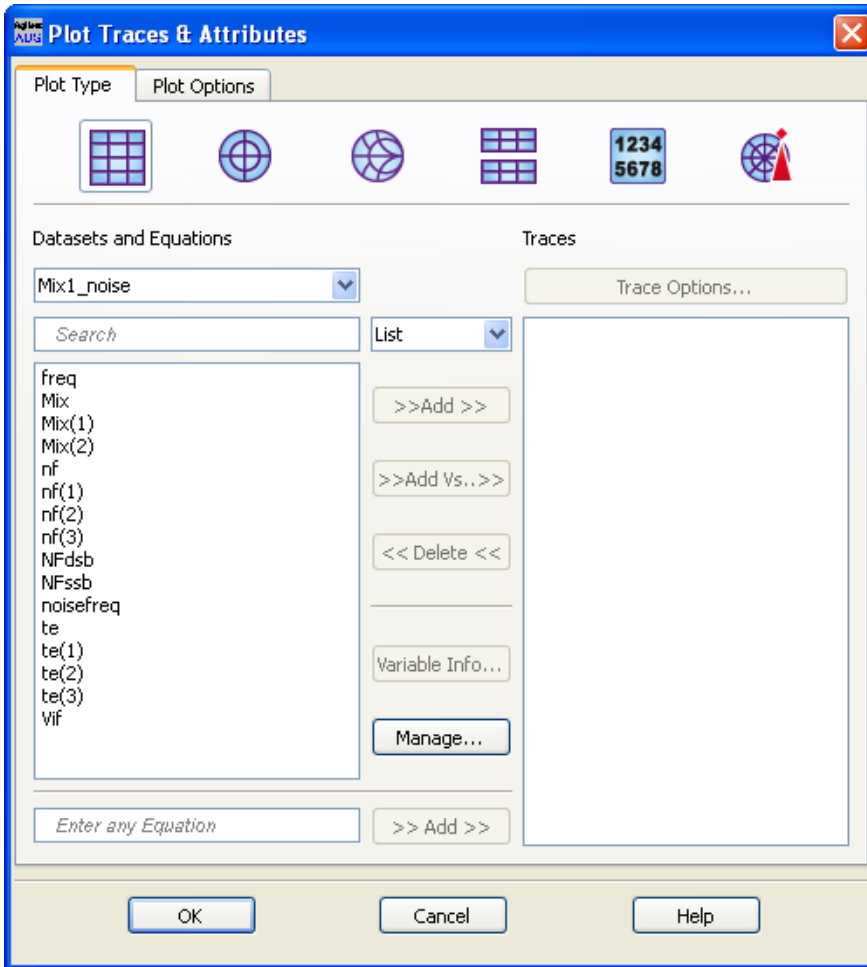

5. Use the **+** / **-** to further expand or collapse each item in the list. When a dataset is expanded, the hierarchy of the dataset variables within the dataset is displayed.

**Note**

Only the lowest level nodes can be selected in the dataset. More than one dataset variable may be selected in a dataset and the variables do not need to be included in the same dataset.

6. Select the *List* option to return to the default (flat) view. Only the shortest unique names are displayed in the flat view.

**Note**

When *Hierarchy* display is switched back to the flat view, the last item selected or expanded in the tree view is displayed in the flat view.

## Dataset Aliasing

The Dataset Alias Manager enables you to assign a shorter alias name to a dataset and use it within the Data Display in place of the longer dataset path name. Aliases and their associated datasets can be saved and made available between sessions.

## Using the Dataset Manager

Dataset alias names are managed using the *Dataset Alias Manager* in the Data Display. From within the Dataset Alias Manager you can:

- Add a new alias
- Edit an existing alias
- Remove an existing alias

To access the Dataset Alias Manager from a Data Display window:  
Choose **File > Manage Dataset Aliases** to start the Dataset Alias Manager dialog.

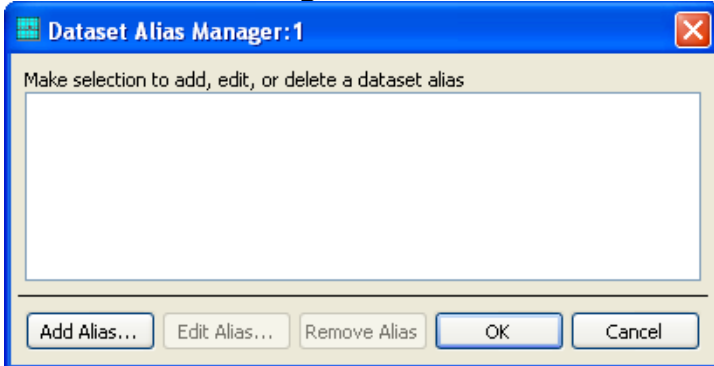

You can access the Dataset Alias Manager window from several other locations in the Data Display window such as:

- From the Plot Traces & Attributes dialog box, click the **Manage** button to start the Dataset Alias Manager dialog.
- From the Enter Equations dialog box, click the **Manage Datasets** button to start the Dataset Alias Manager dialog.

To add a new alias to the Dataset Alias Manager window:

1. Click the **Add Alias** button. The Add Dataset form appears.



2. Click the **Browse** button and use the dataset browser to locate a dataset. Click the **Add** button in the browser window to add the specified dataset to the Add Dataset form.
3. In the Add Dataset form, a unique alias name is supplied by default for newly selected datasets. You can choose your own unique alias and override the default name by simply typing over it in the *Alias* field.

**Note**

When choosing an alias name, try to select a unique name to avoid conflicts with existing aliases.

4. Click **OK** to add your new alias. Aliases are checked for unique names. If a conflict occurs, a message is displayed asking you to resolve the conflict. Choose a different alias name or remove the existing alias in conflict.
5. After you have added the new alias to the Dataset Manager window, click **OK** in the Dataset Manager window to save your changes.

To edit an existing alias from the Dataset Alias Manager window:

1. Select an alias in the Dataset Manager window and click the **Edit Alias** button. The *Edit Alias* form appears.
2. Modify the alias and/or dataset of the selected entry.
3. Click **OK** to implement your changes. The modified alias appears in the Dataset Manager.

To delete an existing alias from the Dataset Alias Manager window:

1. Select an alias in the Dataset Manager and click the **Remove Alias** button. A confirmation message appears asking if you are sure you want to remove the alias.
2. Click **OK** to confirm removing the alias or **Cancel** to abort the process.

## Saving a Data Display

There are three commands available for saving a data display: Save, Save As, and Save Copy As.

- Choose **File > Save** to save changes to the current data display window to an existing file. A file suffix of *.dds* is automatically appended to a data display file. Note that *.dds* files should be saved in the *<workspace\_name>* directory.
- Choose **File > Save As** to save the current data display window to a new file and change the currently open window view to the new file.
- Choose **File > Save Copy As** to save the current data display window to a new file and leave the currently open window view of the original file.

## Exporting a Data Display Plot or List to an ASCII file

Data displayed in rectangular plots, polar plots, Smith charts, stacked plots, and lists can be saved to a tab-delimited ASCII file.

To export a data display plot or list to a tab-delimited ASCII file:

1. Select one or more plots or lists.
2. Choose **File > Export > Write selected item to tab-delimited ASCII**. The *Write Data To ASCII File* window appears.
3. Enter a filename then click **OK**. A file suffix of *.txt* is automatically appended to the selected file name.

## Exporting a Data Display List to a CSV file

Data displayed in lists can be saved either as an ASCII file (as described above) or as a file in the CSV (Comma Separated Values) format. The CSV format is commonly used by spreadsheet applications and other tools (for more information on this format, see *Exported List Data (CSV Format) (data)*).

To export a data display list to a CSV file:

1. Select one or more lists.
2. Choose **File > Export > Write selected list to CSV file**, or else right-click on the selected lists and select **Export > CSV** from the pop-up menu. The *Open CSV Export File* window appears.
3. Enter a filename then click **OK**. A file suffix of *.csv* is automatically appended to the selected file name. An example of a CSV export is illustrated below; the list of S-parameters in the data display is reproduced fully in the exported CSV file, viewed here in Microsoft Excel.

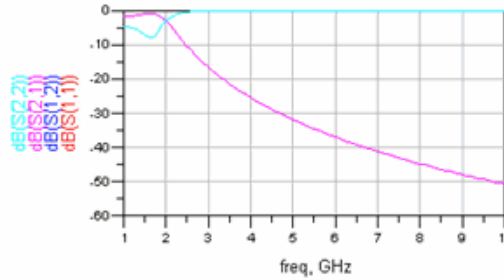

freq	S(1,1)	S(1,2)	S(2,1)	S(2,2)
1.000 GHz	0.574 / -147.983	0.819 / -70.928	0.819 / -70.928	0.574 / -173.874
1.100 GHz	0.571 / -151.200	0.821 / -77.058	0.821 / -77.058	0.571 / 177.083
1.200 GHz	0.557 / -153.871	0.831 / -83.585	0.831 / -83.585	0.557 / 166.700
1.300 GHz	0.531 / -155.703	0.848 / -90.767	0.848 / -90.767	0.531 / 154.169
1.400 GHz	0.493 / -156.027	0.870 / -98.914	0.870 / -98.914	0.493 / 138.200
1.500 GHz	0.447 / -153.467	0.894 / -108.370	0.894 / -108.370	0.447 / 116.726
1.600 GHz				
1.700 GHz				
1.800 GHz				
1.900 GHz				
2.000 GHz				
2.100 GHz				
2.200 GHz				
2.300 GHz				
2.400 GHz				
2.500 GHz				
2.600 GHz				
2.700 GHz				
2.800 GHz				
2.900 GHz				
3.000 GHz				
3.100 GHz				
3.200 GHz				
3.300 GHz				
3.400 GHz				
3.500 GHz				
3.600 GHz				
3.700 GHz				

	A	B	C	D	E	F
1	freq	S(1,1)	S(1,2)	S(2,1)	S(2,2)	
2	1.000 GHz	0.574 / -147.983	0.819 / -70.928	0.819 / -70.928	0.574 / -173.874	
3	1.100 GHz	0.571 / -151.200	0.821 / -77.058	0.821 / -77.058	0.571 / 177.083	
4	1.200 GHz	0.557 / -153.871	0.831 / -83.585	0.831 / -83.585	0.557 / 166.700	
5	1.300 GHz	0.531 / -155.703	0.848 / -90.767	0.848 / -90.767	0.531 / 154.169	
6	1.400 GHz	0.493 / -156.027	0.870 / -98.914	0.870 / -98.914	0.493 / 138.200	
7	1.500 GHz	0.447 / -153.467	0.894 / -108.370	0.894 / -108.370	0.447 / 116.726	
8	1.600 GHz	0.410 / -145.984	0.912 / -119.435	0.912 / -119.435	0.410 / 87.115	
9	1.700 GHz	0.413 / -133.788	0.911 / -132.160	0.911 / -132.160	0.413 / 49.467	

## Using a Template in Your Display

Templates are files that contain only the items that are placed in a display area. Templates enable you to store pre-configured plots and other graphical items, which you can use in any data display. For example, you may have a standard set of plots that you use in different workspaces. Rather than reinsert the plots and edit them for each data display, you design it once and save it as a template. You can then add these plots to any data display window by inserting the template.

Templates can include not only plots but traces, markers, annotation, or any other item that can be inserted in the display area. The only thing that is not saved in a data display template is the default dataset.

To save a data display as a template:

1. Choose **File > Save As Template** in the Data Display window. The Component Library/Save Template Browser appears.
2. In the Libraries list, select a directory in which to save the template.
  - **Product** - This selection contains templates that are shipped with the product. Templates in this section are located in *\$HPEESOF\_DIR/circuit/templates*
  - **User** - This selection provides a location for personal templates. Templates in this section are located in *\$HOME/hpeesof/circuit/templates*.
  - **Customized** - This selection is where site specific templates should be placed. This category may not appear in the browser if there are no templates stored in this location. Templates in this section are located in *\$HPEESOF\_DIR/custom/circuit/templates*.

**Note**

The **Product** and **Customized** directories are typically specified as read only so you may not have permissions to save to these directories.



3. Supply a name and click **OK**. The extension *.ddt* is automatically appended to filenames of data display templates.

To insert a data display template in an existing data display:

1. From the Data Display window, choose **Insert > Template**.
2. Navigate to the name of the template file that you want to use.
3. Click **OK**.

To insert a data display template in a new data display:

1. From a Data Display window, choose **File > New**.
2. Choose **Insert > Template**.
3. Navigate to the name of the template file that you want to use.
4. Click **OK**.

*Click here (data)* to see the Product (built-in) templates that are available to facilitate setting up common measurements.

## Viewing the Display Area

To aid in viewing your work, the following commands are available from the View menu and as buttons on the toolbar.

Command	Button	Description
View > View All	View All	View all graphical objects on the display area
View > Redraw View	Redraw View	Redraw the current view in the display area
View > Zoom > Zoom Area	Zoom Rectangle	Zoom in so the selected area fills the window
View > Zoom > Zoom In x2	Zoom x2	Zoom in to make objects appear twice as large
View > Zoom > Zoom Out x2	Zoom x1/2	Zoom out to make objects appear twice as small
View > Zoom > Actual Size	Actual Size	View objects at actual size

Like other windows in the product, the Data Display window has scroll bars along the window edges so you can pan across the display area.

## Scrolling Data in Lists and Plots

The Data Display toolbar includes (by default) a set of scroll buttons which enable you to scroll through long lists of data in list columns, or to scroll through data points in a rectangular plot (single or stacked). Because scrolling is slightly different in the case of a plot, separate procedures are given below.

### To scroll through list data:

1. Click on the list to select it.
2. If the scroll buttons are not currently visible in the toolbar, right-click on the list and select **Scroll Data...** from the popup menu; a small window containing the scroll buttons appears. (Alternatively, select **Scroll Data** from the **View** menu, and then select the displayed options for scrolling left and right.)
3. Use the scroll buttons as indicated in the figure below.

### Scrolling through list data

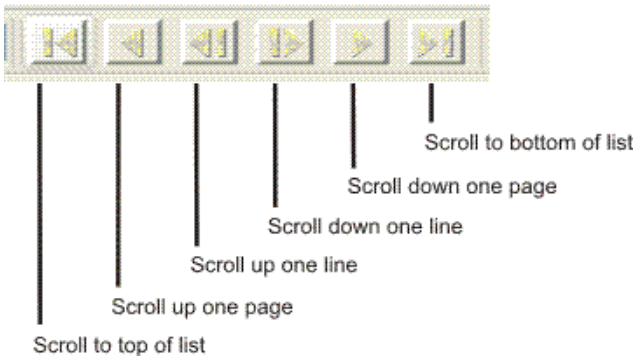

### To scroll through plot data:

**Note**  
 The scroll buttons are only functional in cases where data zooming has restricted the amount of data shown in the plot. If the data-zoom buttons in the toolbar ("Zoom In On Data By Specifying A Rectangle" and "Zoom In On Data") have been used to restrict the displayed data to a given range, the scroll buttons can be used to step through the rest of the data. If the "Autoscale Plot" button has been used to display all data, the scroll buttons will not be functional.

1. Click on the plot (not the trace) to select it.
2. If the scroll buttons are not currently visible in the toolbar, right-click on the plot and select **Scroll Data...** from the popup menu; a small window containing the scroll buttons appears. (Alternatively, select **Scroll Data** from the **View** menu, and then select the displayed options for scrolling left and right.)
3. Use the scroll buttons as indicated in the figure below.

### Zooming the plot data

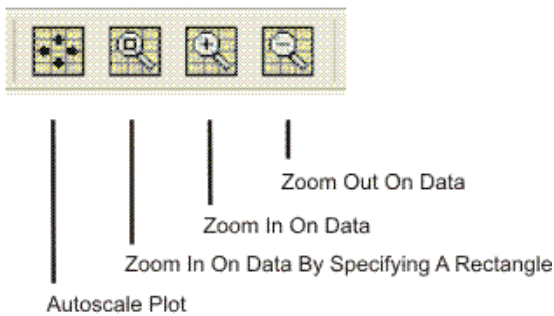

### Scrolling through plot data

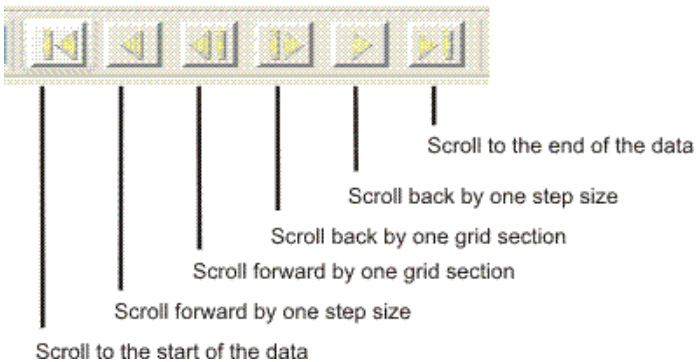

## Editing a Data Display

You can make changes to the data display as you work. The typical sequence is to select the object you wish to edit, then perform the operation. In some cases, you can select the command first and then the object. If an edit command has this capability, it is noted.

### Selecting Objects

You can select one, several, or all objects on a data display area to facilitate editing your work. A selected item is enclosed with a dashed outline and handles. A selected trace has a thicker, dashed appearance.

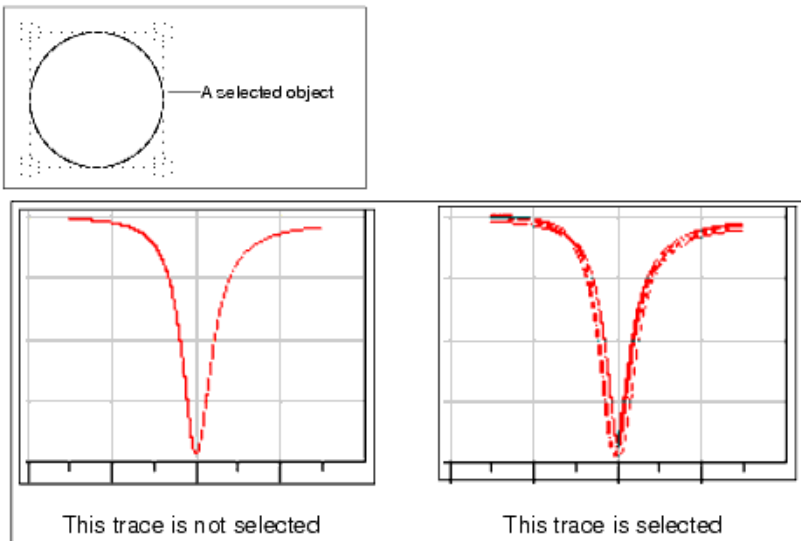

The following select options are available.

Option	Action
Select one object	Click the object.
Select several objects	Shift+click the objects.
Select all objects	Choose Edit > Select All.

### Deselecting an Object

If you want to deselect an object, click anywhere on the display area that is not occupied by the object.

### Moving Objects

You can move an object anywhere on the display area.

To move an object:

1. Select the object.
2. Drag the object to the new position.
3. The object remains selected and can be moved again.

To move several objects:

1. Select the objects.
2. Hold down the Shift key and drag the objects to the new position.

**Hint**  
 You can use the automatic panning feature by dragging an object to the edge of the data display window. While dragging an object, the window will automatically pan when the cursor is placed at the very edge (within a few pixels) of the display area. Note that you must be within the window, not the window border or scroll area.

## Snapping Objects to the Grid

A grid can be set up for the data display so that plots, lists, and other screen objects snap to the grid when they are moved or resized. This makes it easier to move the objects into exact alignment on the display, or to space them evenly.

In the illustration below, the grid has been set up to be visible, and to appear in the form of black dots (the grid can also be displayed as lines, or hidden entirely). The color and spacing of the displayed grid are configurable.

The snap origin for any object is located at the object's upper left corner (as indicated by the small green circles in the illustration below). When you move an object, it is the upper left corner which will snap to the nearest grid point. However, when you stretch an object by selecting it and dragging any of its corners, the edge that you are dragging will also snap to the grid.

Equations, notes, plots, lists, and other objects will snap to the grid when moved or resized. The location of the snap origin for each object is at the upper left corner (highlighted in this illustration by a small green circle).

Eqn PortZ10=PortZ(2)

freq	S(2,1)
1.000 GHz	0.819 / -70.928
1.500 GHz	0.894 / -108.3...
2.000 GHz	0.707 / -173.3...
2.500 GHz	0.304 / 146.808
3.000 GHz	0.148 / 130.787
3.500 GHz	0.084 / 122.402
4.000 GHz	0.053 / 117.132
4.500 GHz	0.036 / 113.454
5.000 GHz	0.025 / 110.714
5.500 GHz	0.019 / 108.579
6.000 GHz	0.014 / 106.863
6.500 GHz	0.011 / 105.449
7.000 GHz	0.009 / 104.261
7.500 GHz	0.007 / 103.248
8.000 GHz	0.006 / 102.373

## Scaling Objects

To scale an object:

1. Select the item.
2. Drag one of the object handles to reduce or enlarge the object to the desired size.

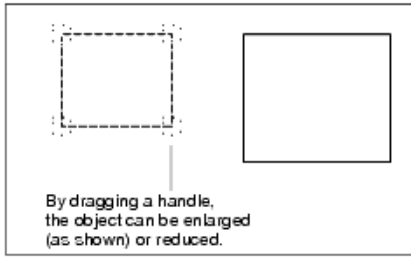

## Arranging Objects

Arranging objects is useful when you have overlapping objects. Select the object of interest and choose an arranging option. The following options are available.

Command	Description
Edit > Arrange > Move to Front	Displays the selected object in front of all other objects
Edit > Arrange > Send to Back	Displays the selected object behind all other objects
Edit > Arrange > Move Forward	Exchanges the positions of the selected object and the object in front of it
Edit > Arrange > Move Backward	Exchanges the positions of the selected object and the object behind it

## Activating or Deactivating Objects

If you want to selectively deactivate a plot or an equation in a data display:

1. Select the object or objects.
2. Click the *Toggle Activation of Object* button on the toolbar or choose **Edit > Toggle Activation**.



Once an object is deactivated, a red 'X' is drawn through the object to indicate that it has been deactivated. The object will not respond to any dataset updates while inactive. Equations are also removed from the variables list when inactive. This feature can be helpful in troubleshooting or when trying to speed up the re-draw process.

To activate a previously deactivated object:

1. Select the object or objects.
2. Click the *Toggle Activation of Object* button on the toolbar or choose **Edit > Toggle Activation**.

## Cutting, Copying, Pasting, and Deleting

You can perform cut, copy, paste, and delete operations in the Data Display much like other windows in the product. First select an item in the display area, then choose a command.

Command	Action	Keyboard Shortcut
Edit > Cut	Erase the selected object from the display area and place it on the clipboard	CTRL + X
Edit > Copy	Place a copy of the selected object on the clipboard	CTRL + C
Edit > Paste	Place the object on the clipboard in the display area	CTRL + V
Edit > Delete	Erase the selected object without placing it on the clipboard	DEL

## Setting Data Display Preferences

The appearance of each type of graphical object can be customized in a number of ways, depending on the type of object. Objects are drawn initially using program defaults, but you can change these characteristics and use them as new defaults for all workspaces, or you can save your settings to a file for use in an individual workspace.

To set new defaults for all workspaces:

1. Choose **Options > Preferences**.
2. Modify any or all settings as desired and click **Save**.
3. Save the modified settings in *\$HOME/hpeesof/config/ddsdefaults.ael*.
4. Click **OK**.

To save preferences for an individual workspace:

1. Choose **Options > Preferences**.
2. Modify any or all settings as desired and click **Save**.
3. Type the desired filename and click **OK**.

To read a preferences file:

1. Choose **Options > Preferences**.
2. Click **Read**. Navigate to the preferences file, then select the file. Objects will be drawn using the new preferences.
3. Click **OK**.

You can save different sets of preferences to different files. You can update a Data Display window at any time with a new preferences file. Reading in new preferences overwrites the existing ones.

For information on the characteristics you can change for the different types of objects, refer to the appropriate section.

Preferences to be Edited	Refer to
Plots and lists	<i>Plots and Lists (data)</i>
Traces	<i>Traces (data)</i>
Equations	<i>Equations (data)</i>
Lines, polylines, rectangles, circles, polygons	<i>Setting Object Preferences (data)</i>
Markers	<i>Markers (data)</i>
Text	<i>Setting Text Preferences (data)</i>
Grid/Snap	<i>Setting Grid/Snap Preferences (data)</i>

## Printing

The Data Display's print functions enable you to print the current page, selected item, or all pages. The print functions are available from the File menu. For information on setting up printers, refer to the ADS "*Schematic Capture and Layout*" documentation.

## Locating Data Display Examples

Many of the designs in the ADS *Examples* directory include data displays. The data displays use a variety of plots, trace formats, markers, and many include equations. These examples can help you design your own data displays so that you can analyze simulation data effectively. A list of some of the examples is given below.

Examples Subdirectory	workspace	Data Displays
Com_Sys	BER_wrk	Displays bit-error rate data in lists, as time-domain waveforms, and on scatter plots.
	cdmafilter_wrk	Displays the frequency response, unit step response, and unit pulse response of a filter.
	DeltaSigma_wrk	Displays the magnitude of the output of a delta-sigma modulator on a rectangular plot.
	gsm_wrk	Displays a variety of waveforms generated in a basic GSM 0.3 GSM system, including the output data, recovered clock, recovered carrier, modulated spectrum, and MSK trajectory.
	IS95_wrk	Displays the spectrum of a simple IS95 forward channel carrier on a rectangular plot.
	rfsystem_wrk	Displays a wide range of simulation results, including TOI in spectral format, budget data in lists, and channel spectra.
	widebandcdma_wrk	Displays waveforms generated in a wide CDMA modulator.
DSP	CHBT_TH_wrk	Displays a wide range of results simulating the output from a Sine wave.
Momentum	Balun_wrk	Compares S-parameters of a balun in magnitude and phase on rectangular plots.
	BoxExample_wrk	Compares the S-parameters from the box example to a set of reference S-parameters.
	Coupled_Stubs_wrk	Displays S-parameters in magnitude and phase on rectangular plots.
	CPW_line_wrk	Displays S-parameters in magnitude and phase on rectangular plots.
	Hairpin_filter_wrk	Displays the response of the filter.
	Low_pass_filter_wrk	Compares measured S(2,1) data to Momentum and Advanced Design simulations.
	Lp4_8Ghz_wrk	Identifies the numerical noise floor of the filter.
MW_Ckts	LNA_wrk	Displays a wide range of results from the simulations of a low-noise amplifier, including the S-parameters of an optimized amplifier displayed using lists, Smith charts, and rectangular plots; sweeps of collector-emitter voltage and collector current that display similar to a curve tracer; and the amplifier output from multiple input tones, displayed in spectral format.
	mw_filter_wrk	Displays the S-parameters of a 12 GHz bandpass filter, scaled for display on a rectangular plot.

## Customizing Keyboard Shortcuts

You can redefine default keyboard shortcuts as well as create new ones. These shortcuts are maintained individually for the different windows.

To change or add a keyboard shortcut:

1. Choose **Options > Hot Key/Toolbar Configuration** and click the **Hot Key** tab in the dialog box that appears.
2. Select the menu name or menu/command sequence from the Category list box.
3. Select the command from the Item list box. If a shortcut currently exists for the item, the current assignment is displayed.

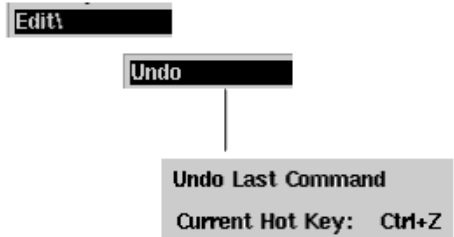

4. Select the modifier key(s)-Ctrl, Alt, Shift-and type the letter(s) you want to use in the Key field (UNIX is case-sensitive; the PC is not). If the combination you choose is currently assigned to another command sequence, you are warned and given the choice to proceed or to select another key sequence.

**Note**  
If you use *Alt* as the modifier key, and a letter that is already assigned as an accelerator for a menu (see the underscored letters on the menu bar), the menu accelerator is replaced by your custom shortcut (with no warning).

5. To replace the assignment with your own choice, continue, otherwise choose a new key combination and click **Apply**. When you are through making all keyboard changes, click **OK** to dismiss the dialog box.

## Shortcut Keys

[Shortcut Keys](#) lists the default keyboard shortcuts found in the Data Display windows. Some of the ADS individual tools also offer the ability to customize shortcut keys. For details on customizing these shortcuts, refer to the section, [Customizing Keyboard Shortcuts](#).

### Shortcut Keys



<b>File Commands</b>	
New	Ctrl + n
Open	Ctrl + o
Save	Ctrl + s
Print	Ctrl + p
<b>Edit Commands</b>	
End Command	Esc
Undo	Ctrl + z
Redo	Ctrl + y
Cut	Ctrl + x
Copy	Ctrl + c
Paste	Ctrl + v
Delete	Del
Select All	Ctrl + a
<b>View Commands</b>	
View All	Ctrl + f
<b>Window Commands</b>	
New	Ctrl + Shift + D
Close	Ctrl + F4
<b>Help Commands</b>	
What's This?	Shift + F1
Topics and Index	F1

[Sorted Default Shortcut Keys](#) lists the default shortcut keys, in alphabetical order, to enable you to see at a glance which ones are in use. If you attempt to assign any of these to other commands, you are warned and given the choice to proceed or to select another key sequence (see footnote for *Alt*).

**Sorted Default Shortcut Keys**

<b>Ctrl</b>	<b>Ctrl + Shift</b>	<b>Shift</b>	<b>Alt</b>	<b>Others</b>
Ctrl + a		Shift F1		Del
Ctrl + c				Esc
Ctrl + f				F1
Ctrl + f4				
Ctrl + n				
Ctrl + o				
Ctrl + p				
Ctrl + s				
Ctrl + v				
Ctrl + x				
Ctrl + y				
Ctrl + z				

**If you use *Alt* as the modifier key (when creating custom shortcuts), and a letter that is already assigned as an accelerator for a menu (listed in this table), the menu accelerator is replaced by your custom shortcut with no warning.**

## Configuring Toolbars

By default, the toolbar in each data display window contains:

- Buttons for Previous Page and Next Page.
- A button for activating or deactivating plots and equations.
- A drop-down list for selecting the default dataset.
- Buttons used to scroll through lists and traces.
- A button for autoscaling your plot.
- Buttons used to zoom in and out of data.
- A button used to start the Data File Tool.

You can reconfigure these default toolbars and create your own to better meet your design needs ( *Options > Hot Key/Toolbar Configuration* ).

### Customizing an Existing Toolbar

To reconfigure an existing toolbar:

1. Choose **Options > Hot Key/Toolbar Configuration** and click the **Toolbar** tab in the Configuration dialog box.
2. In the **Toolbar Group** list box, select the name of the toolbar you want to change.

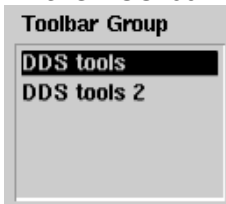

3. To add or delete icons, use one of the following methods:
  - To delete an icon from the toolbar, select the associated command in the Tool Item list box, and click the Cut button.

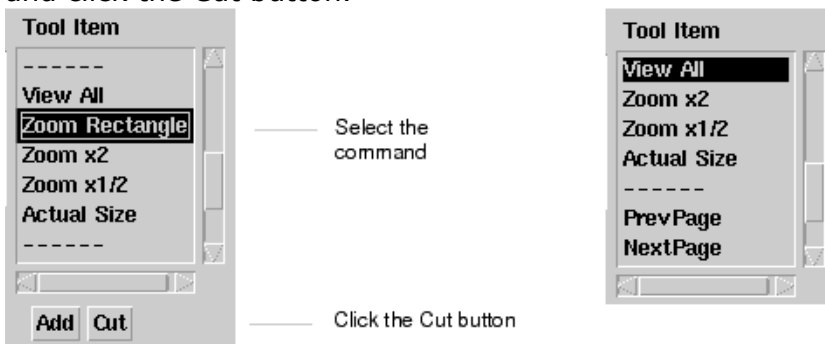

- To add an icon to the toolbar, select the appropriate menu/command sequence from the Menu Category list box, select the command from the Menu Item list box, and click the Add button. The command is added to the Tool Item list box.

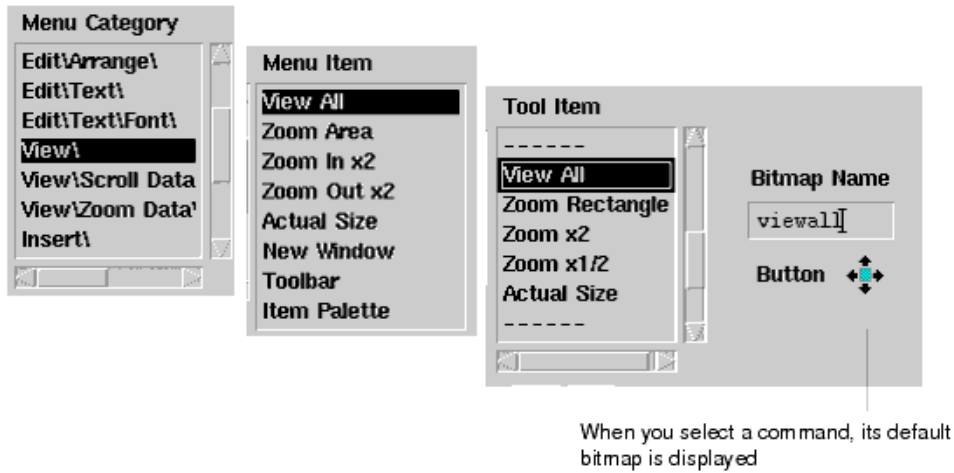

**Hint**  
 When you add a button to the toolbar, its position relative to the other buttons is determined by its position in the Tool Item list box. Before you click the **Add** button, be sure to highlight the command that the new command should precede. In this example, *Zoom Rectangle* was highlighted before the **Add** button was clicked so that *View All* would come before *Zoom Rectangle*.

- If you want to edit another toolbar, click **Apply** to effect these changes and begin the process again. When you are through making changes to the toolbars, click **OK**.

## Creating a New Toolbar

To create a custom toolbar:

- Choose **Options > Hot Key/Toolbar Configuration** and click the **Toolbar** tab in the Configuration dialog box that appears.

**Hint**  
 The position of the new toolbar, relative to the position of any existing toolbars, is determined by its position in the Toolbar Group list box; the new name is added *below* the name that is highlighted when you click the **Add** button. For example, if you keep both default toolbars and want to add a third one below them, highlight the bottom one before you click the **Add** button.

- Supply a name in the Toolbar Name field and click **Add**. The name entered is added to the Toolbar Group list box.
- Select the desired Menu Category, select the desired Menu Item and click the **Add** button above the Menu Item. The command name is added to the Tool Item list box.
- When you are through making changes to this toolbar, click **Apply** to effect the changes.
- When you are through making changes to all toolbars, click **OK**.

# Data Display Templates

Data Display Templates are files that contain only the items that are placed in a display area. These templates enable you to store pre-configured plots and other graphical items that can be used in any data display.

You can create your own templates or use default templates provided along with ADS release.

To create your own template you can save the file as template and then use the same in different workspaces. Templates can include plots, traces, markers, annotation, or any other item that can be inserted in the display area. The default dataset is not saved in a data display template.

To insert a data display template in an existing data display:

1. From the Data Display window, choose **Insert > Template**.

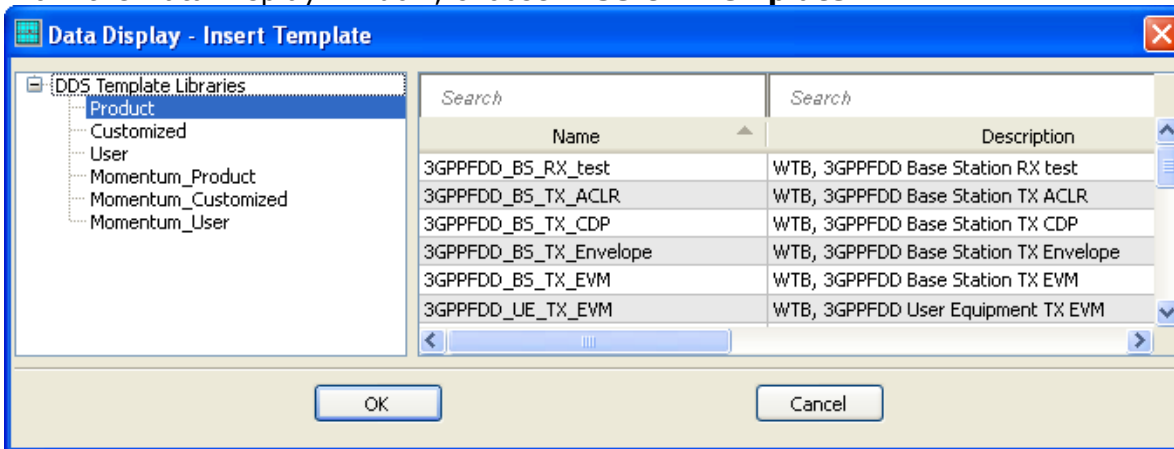

2. In Data Display Insert Template window, select the name of the template file that you want to use.

 You can also search the template name in search window (on top of the window).

3. Click **OK** to insert the template.

To insert a data display template in a new data display, create a new file (**File > New**.) and follow the above mentioned steps.

## List of Templates

The following table shows the Product (built-in) templates that are available to facilitate setting up common measurements.

Data Display Template	Description
BJT_curve_tracer	BJT curve tracer with power consumption calculation.
FET_curve_tracer	FET curve tracer with power consumption calculation.
S_ParamsQuad_Smith_Plr	S11, S22 on Smith Charts; S12, S21 on polar plots.
S_Params_Quad_dB_Smith	S11, S22 on Smith Charts; dB(S12), dB(S21) on rect. plots.
S_Params_Quad_dB_Smith_Log	S11, S22 on Smith Charts; dB(S12), dB(S21) on rect. Log plots.
S_ParamsLargeSignal	Displays the S-parameters as a function of frequency and input signal power, as simulated by the S_ParamsLargeSignal schematic template. Is also computes the Rollett stability factor, K, and group delay from these S-parameters.
SProbeT	Use with SProbeT schematic template

## Advanced Design System 2011.01 - Data Display

SProbePairT	Use with SProbePairT schematic template
S_21_11_wZoom	dB(S21), S11 with "zoomed-in" frequency ranges.
Circles_Ga_NF	Available gain and noise figure circles.
Circles_Ga_Stab	Available gain and stability circles.
Circles_Stability	Source and load stability circles and K.
HB1Tone	Output power, gain, and harmonic distortion.
HB1ToneSwptFreq	Output power, gain, harmonic distortion vs. frequency.
HB1ToneSwptPwr	Output power, gain, harmonic distortion vs. power.
HB2Tone	Output power, gain, TOI.
HB2ToneSwptPwr	Output power, gain, TOI vs. power.
MixConvGainNF	Mixer conversion gain, NF, noise contributors.
MixTOI	Mixer output power, conversion gain, TOI.
Name_Date_Dataset	Dataset name, date and time modified, data display name
SP_NWA_T	Use with SP_NWA_T schematic template
SP_NWA_LogT	Use with SP_NWA_LogT schematic template
SP_NWA_4PortT	Use with SP_NWA_4PortT schematic template
SP_NWA_4PortLogT	Use with SP_NWA_4PortLogT schematic template
SP_NWA_4PortBiasT	Use with SP_NWA_4PortBiasT schematic template
SP_NWA_4PortBiasLogT	Use with SP_NWA_4PortBiasLogT schematic template
SP_FET_T	Use with SP_FET_T schematic template
SP_Difft	Use with SP_Difft schematic template
SP_BJT_T	Use with SP_BJT_T schematic template
LinearStepRespT	Use with LinearStepRespT schematic template
LinearPulseRespT	Use with LinearPulseRespT schematic template
DC_FET_T	Use with DC_FET_T schematic template
DC_BJT_T	Use with DC_BJT_T schematic template
ConvStepRespT	Use with ConvStepRespT schematic template
ConvPulseRespT	Use with ConvPulseRespT schematic template
GS_AC	Use with Schematic Wizard template
GS_DC	Use with Schematic Wizard template
GS_Device_FET_LP	Use with Schematic Wizard template
GS_Mix_DI_CG	Use with Schematic Wizard template
GS_Mix_DI_Spect	Use with Schematic Wizard template
GS_Mix_SE_CG_FRFswp	Use with Schematic Wizard template
GS_Mix_SE_CG_LOswp	Use with Schematic Wizard template
GS_Mix_SE_Spect	Use with Schematic Wizard template
GS_Oscillator_LoopGain	Use with Schematic Wizard template
GS_Oscillator_Spect	Use with Schematic Wizard template
YSH_template_1spec	General Design Template for 1 Yield Specification
YSH_template_2specs	General Design Template for 2 Yield Specifications
YSH_template_3specs	General Design Template for 3 Yield Specifications
YSH_template_4specs	General Design Template for 4 Yield Specifications
YSH_template_5specs	General Design Template for 5 Yield Specifications
RF_PAE_DisplayTemplate	WTB, RF PAE With Gating and Markers
RF_PAE_NoGating_DisplayTemplate	WTB, RF PAE With No Gating
RF_PAE_NoMarkers_DisplayTemplate	WTB, RF PAE With Gating, No Markers
RF_PAE_EVM_ACLR_DisplayTemplate	WTB, RF PAE EVM ACLR
3GPPFDD_BS_RX_test	WTB, 3GPPFDD Base Station RX test
3GPPFDD_BS_TX_ACLR	WTB, 3GPPFDD Base Station TX ACLR

Advanced Design System 2011.01 - Data Display

3GPPFDD_BS_TX_CDP	WTB, 3GPPFDD Base Station TX CDP
3GPPFDD_BS_TX_Envelope	WTB, 3GPPFDD Base Station TX Envelope
3GPPFDD_BS_TX_EVM	WTB, 3GPPFDD Base Station TX EVM
3GPPFDD_BS_TX_OccupiedBW	WTB, 3GPPFDD Base Station TX OccupiedBW
3GPPFDD_BS_TX_PCDE	WTB, 3GPPFDD Base Station TX PCDE
3GPPFDD_BS_TX_Power	WTB, 3GPPFDD Base Station TX Power
3GPPFDD_UE_RX_test	WTB, 3GPPFDD User Equipment RX Test
3GPPFDD_UE_TX_ACLR	WTB, 3GPPFDD User Equipment TX ACLR
3GPPFDD_UE_TX_ACLR_ST	WTB, 3GPPFDD User Equipment TX ACLR_ST
3GPPFDD_UE_TX_CDP	WTB, 3GPPFDD User Equipment TX CDP
3GPPFDD_UE_TX_Envelope	WTB, 3GPPFDD User Equipment TX Envelope
3GPPFDD_UE_TX_EVM	WTB, 3GPPFDD User Equipment TX EVM
3GPPFDD_UE_TX_OccupiedBW	WTB, 3GPPFDD User Equipment TX OccupiedBW
3GPPFDD_UE_TX_PCDE	WTB, 3GPPFDD User Equipment TX PCDE
3GPPFDD_UE_TX_Power	WTB, 3GPPFDD User Equipment TX Power
WLAN_802_11a_RX_ACR	WTB, WLAN 802.11a RX ACR
WLAN_802_11a_RX_Sensitivity	WTB, WLAN 802.11a RX Sensitivity
WLAN_802_11a_TX_Constellation	WTB, WLAN 802.11a TX Constellation
WLAN_802_11a_TX_Envelope	WTB, WLAN 802.11a TX Envelope
WLAN_802_11a_TX_EVM	WTB, WLAN 802.11a TX EVM
WLAN_802_11a_TX_Power	WTB, WLAN 802.11a TX Power
WLAN_802_11a_TX_Spectrum	WTB, WLAN 802.11a TX Spectrum
WLAN_802_11b_RX_Sensitivity	WTB, WLAN 802.11b RX Sensitivity
WLAN_802_11b_TX_Constellation	WTB, WLAN 802.11b TX Constellation
WLAN_802_11b_TX_Envelope	WTB, WLAN 802.11b TX Envelope
WLAN_802_11b_TX_EVM	WTB, WLAN 802.11b TX EVM
WLAN_802_11b_TX_Power	WTB, WLAN 802.11b TX Power
WLAN_802_11b_TX_Spectrum	WTB, WLAN 802.11b TX Spectrum
TDSCDMA_UpLnk_RX_Sensitivity	WTB, TD-SCDMA Uplink RX Sensitivity
TDSCDMA_UpLnk_TxConstellation	WTB, TD-SCDMA Uplink TX Constellation
TDSCDMA_UpLnk_TxEnvelope	WTB, TD-SCDMA Uplink TX Envelope
TDSCDMA_UpLnk_TxEVM	WTB, TD-SCDMA Uplink TX EVM
TDSCDMA_UpLnk_TxPower	WTB, TD-SCDMA Uplink TX Power
TDSCDMA_UpLnk_TxSpectrum	WTB, TD-SCDMA Uplink TX Spectrum
TDSCDMA_DnLnk_MultiCarrier_TX_Power	WTB, TD-SCDMA Downlink Multi-Carrier TX Power
TDSCDMA_DnLnk_MultiCarrier_TX_Spectrum	WTB, TD-SCDMA Downlink Multi-Carrier TX Spectrum
TDSCDMA_DnLnk_RX_ACS	WTB, TD-SCDMA Downlink RX ACS
TDSCDMA_DnLnk_TxConstellation	WTB, TD-SCDMA Downlink TX Constellation
TDSCDMA_DnLnk_TxEnvelope	WTB, TD-SCDMA Downlink TX Envelope
TDSCDMA_DnLnk_TxEVM	WTB, TD-SCDMA Downlink TX EVM
TDSCDMA_DnLnk_TxPower	WTB, TD-SCDMA Downlink TX Power
TDSCDMA_DnLnk_TxSpectrum	WTB, TD-SCDMA Downlink TX Spectrum
HSUPA_UE_TX_MaxPower	WTB, HSUPA User Equipment TX Maximum Power
HSUPA_UE_TX_Summary	WTB, HSUPA User Equipment TX Tests Summary
UWB_TX_Spectrum	WTB, UWB TX Spectrum
UWB_TX_Power	WTB, UWB TX Power
UWB_TX_EVM	WTB, UWB TX EVM
UWB_TX_Envelope	WTB, UWB TX Envelope
UWB_TX_Constellation	WTB, UWB TX Constellation

Advanced Design System 2011.01 - Data Display

UWB_RX_Sensitivity_test	WTB, UWB RX Sensitivity
WMAN_DL_802_16e_TX_Constellation	WTB, Mobile WiMAX Downlink TX Constellation
WMAN_DL_802_16e_TX_Envelope	WTB, Mobile WiMAX Downlink TX Envelope
WMAN_DL_802_16e_TX_EVM	WTB, Mobile WiMAX Downlink TX EVM
WMAN_DL_802_16e_TX_Power	WTB, Mobile WiMAX Downlink TX Power
WMAN_DL_802_16e_TX_Spectrum	WTB, Mobile WiMAX Downlink TX Spectrum
WMAN_DL_802_16e_RX_Sensitivity_test	WTB, Mobile WiMAX Downlink RX Sensitivity
WMAN_UL_802_16e_RX_Sensitivity_test	WTB, Mobile WiMAX Uplink RX Sensitivity
WMAN_UL_802_16e_TX_Constellation	WTB, Mobile WiMAX Uplink TX Constellation
WMAN_UL_802_16e_TX_Envelope	WTB, Mobile WiMAX Uplink TX Envelope
WMAN_UL_802_16e_TX_EVM	WTB, Mobile WiMAX Uplink TX EVM
WMAN_UL_802_16e_TX_Power	WTB, Mobile WiMAX Uplink TX Power
WMAN_UL_802_16e_TX_Spectrum	WTB, Mobile WiMAX Uplink TX Spectrum

# Plots and Lists

A variety of plot types can be inserted into a data display so that you can view data in different ways. The different plot types are listed in the table below.

Plot Type	Description
Rectangular	Displays scalar data in a linear or logarithmic format.
Polar	Displays real and imaginary components of complex data on a polar plot.
Smith Chart	Displays real and imaginary components of complex data on a Smith chart.
Stacked	Displays a vertical stack of rectangular plots, each with the same x axis and different y axes.
List	Displays data in columnar format.
<a href="#">Antenna</a>	Displays 2D Far Field simulation results.

You can have more than one plot in a single window. Some plot examples:

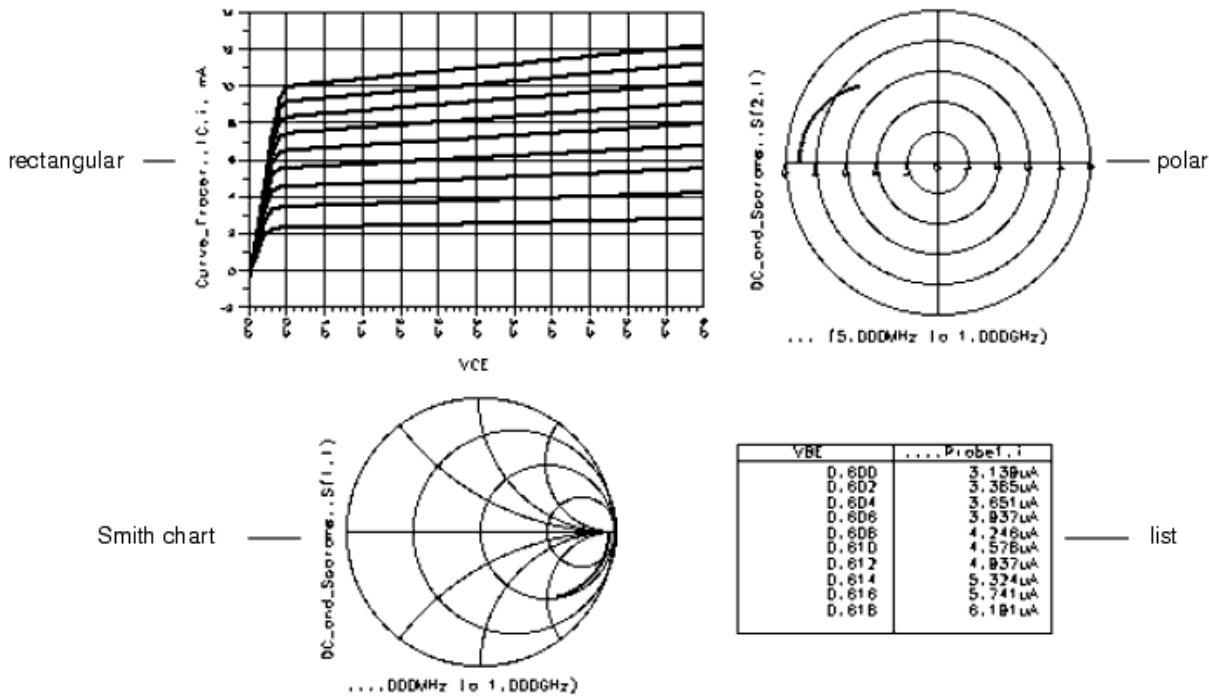

## Inserting Plots

Follow the steps below to insert a plot:

1. From the DDS window, choose **Insert > Plot** or select a plot type from the palette.



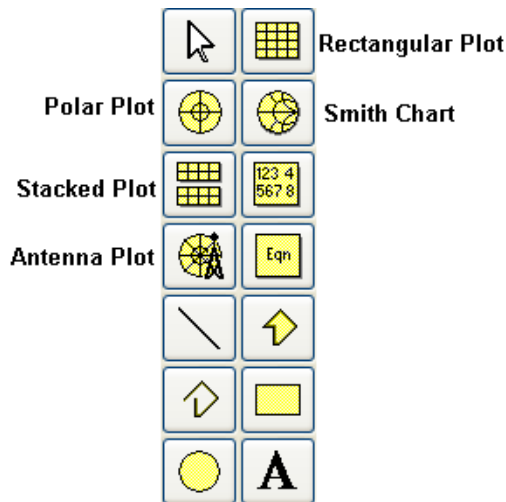

- Position the pointer on the display area. A rectangle image is attached to the pointer which indicates the position and size of the plot.
  - If you are satisfied with the size and position of the rectangle, press the mouse.
  - To change the size of the plot, position the pointer where you want the upper-left corner of the plot, then drag the mouse. When the rectangle is the desired size, release the mouse.
- The **Plot Traces & Attributes** dialog box appears. Plot types are shown across the top and the selected plot type is highlighted. To change to a different plot type, click the desired plot type button.

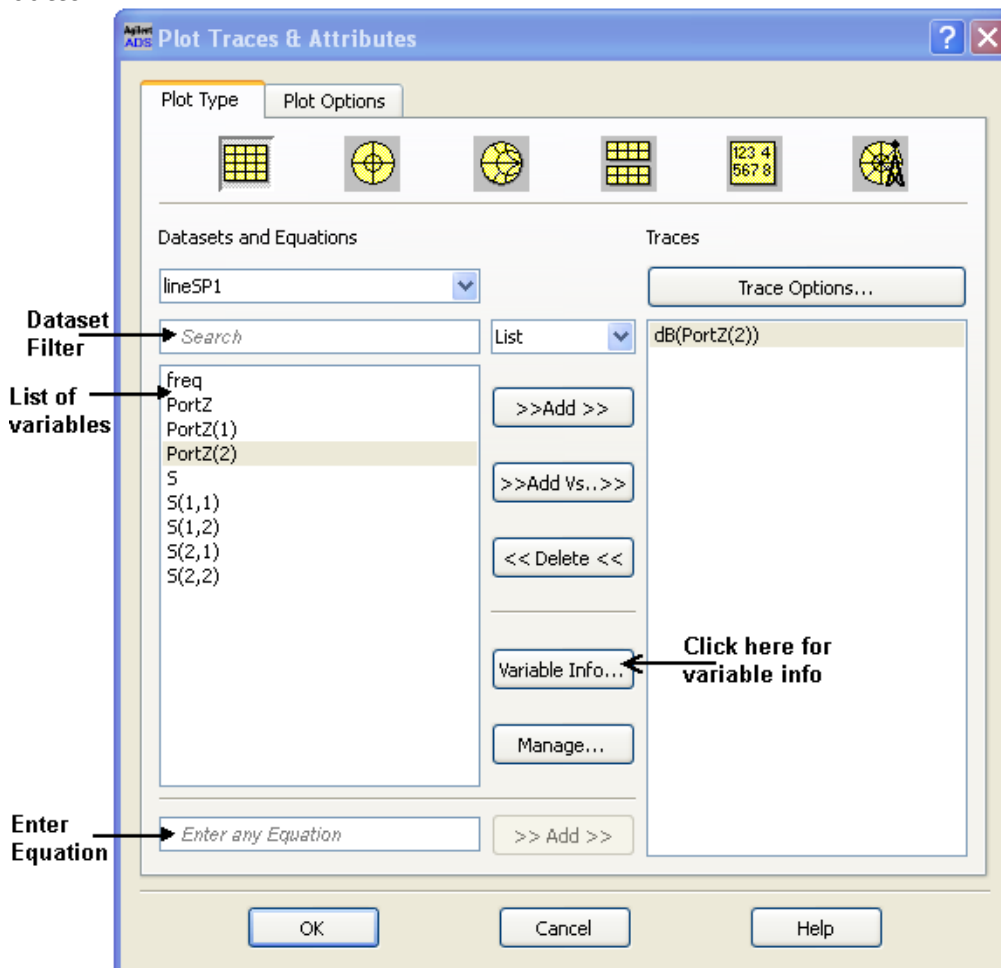

- The lower part of the dialog box contains selections for adding traces to the plot. These are described in *Traces* (data).
- Click the **Plot Options** tab to set up the plot. Options include adding titles and scaling data. Changing options are discussed in the next section.

6. Click **OK** to insert the plot.

## Editing Plots

The title, grid, scale and other attributes can be changed for an existing plot. Any changes that you make will only affect the currently selected plot. To change properties for all plots added subsequently, see [Setting Plot Preferences](#).

### Note

Plot options for the chosen plot type are displayed automatically. If the plot options do not seem correct, click the **Plot Type** tab, click the **Plot** button corresponding to the type of plot you want, then reselect the **Plot Options** tab.

To change the plot type:

1. Double-click the plot.
2. In **Plot Traces & Attributes** dialog box, select a new plot type from the *Plot Type* tab.

To edit various plot characteristics:

1. Double-click the plot of interest, or choose **Edit > Item Options**, and click the *Plot Options* tab.
2. When you are through editing plot characteristics, click **OK** to save the changes.

Most plots use two axes but you can add an additional axis to rectangular plots. To add an additional axis to your rectangular plot:

1. From the *Plot Options* tab, select an axis from the Select Axis list box and click **Add Axis**.
2. In the dialog box that appears, enter a name for the new axis, select the desired orientation and click **OK**.

To add a title above a plot or edit an existing title:

1. From the *Plot Options* tab, enter the desired title in the **Title** field.
2. To change the font, size or color of the title, click **More** and change the characteristics as desired in the dialog box that appears, and click **OK**.

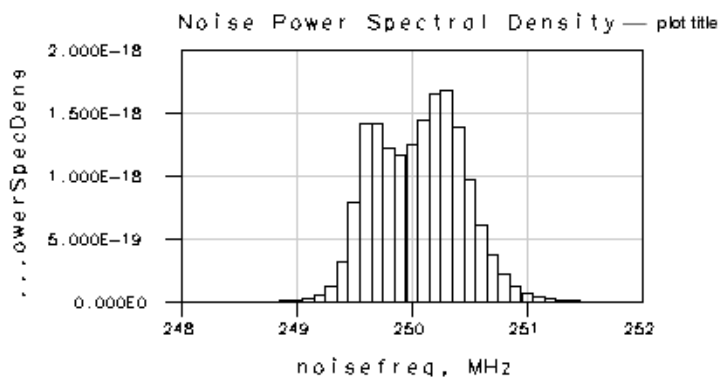

The names of the variables that are displayed on a plot appear along the axes of a plot. The names of the independent and dependent variables are displayed on the x and y axes, respectively. You can format the text along both axes and the numbers on a single axis.

Plots can display the data from multiple independent variables. Each time a trace is added to a plot, a different color is used to draw the trace. The color of the label for that trace matches the color of the

trace to help you identify the source of the data.

The figure shown next displays default axis labels. Note that if you give descriptive names to schematic items such as named connections and variables, as well as to data display equations, you may not need to change the default axis labels.

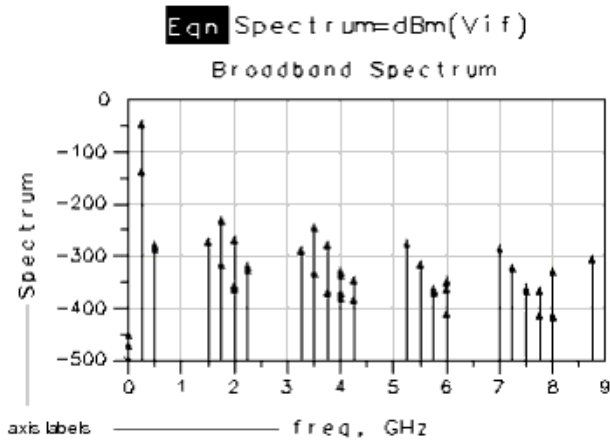

To format a plot's axis labels and numbers:

1. Select the desired axis from the Select Axis list box and type the desired label in the Axis Label field.

**Note**

By default, the names of the independent and dependent variables are displayed as labels along the axes of a plot. If you enter text in the Axis Label field, the variable names along the selected axis will be replaced by this text.

2. Click **More** (to the right of the Axis Label field) to format the label characteristics. The Axis Label dialog box appears.
3. In the Axis Label dialog box, select a *Format* for the numbers along the axis:
  - **Auto** A default format is automatically chosen, based on the type of data to be displayed along the axis.
  - **Full** All digits before the decimal are displayed (i.e., 1530000).
  - **Scientific** Numbers are displayed in scientific format (for example, 1000 is displayed as 1.00e3).
  - **Engineering** Numbers are displayed using engineering notation. For example, frequency values end in Hz. Additionally, numbers are displayed in powers of  $10^3$  (for example, 1000 Hz is displayed as 1.0 kHz).
  - **Hex** Numbers are displayed in hexadecimal (base 16).
  - **Octal** Numbers are displayed in octal (base 8).
  - **Binary** Numbers are displayed in binary (base 2).

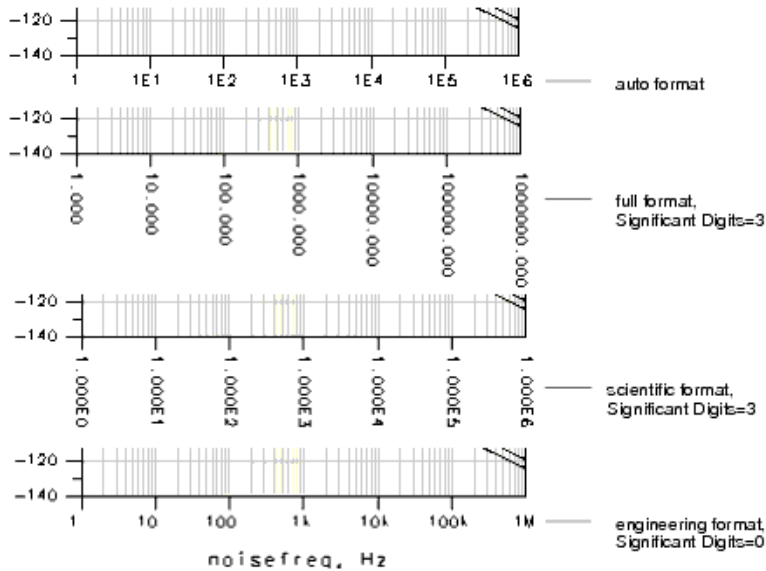

- In the field to the right of the Format drop-down list, enter the desired # of *Decimal Digits* (for Full) or *Significant Digits* (for Scientific, Engineering, Hex, Octal, Binary). When *Auto* is the selected Format, the number of digits after the decimal is chosen automatically; any value in the # of *Decimal Digits* field is ignored.
- Select the desired font from the *Font Type* list.
- Select the desired font size from the *Font Size* list.
- Click the **Color** bar to select a new text color and click **OK**.

**Note**  
If you set this to a color other than black, all labels will be displayed in this color.

- Click **OK** to dismiss the Axis Label dialog box.

The scale on rectangular and stacked plots and Smith charts can be set to linear or logarithmic format. The scale can also be different along each axis.

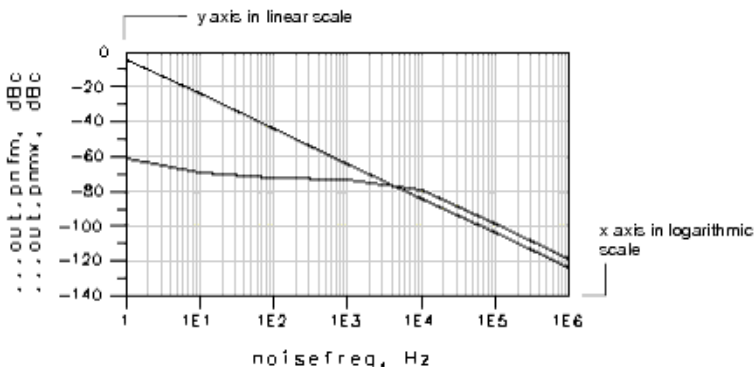

To change the scale format, do the following:

- Select the desired axis from the Select Axis list box.
- Select the **Auto Scale** option.
- Select either **Linear** or **Log** as the *Scale* type.
- Select the other axis, as appropriate, and change its scale in a similar manner.

The data display automatically scales plot axes to display the entire range of a variable on the plot and give an optimum view of the data.

- For rectangular and stacked plots, you can manually set the start and endpoints of a plot to show a limited range of data.
- On polar plots and Smith charts, you can specify the radius of the plot and the range of data for

the independent variable.

**Note**  
 You can scroll through traces that have more data than what is displayed on the plot. Select the trace, then use the scroll buttons on the toolbar to scroll through the trace. For more information on scrolling, refer to *Scrolling through Lists and Traces* (data).

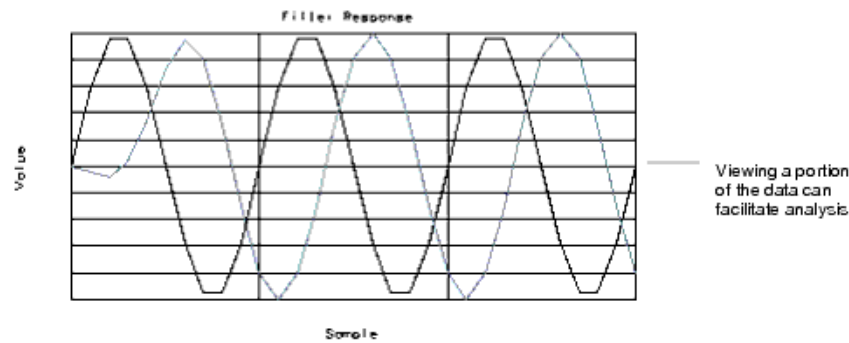
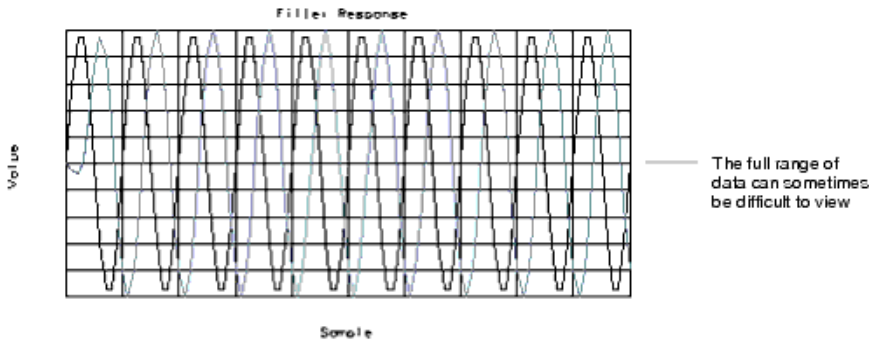

To manually scale a plot, do the following:

1. Select the axis that you want to scale from the Select Axis list box.
2. Deselect the **Auto Scale** option.
3. Enter the starting value for the selected axis in the *Min* field.
4. Enter the ending value for the selected axis in the *Max* field. For Smith plots, this is the maximum radius of the plot.
5. Enter the incremental value in the *Step* field (rectangular, stacked, and polar plots only). Grid lines are drawn on this axis at these intervals.
6. For polar and Smith charts only, to limit the range of data displayed, deselect **Display All** and enter the minimum and maximum values in the Start and Stop fields, respectively.

**Note**  
 For Smith charts only, the coordinates can be changed by selecting *Impedance*, *Admittance*, or *Both* from the Coordinate drop-downlist.

The type, thickness, and color of lines in a grid can be changed. On rectangular plots and stacked plots, horizontal lines and vertical lines can have different properties. The same is true for impedance and admittance lines on Smith charts.

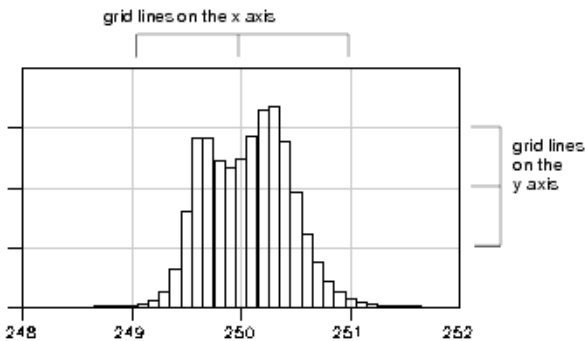

To edit a plot's grid :

1. For rectangular and stacked plots, select an axis from the Select Axis list box. Select the X axis to format the vertical lines of the grid; select the Y axis to format horizontal lines. For stacked plots, the Y axis on each plot must be formatted individually.
2. Click **Grid**. If the plot is a rectangular, polar, or stacked rectangular plot, you can modify the grid attributes. For Smith charts, you can edit either the impedance or admittance lines.
3. Select a line type (solid, dot, dash, etc.) from the Type drop-down list.
4. Select a line thickness either by using the slider or by entering a value in the Points field. Thickness can range from 0 to 10 points. The larger the value, the thicker the line will be drawn.
5. Click the **Color** bar, select a new color, then click **OK**.
6. Click **OK** to dismiss the Grid dialog box.

You can remove the grid from a plot. To remove the grid:

1. Click **Grid**. The Grid dialog box is displayed.
2. Deselect the **Display Grid** option.
3. Click **OK** to dismiss the Grid dialog box.

## Editing

Plot Axis Scales

The scale of a plot axis can be changed directly from a rectangular, polar, or stacked rectangular plot by using the following steps:

1. Click on the first or last number label on the axis and enter a new value (on polar plots, you can only change the outer-most number label).

### Note

The value you enter in the number label depends on the unit of measure used for the axis. For example, if the x-axis uses "freq (GHz)" as the unit of measure, typing **9** in the number label would result in the label having a value of "9 GHz" rather than "9".

2. Press **Return** or click anywhere in the Data Display window to make the scale change take effect.

## Deleting Plots

To remove a plot, do the following:

1. To delete a single plot, single-click on the plot. For multiple plots, hold the **Shift** key down and single-click on each plot of interest.
2. Press the **Delete** key or choose **Edit > Delete**.

### Note

If you just want to disable a plot temporarily, refer to *Activating or Deactivating Objects (data)*.

## Setting Plot Preferences

Plot preferences set the default plot properties and determine the appearance of a plot in the display area. Preferences affect all plot types and include setting the font type, size, and color for titles and axis labels; the numeric format of axis labels; and the line type, width, and color of grids.

Plot preference changes will apply to all plots created after the changes were made and saved. To change the properties for an existing plot, refer to [Editing Plots](#).

Data display preference settings can be saved for reuse by creating a preferences file. For more information on how to create and use such a file, refer to *Setting Data Display Preferences (data)*.

To set plot preferences, use the following steps:

1. Choose **Options > Preferences**.
2. The Preference dialog box appears. Click the **Plot** tab followed by the **Main** tab.
3. To set the plot title attributes, do the following:
  - Select a font from the Font Type list.
  - Select a font size from the Font Size list.
  - Click the **Text Color** bar, select a color, then click **OK**.
4. The axis numbers can be formatted for plots that use more than one axis. This is done as follows:
  - Select an axis label format from the Label Format list. The choices are:
    - Auto** A default format is automatically chosen, based on the type of data to be displayed along the axis.
    - Full** All digits before the decimal are displayed (i.e., 1530000).
    - Scientific** Numbers are displayed in scientific format (for example, 1000 is displayed as 1.00e3).
    - Engineering** Numbers are displayed using engineering notation. For example, frequency values end in Hz. Additionally, numbers are displayed in powers of  $10^3$  (for example, 1000 Hz is displayed as 1.0 kHz).
    - Hex** Numbers are displayed in hexadecimal (base 16).
    - Octal** Numbers are displayed in octal (base 8).
    - Binary** Numbers are displayed in binary (base 2).
  - To the right of the Format drop-down list, enter the desired *# of Decimal Digits* (for Full) or *Significant Digits* (for Scientific, Engineering, Hex, Octal, Binary). When *Auto* is the selected Format, the number of digits after the decimal is chosen automatically; any value in the *# of Decimal Digits* field is ignored.
5. To format axis label text, click the **Label** button and make the following selections from the Axis Labels dialog box:
  - Select a font from the Font Type list.
  - Select a font size from the Font Size list.
  - Click the **Text Color** bar, select a new color, then click **OK**.

 **Note**  
If you set this to a color other than black, all labels will be displayed in this color.

  - Click **OK** to dismiss the Axis Label dialog box.
6. To set grid preferences, click **Grid** and make the following selections in the Grid dialog box:
  - Select a line pattern from the Type list.
  - Select a line thickness either by using the scroll bar or by entering a value into the Points field. Thickness can range from 0 to 10 points. If 0 points is selected, a very thin line is drawn.
  - Click the **Color** bar, select a new color, then click **OK**.
  - Select a Smith chart admittance line pattern from the Type list.
  - Select a Smith chart admittance line thickness by using the scroll bar or entering a value into the Points field. Thickness can range from 0 to 10 points. If 0 points is selected, a very thin line is drawn.
  - Select a Smith chart admittance line color by clicking the **Color** bar, selecting a new color, then clicking **OK**.
  - Click **OK** to dismiss the Grid dialog box.
7. To set the axis scale for linear and stacked plots, click the **Linear, Stack** tab and select **Linear** or **Log**.
8. To set the coordinates used on Smith charts, click the **Smith** tab and select **Impedance**,

**Admittance**, or **Both** from the Coordinate list.

9. Click **OK** to dismiss the Preference dialog box and save the changes.

## Antenna Plot

Antenna Plot provides a platform to display the Far Field data generated from Momentum that allows you to plot generic magnitude and phase data. It also supports the display of arbitrary magnitude and angle (degree) data.

Key features of Antenna Plot include:

- Displays radiation patterns generated from ADS simulators.
- DDS automatically checks for the independent data and display the data in the correct Antenna Plot.
- Theta and Phi data can be placed on the same plot. However, the first trace will determine the 0 degree orientation of the plot.
- Option to change the Min and Max values of magnitude to be displayed on the plot.
- Control over the step size used to create the concentric circles from the center of the plot.
- Control over the degrees of separation between radial grid lines specified in degrees.
- Values outside the plot's last radius are the degree values.
- Min/Max values of the magnitude values can be edited on screen.
- Magnitude values are displayed from center of the plot vertically regardless of 0 degree orientation.

Figure: Antenna Plot showing the planar cut with Theta as the independent data.

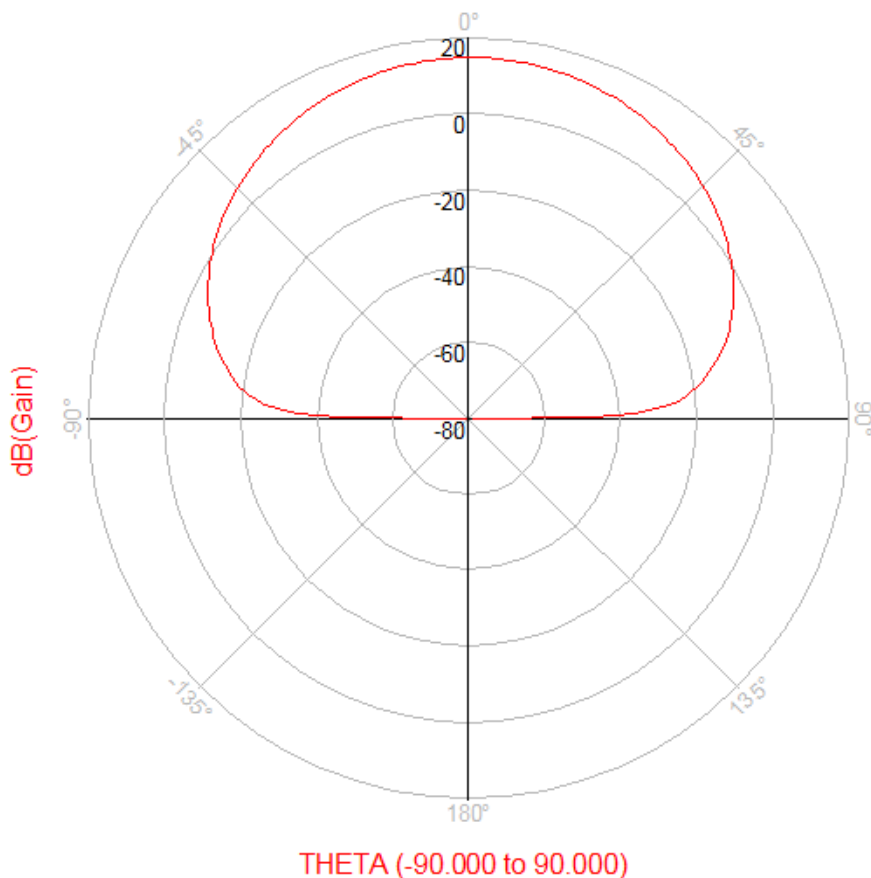
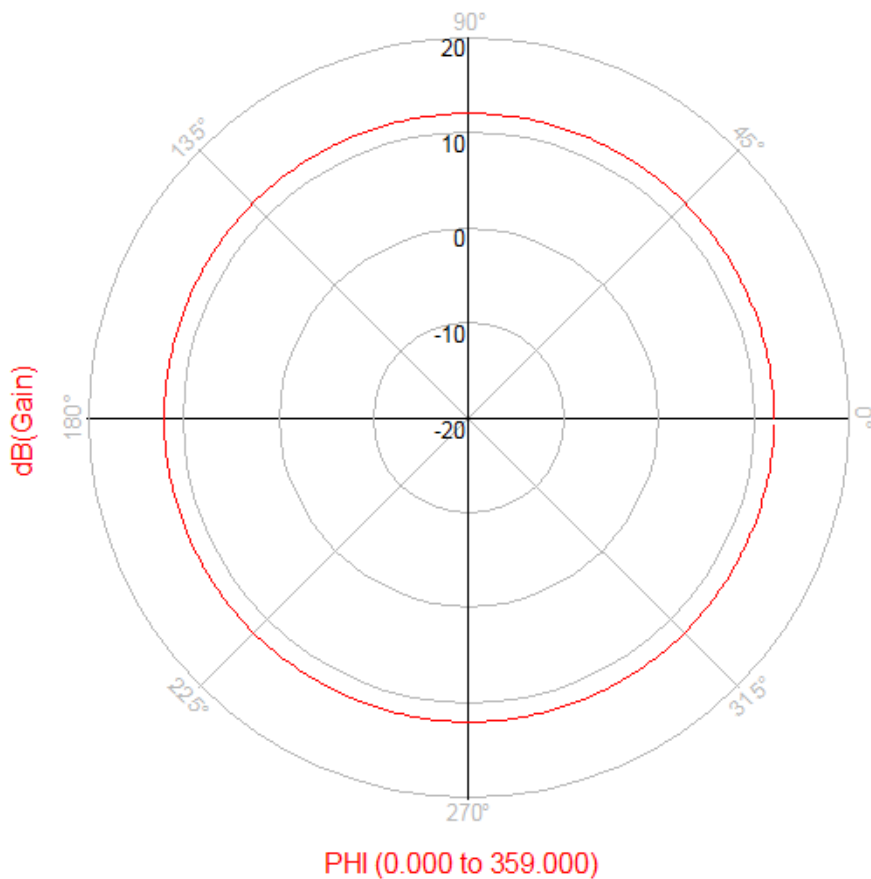

Figure: Antenna Plot showing the conical cut with Phi as the independent data.





## Plot Options

The "Plot Options" tab provides the following options to customize various display options of the Antenna plot:

1. *Title*: To change the plot title.
2. *Dependent Axis (Magnitude)*: To change the display options of dependent axis.
3. *Independent Axis (Degree)*: To change the display options of independent axis.
4. *Auto Scale*: To change the scaling options.
5. *Independent Variable*: To change the independent variables, Theta or Phi, Start and Stop options.

**Figure: Plot Traces and Attributes - Antenna Tab**

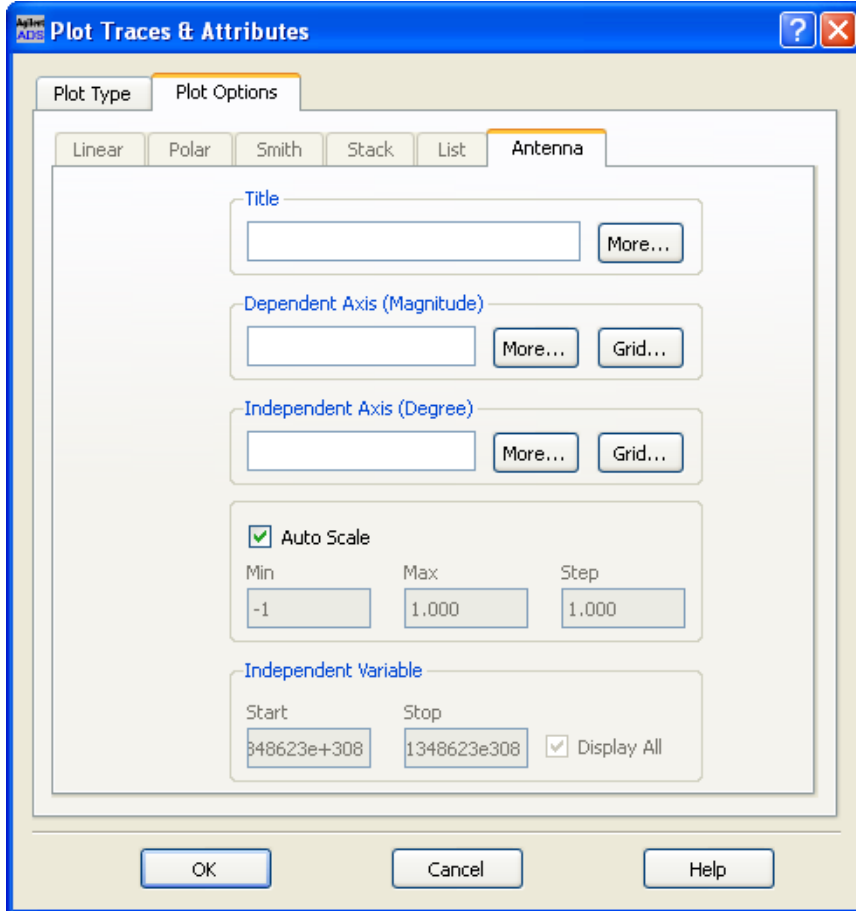

## Title

Here you can provide the title to Antenna Plot. Click the More button to change the font style of plot title.

## Dependent Axis (Magnitude)

To change the display options of dependent axis, click the More or Grid button.

Figure: Dependent Axis More Button Dialog

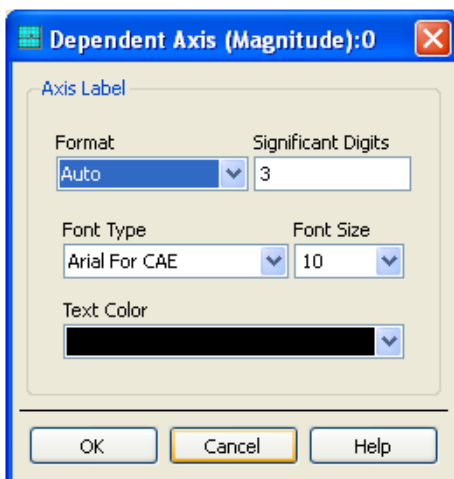

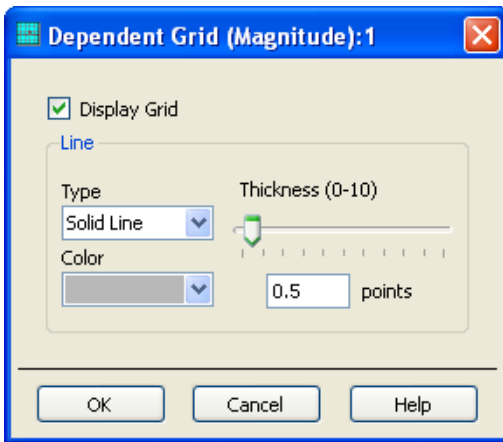
**Figure: Dependent Axis Grid Dialog**

## Independent Axis

To change the display options of independent axis, click the More or Grid button.

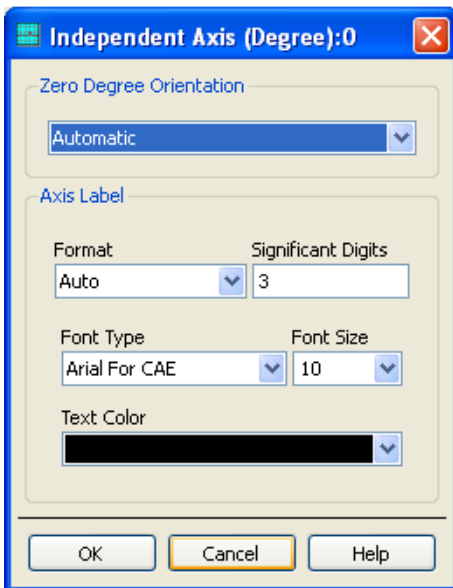
**Figure: Independent Axis More Dialog**

The Zero Degree Orientation drop down list contains the following:

- Automatic
- Vertical (Planar Cut)
- Horizontal (Conical Cut)

When in Automatic mode, the orientation is controlled by the independent data.

## Grid Dialog

The Grid dialog allows you to control how often to display a radial grid line. The default value is 45 degree. Other supported values are: 10, 15, 30, 45 and 90 degrees.

**Figure: Independent Axis Grid Dialog**

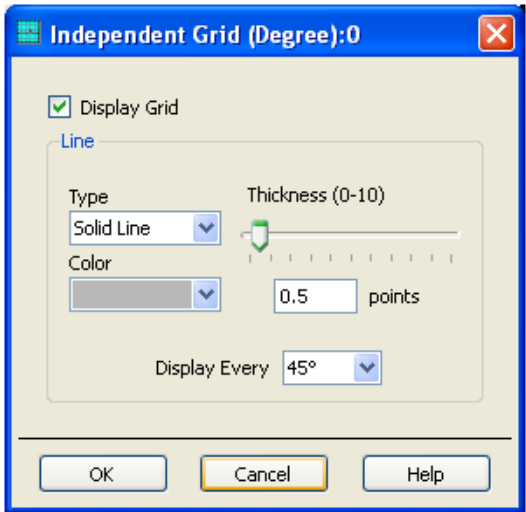

## Antenna Complex Data Dialog

The data inserted in Antenna Plot is usually complex. Since Antenna plot supports only scalar data you will be prompted to choose an equation to convert the data into scalar data. The following dialog is displayed when you select the equation to apply:

Figure: Data Conversion Dialog

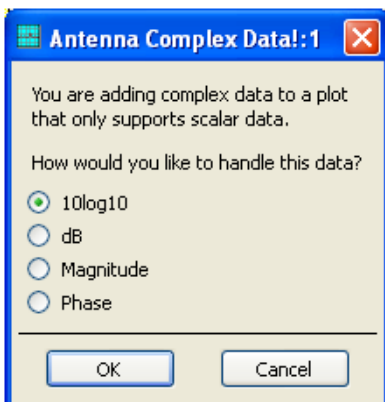

## Inserting Lists

To insert a list, do the following:

1. Select **List** from the palette or choose **Insert > Plot**.

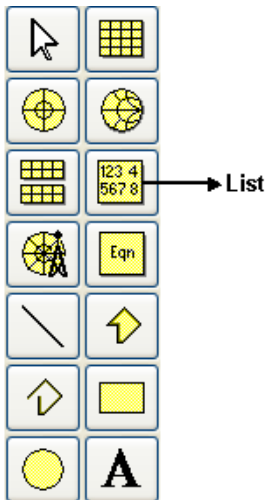

- Position the pointer on the display area. A ghost image of a rectangle is attached to the pointer. It indicates the position and size of the list.  
If you are satisfied with the size and position of the rectangle, click the mouse.  
If you want to customize the size of the list, position the pointer where you want the upper-left corner of the list, then drag the mouse. When the rectangle is the desired size, release the mouse.
- The Plot Traces & Attributes dialog box appears. Plot types and list icon are shown across the top. If the List icon is not highlighted, select it.

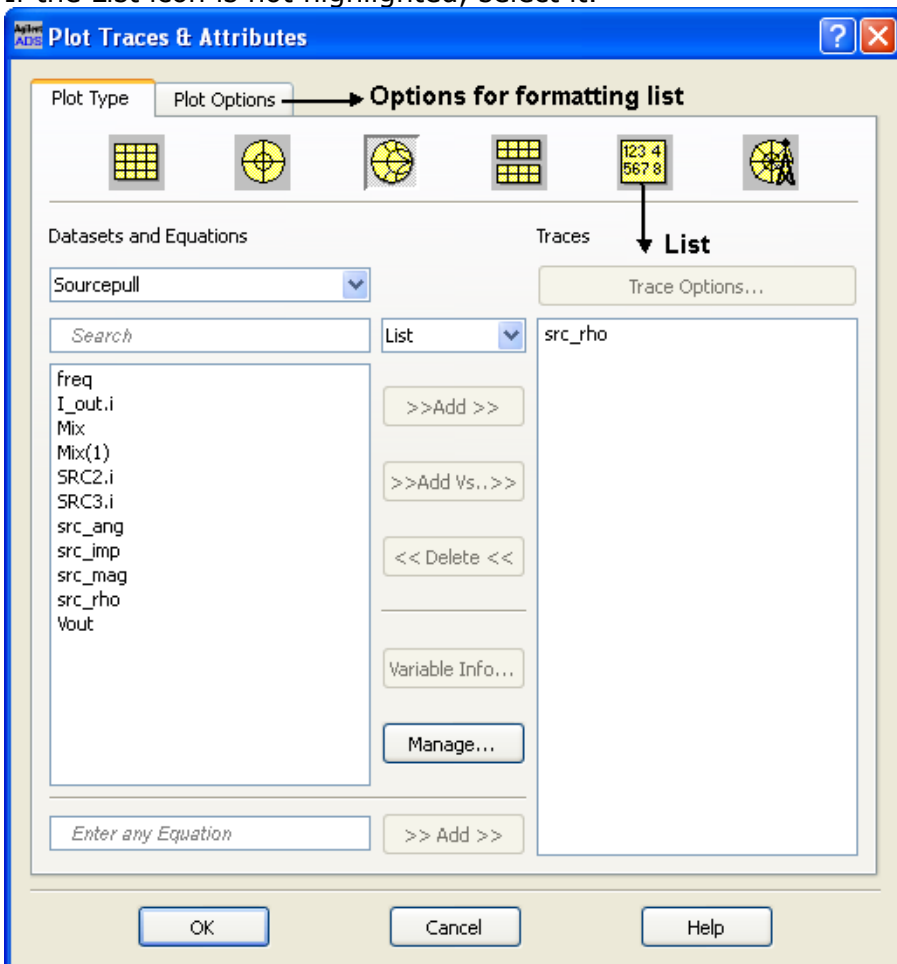

- Click the **Plot Options** tab to set up the list. Options are provided for formatting the data. Changing list options are discussed in the next section.
- Click **OK** to dismiss the dialog box and insert the list.

## Editing Lists

Except for titles, lists have options that are not common to the other plot types. You can change these list settings:

- Numeric format of data displayed in lists
- Text format of data, such as font type and color
- Format of the lines that outline a list
- Display of column headings
- Display of data in table format

Any changes that you make will only affect the currently selected list. To change the properties for all subsequently created lists, refer to [Setting List Preferences](#).

To edit a list, do the following:

1. Double-click on the list.
2. The Plot Traces & Attributes dialog box appears. Click the **Plot Options** tab.
3. To specify the numeric format of the data, do the following:
  - Select a format for the data from the Format drop-down list. The choices are:
    - Auto** A default format is automatically chosen based on the type of data displayed.
    - Full** All digits before the decimal are displayed (for example, 1530000).
    - Scientific** Numbers are displayed in scientific format. For example, 1000 is displayed as 1.00e3.
    - Engineering** Numbers are displayed using engineering notation. For example, frequency values end in Hz. Also, numbers are displayed in powers of  $10^3$  (1000 Hz is displayed as 1.0 kHz).
    - Hex** Numbers are displayed in hexadecimal (base 16).
    - Octal** Numbers are displayed in octal (base 8).
    - Binary** Numbers are displayed in binary (base 2).
  - To the right of the Format drop-down list, enter the desired *# of Decimal Digits* (for Full) or *Significant Digits* (for Scientific, Engineering, Hex, Octal, Binary). When *Auto* is the selected Format, the number of digits after the decimal is chosen automatically; any value in the *# of Decimal Digits* field is ignored.

### Note

If columns are too narrow to display data correctly, an ellipsis (...) appears in the data. To widen the columns, select the list and drag the lower-right or lower-left handle horizontally.

4. To change the type font, size, and color of list text, do the following:
  - Click **Listing Text**.
  - Make the following selections from the Column Listing dialog box:
    - Select a font from the Font Type list
    - Select a font size from the Font Size list.
    - Click **Text Color**, select a color, then click **OK**.
  - Click **OK** to dismiss the Column Listing dialog box
5. The type, color, and thickness of the line around the perimeter of a list can be changed by following these steps:
  - Click **Outline**.
  - Make these selections from the Outline dialog box:
    - Select a line pattern from the Type list.
    - Select a line thickness either by using the Thickness scroll bar or by entering a value into the Points field.
    - Click **Color**, select a new outline color, then click **OK**.
  - Click **OK** to dismiss the Outline dialog box.
6. Column headings display the name of the variable that is the source of the data. They are

- displayed by default. To remove them, deselect **Display Column Headings**.
7. Table format is only used to display data with two independent and one dependent variable. It is chosen automatically. To disable table format, select **Suppress Table Format**.
  8. If you use table format, you can also transpose the data, which reverses the position of the two independent variables. This is recommended if the independent variable data listed across the table has more values than the independent variable data listed down the table. Transposing would give you a longer, narrower table.

To transpose tabular data, select **Transpose Data**.

In the example below, the two independent variables are *VCE* and *IBB*. The measured data is *IC.i*. The first list is in table format, which is the default and generally the best way to display data. The second list uses table format and transposed data, note the change of position between *VCE* and *IBB*. The third list is in suppressed table format, both independents are displayed in one column.

VCE	Curve_Tracer..IC.1[0:3,0:5]			
	IBB=2.000E-5	IBB=3.000E-5	IBB=4.000E-5	IBB=5.000E-5
0.000	-0.000	-0.000	-0.000	-0.000
0.100	0.001	0.001	0.001	0.001
0.200	0.002	0.003	0.003	0.003
0.300	0.002	0.003	0.004	0.005
0.400	0.002	0.003	0.004	0.005
0.500	0.002	0.003	0.004	0.006

table format (default)

IBB	Curve_Tracer..IC.1[0:3,0:5]					
	VCE=0.000	VCE=0.100	VCE=0.200	VCE=0.300	VCE=0.400	VCE=0.500
2.000E-5	-0.000	0.001	0.002	0.002	0.002	0.002
3.000E-5	-0.000	0.001	0.003	0.003	0.003	0.003
4.000E-5	-0.000	0.001	0.003	0.004	0.004	0.004
5.000E-5	-0.000	0.001	0.003	0.005	0.005	0.006

IBB	VCE	Curve_Tracer..IC.1[0:3,0:5]			
	IBB=2.000E-5	0.000	-0.000	0.001	0.002
	0.100	0.001	0.002	0.003	0.003
	0.200	0.002	0.003	0.004	0.005
	0.300	0.002	0.003	0.004	0.005
	0.400	0.002	0.003	0.004	0.005
	0.500	0.002	0.003	0.004	0.006
IBB=3.000E-5	0.000	-0.000	0.001	0.003	0.003
	0.100	0.001	0.003	0.004	0.004
	0.200	0.003	0.004	0.005	0.005
	0.300	0.003	0.004	0.005	0.006
	0.400	0.003	0.004	0.005	0.006
	0.500	0.003	0.004	0.005	0.006
IBB=4.000E-5	0.000	-0.000	0.001	0.003	0.003
	0.100	0.001	0.003	0.004	0.004
	0.200	0.003	0.004	0.005	0.005
	0.300	0.004	0.005	0.006	0.006
	0.400	0.004	0.005	0.006	0.007
	0.500	0.004	0.005	0.006	0.007
IBB=5.000E-5	0.000	-0.000	0.001	0.003	0.003
	0.100	0.001	0.003	0.004	0.004
	0.200	0.003	0.004	0.005	0.005
	0.300	0.005	0.006	0.007	0.007
	0.400	0.005	0.006	0.007	0.008
	0.500	0.005	0.006	0.007	0.008

table format, transposed data

table format suppressed

9. Click **OK** to dismiss the dialog box and save the changes.

## Deleting Lists

To remove a list, do the following:

1. To delete a single list, single-click the list. For multiple lists, hold the **Shift** key down and single-click on each list of interest.
2. Press the **Delete** key or choose **Edit > Delete**.

**Note**  
If you just want to disable a list temporarily, refer to *Activating or Deactivating Objects (data)*.

## Setting List Preferences

List preferences set the default list properties and determine the appearance of a list in the display area. List preference changes will affect all lists created after the changes were made and saved. To edit the properties of an existing plot, refer to [Editing Lists](#).

To set list preferences, follow these steps:

1. Choose **Options > Preferences**.
2. The Preference dialog box appears. First select the **Plot** tab followed by the **List** tab.
3. To specify the numeric format of the data, do the following:
  - Select a format for the data from the Format drop-down list. The choices are:
    - Auto** A default format is automatically chosen based on the type of data displayed.
    - Full** All digits before the decimal are displayed (i.e., 1530000).
    - Scientific** Numbers are displayed in scientific format (for example, 1000 is displayed as 1.00e3).
    - Engineering** Numbers are displayed using engineering notation. For example, frequency values end in Hz. Also, numbers are displayed in powers of  $10^3$  (for example, 1000 Hz is displayed as 1.0 kHz).
    - Hex** Numbers are displayed in hexadecimal (base 16).
    - Octal** Numbers are displayed in octal (base 8).
    - Binary** Numbers are displayed in binary (base 2).
  - To the right of the Format drop-down list, enter the desired *# of Decimal Digits* (for Full) or *Significant Digits* (for Scientific, Engineering, Hex, Octal, Binary). When *Auto* is the selected Format, the number of digits after the decimal is chosen automatically; any value in the *# of Decimal Digits* field is ignored.



### Note

If columns are too narrow to display data correctly, an ellipsis (...) appears in the data. To widen the columns, select the list and drag the lower-right or lower-left handle horizontally.

4. To change the type font, size, and color of list text, do the following:
  - Click **Listing Text**.
  - Make the following selections from the Column Listing dialog box:
    - Select a font from the Font Type list
    - Select a font size from the Font Size list.
    - Click **Text Color**, select a color, then click **OK**.
  - Click **OK** to dismiss the Column Listing dialog box
5. The type, color, and thickness of the line around the perimeter of a list can be changed by following these steps:
  - Click **Outline**.
  - Make these selections from the Outline dialog box:
    - Select a line pattern from the Type list.
    - Select a line thickness either by using the Thickness scroll bar or by entering a value into the Points field.
    - Click **Color**, select a new outline color, then click **OK**.
  - Click **OK** to dismiss the Outline dialog box.
6. Column headings display the name of the variable that is the source of the data. They are displayed by default. To remove them, deselect **Display Column Headings**.
7. Table format is only used to display data with two independent and one dependent variable. It is chosen automatically. To disable table format, select **Suppress Table Format**.
8. If you use table format, you can also transpose the data, which reverses the position of the two independent variables. To transpose tabular data, select **Transpose Data**.
9. Select a complex data format from the Complex Data List. The choices are:
  - Real/Imaginary** Real and imaginary values.
  - Mag/Degrees** Magnitude and angle in degrees.



**dB/Degrees** The dB value and angle in degrees.

**Mag/Radians** The magnitude and angle in radians.

**dB/Radians** The dB value in radians.

10. Click **OK** to dismiss the Preference dialog box and save the settings.

## Using Legends

Legends are provided in Data Display to help you quickly identify specific traces in a plot. Often times, sub-trace labels will appear placed on top of each other making it difficult, if not impossible, to identify values assigned to a particular sub-trace. Legends can also help to identify a traces associated with specific expressions.

Legends are especially helpful in ADS tuning sessions where it is important to keep track of the various traces associated with specific tuning parameters. For more information on ADS tuning, refer to *Tuning, Optimization, and Statistical Design* (optstat).

## Inserting a Legend

There are two methods available for inserting a legend. The first method is the pre-select method and enables you to add legends to more than one plot at a time. The second method, or post-select method only allows you to add one legend to a single plot.

To insert a legend using the pre-select method,

1. Click the plot that you want to attach a legend to.
2. Choose **Insert > Plot Legend**. The legend object always appears to the right of the plot. You can then move the legend to any desired location.

[Examples of Different Trace Formats](#) shows an example of a plot that uses different trace formats displayed in a legend.

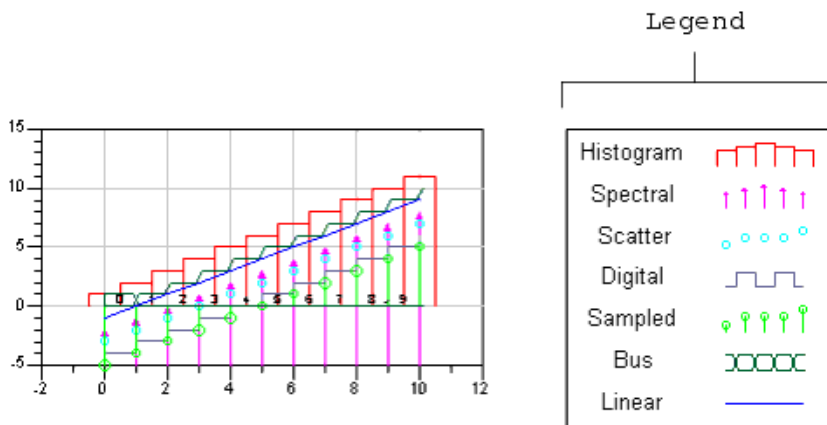

### Examples of Different Trace Formats

To insert a legend using the post-select method,

1. Choose **Insert > Plot Legend**.

- Click the plot that you want to attach a legend to. The legend object always appears to the right of the plot. You can then move the legend to any desired location.

## Deleting a Legend

Removing an existing legend is easy.

- Simply click the legend that you want to remove to activate the legend.
- Press the Delete key. The legend is removed.

## Changing Legend Fonts and Font Size

To change the font and/or font size used in your legend,

- Right-click the legend you want to change.
- Select Text from the pop-up menu.
- Select a new Font or Font size from the available options.  
You can perform the same actions by choosing the **Edit > Text** pull-down menu item.

## Changing Legend Formats

There are two types of legend formats available for changing the legend display format, the *Indented* legend format and the *Normal* legend format.

- Indented legend format is used to reduce the width of the legend by collapsing common columns into a single width header. Indented legend format is the default for legends that have duplicate adjacent data in a column and can help when you have long header or equation names.
- Normal legend format is used when columns in the legend do not have duplicate adjacent data. See the figure [Examples of Indented and Normal Legend Formats](#) for examples of both types of legend formats.

To select the Normal legend format,

- Click the legend you want to change.
- Choose **Edit > Legend > Format > Normal**. The legend format is changed to Normal.
- To return to the Indented legend format, simply choose **Edit > Legend > Format > Indented**. The plot pop-up menu item also includes legend format capability under the *Insert Legend* menu item. You can also access this capability from the Legend pop-up menu.

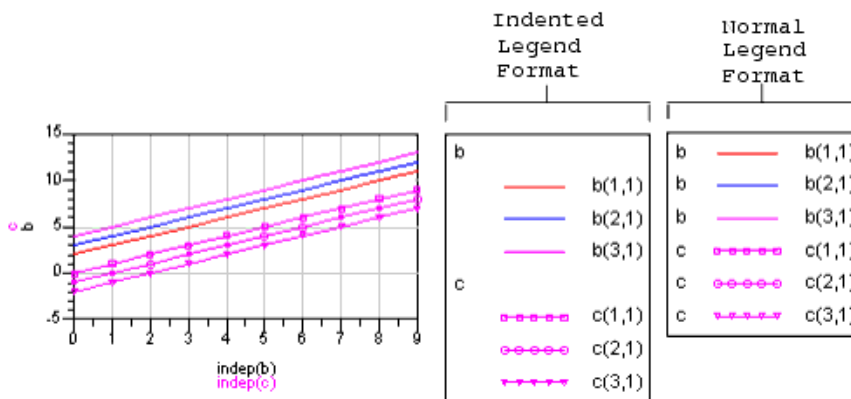

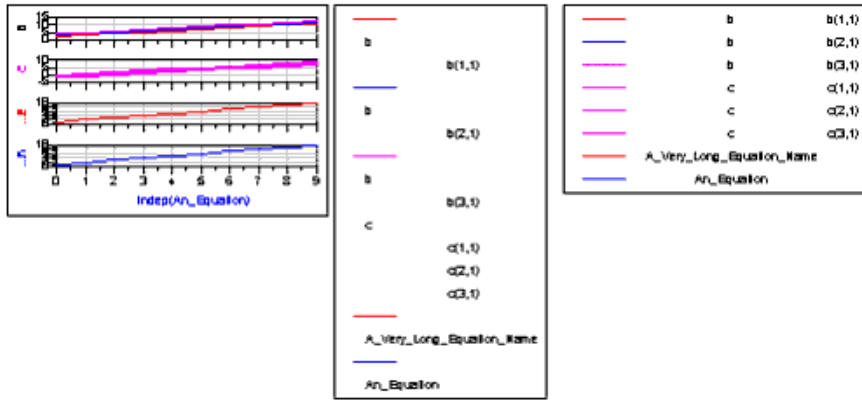

**Examples of Indented and Normal Legend Formats**

# Traces

Traces are used to display the data that is stored in a dataset and the results of equations. There are several trace formats available for displaying data. Selecting various combinations of traces and plot types enable you to analyze simulation results in a variety of ways. Typical trace types are listed in the table below.

Trace Type	Description
Auto	A default trace type that is assigned to the data during simulation is automatically selected.
Bus	Displays bus or long-word data in octal, decimal, or hexadecimal format.
Linear	Displays data as a line. Points between measured data points are interpolated linearly to create a connected trace.
Scatter	Displays data as discrete points.
Spectral	Each data point is represented as an arrow that is perpendicular to the x-axis, the base of each arrow is on the x-axis, and each arrow points in the positive direction.
Histogram	Displays data as a histogram or bar chart, which is useful for statistical or yield analyses.
Digital	Displays data in a stair format, similar to a digital pulse. The trace steps up or down depending upon the relative position of two adjacent points.
Sampled	Similar to a spectral trace, except that vectors point in the positive and negative direction, and you can specify the type of symbol used on the ends of the vectors.
Density	Displays swept data in different colors. You can choose the colors and sequence for colors.

Because an automatic trace type is selected for data, you can view simulation results with little effort. If you want to analyze data in different ways, you can choose other formats or use equations to perform computations with data. For more information, refer to *Equations (data)*.

Examples of traces are displayed below.

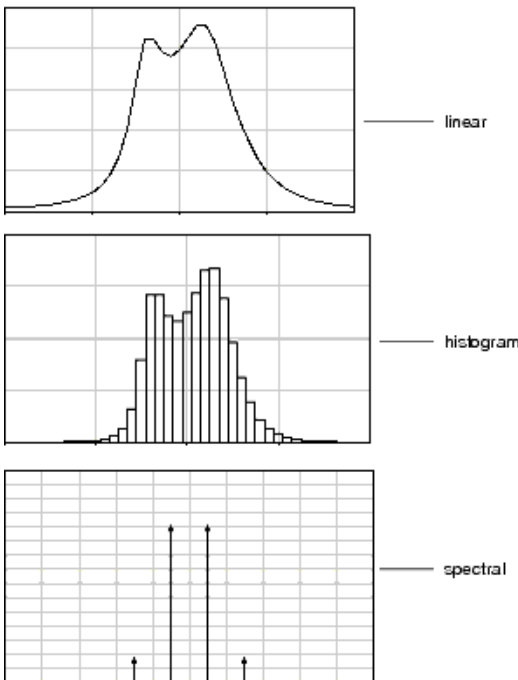

## Inserting a Trace

You can add a trace as you create a new plot, or you can add a trace to an existing plot.  
To insert a trace onto a plot:

1. Double-click on an existing plot or create a new plot by selecting a plot type from the palette, positioning the pointer over the display area, and clicking the mouse.
2. The Plot Traces & Attributes dialog box appears. Select the dataset containing the data from the Datasets and Equations drop down list. There are two other choices:
  - Select **Equations** from the **Datasets and Equations** list to display the results of an equation on a plot. For more information, see *Equations* (data).
  - Click **Manage** to set up an alias to display data in datasets that are not in the current workspace. For more information, see *Dataset Aliasing* (data).

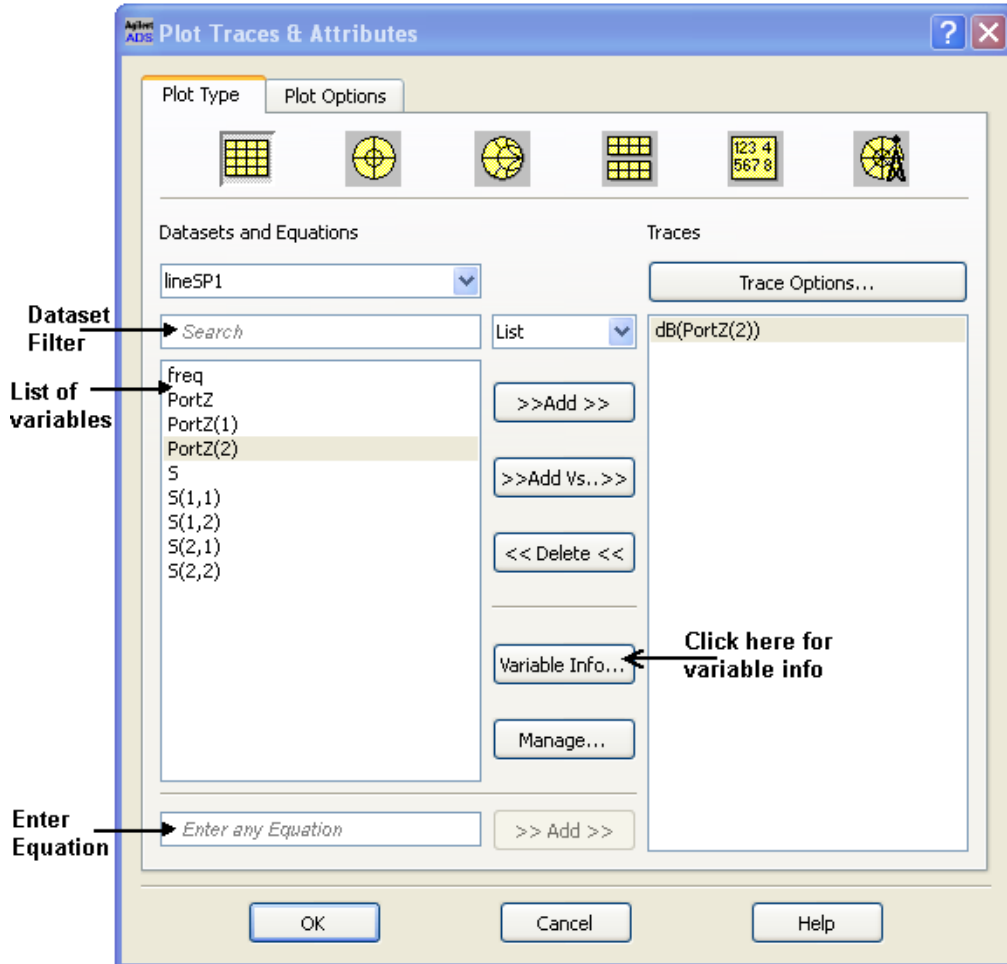

3. The variables in the dataset are listed under the dataset name. To add a variable to the plot, double-click on the variable or select the variable and click **>>Add >>** button. The selected variables appear under the **Traces** list.
4. A trace type for each selected variable is automatically chosen based on the type of data in the variable. You can select a different trace type or change trace attributes such as color.
5. Click **OK** to insert the trace and return back to previous window.

## Selecting Independent and Dependent Variables

When **>>Add >>** button is used to add data to a plot, the data is plotted with respect to the independent variable of a simulation. For example, transient simulations are a function of time, so any data from a transient simulation that is added to a plot using **>>Add >>** would be plotted with respect to time.

If you want to use an independent variable other than the default, use **>>Add Vs..>>** to add data to

a plot. Note that the dependent variable must be the same length or size as the independent variable when using **>>Add Vs..>>** to add data to a plot. Not doing so will result in an invalid trace. You can use **>>Add Vs..>>** with rectangular plots and with lists. For rectangular plots, you select the variables to be plotted along the x-axis and y-axis. For lists, the independent and dependent variables appear in two separate columns.

Follow the steps below to compare two variables:

1. To compare two variables on a new plot, choose **Insert > Plot**, position the pointer, and click or select a plot type from the palette. To compare two variables on an existing plot, double-click on the plot. The **Plot Traces & Attributes** dialog box appears.
2. If this is a new plot, select a plot type.
3. For new and existing plots, select the dependent variable from the list below Datasets and Equations and click **>>Add Vs..>>**.
4. If you are using a rectangular plot and the dependent variable you selected is a complex number, the Complex Data dialog box will appear. Select how the data is to be handled and click **OK**.
5. The Select Independent Variable dialog box appears. Select the independent variable from the list. It can be from a different dataset or equation. Click **OK**.
6. If the independent variable you selected is a complex number, the Complex Data dialog box will appear. Select how the data is to be handled and click **OK**.
7. Click **OK** to dismiss the Plot Traces & Attributes dialog box and display the trace on the plot.

## Dataset Filtering

Dataset filter provide an option to interactively search the variables in the dataset by filtering the characters entered in the search box. The variables are interactively filtered as the user types into the search box allowing the user to see the results as they type. The Dataset filter is available in both the List and Hierarchy variable display modes.

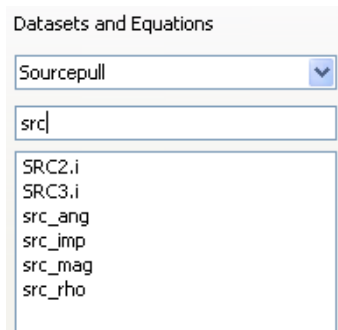

## Viewing Complex Data on a Rectangular Plot

The data from frequency-domain simulations, such as S-parameter or harmonic balance simulations, is stored in complex format. You can plot data from these simulations on rectangular plots, but you must scale the data to one of the following formats:

- dB
- dBm
- Magnitude
- Phase
- Real
- Imaginary

When you select the data and click **Add** or **Add Vs**, if the data must be scaled the dialog box shown

below will automatically appear. Select a format and click **OK**, and continue with the plot as usual.

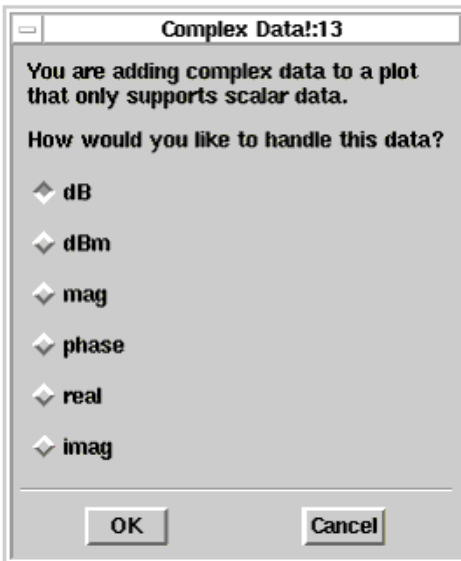

When adding one trace at a time, additional checking is performed based on the simulation type of the selected trace. For example, if a trace is associated with a swept harmonic balance simulation is selected and you click the **>>Add >>** button, the following dialog appears:

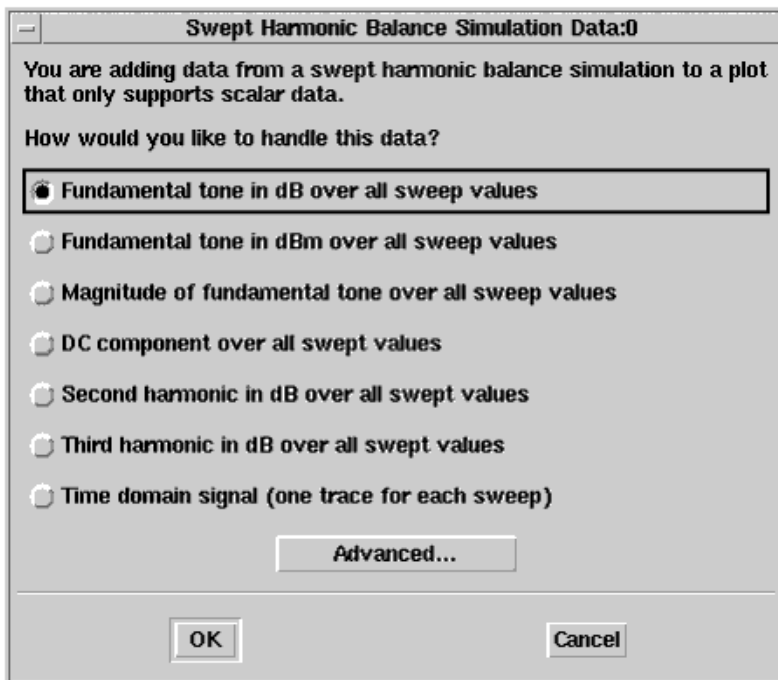

**i** This additional check is made only when a single trace is selected. When several traces are selected, the check for the type of data being plotted is more general.

## Editing Traces

Trace options enable you to choose different trace formats and change trace attributes. If the trace is generated from an equation, you can also edit the equation.

The Trace Options dialog box is used to modify existing traces. Any changes made from this dialog box will only affect the currently selected trace. To change the options for all subsequent traces, refer to [Setting Trace Preferences](#).

**Note**  
Trace options for the chosen trace type are displayed automatically. If the trace options do not seem correct, click the Trace Type tab, click the button corresponding to the type of trace you want, then reselect the Trace Options tab.

To edit trace options:

1. Double-click on the trace or select the trace and choose **Edit > Item Options**.
2. The **Trace Options** dialog box appears.

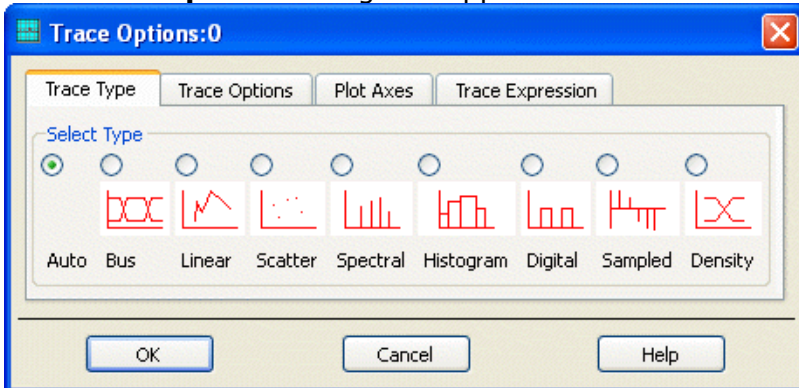

3. Select the **Trace Type** tab and click the button above the desired trace type.

The suggested plot-trace combinations are:

Plot Type	Trace Types
Rectangular and Stacked	Any type
Polar	Linear and Scatter
Smith Charts	Linear and Scatter
List	None. Data is formatted from Plot Options

4. You can keep the Auto trace type and still edit the attributes of the trace. Generally, the correct trace options will be displayed automatically. If you are not sure about the trace type or options, perform the following steps:
  - Click the **Trace Options** tab followed by the **Auto** tab.
  - Note the trace type shown in the Auto tab.
5. The pattern, thickness, and color of a trace can be changed for all trace types except scatter. To modify a trace line, make the following selections:
  - Click the **Trace Options** tab followed by the tab that matches the trace type.
  - Select a line pattern from the Type list.
  - Select a line thickness by using the scroll bar or entering a value into the Points field.
  - Click the **Color** bar, select a new color, then click **OK**.
6. In addition to editing the trace of a histogram, and you can also fill the histogram with a pattern. The color of the fill will be the same as the trace color. To fill a histogram:
  - Click the **Trace Options** tab followed by the **Histogram** tab.
  - Enable **Use Fill Pattern**.
  - Click the **Pattern** bar, select a fill pattern, then click **OK**.
7. The type and number of symbols shown on a trace can be changed. Symbols are used with linear, scatter, and sampled traces to identify the data points that were measured during a simulation. To modify the frequency of symbols (for linear traces only), make the following selections:
  - Click the **Trace Options** tab followed by the tab that matches the trace type.
  - For linear traces, symbols can be displayed for some or all data points. Enable **Auto Space Symbols** (symbols are added for a subset of data points, selected to avoid overlap on the screen), or **Place Symbols at all Data Points** (symbols are added for all data points, regardless of overlap), or **No Symbols**.



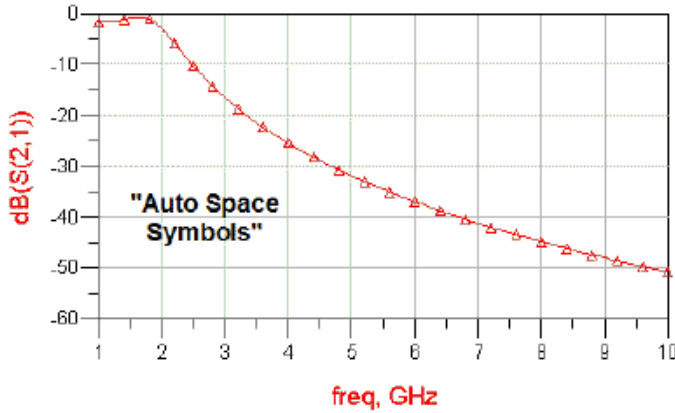
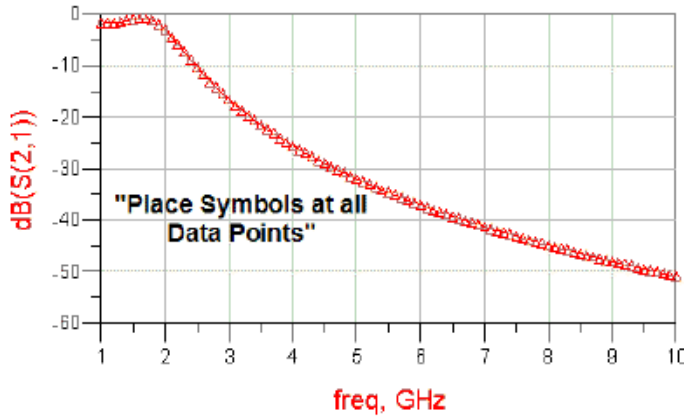

- Select a symbol from the Symbol Type list.
  - Click **OK**.
8. The Data Display enables you to change the text properties and numeric format used in bus traces. This is done by clicking the **Trace Options** tab followed by the **Bus** tab and making the following selections:
- Select a format for the data from the Format list. The choices are:
    - Auto** A default format is automatically chosen based on the data to be displayed.
    - Dec** Numbers are displayed in decimal (base 10).
    - Hex** Numbers are displayed in hexadecimal (base 16).
    - Octal** Numbers are displayed in octal (base 8).
    - Binary** Numbers are displayed in binary (base 2).
  - Select a font from the Font Type list.
  - Click the **Text Color** bar, select a color, then click **OK**.
9. The Data Display trace labels are disabled by default. Trace labels are added to the display for linear and digital traces with subtraces (such as the curve tracer display) or plots with more than one independent variable along the x-axis.

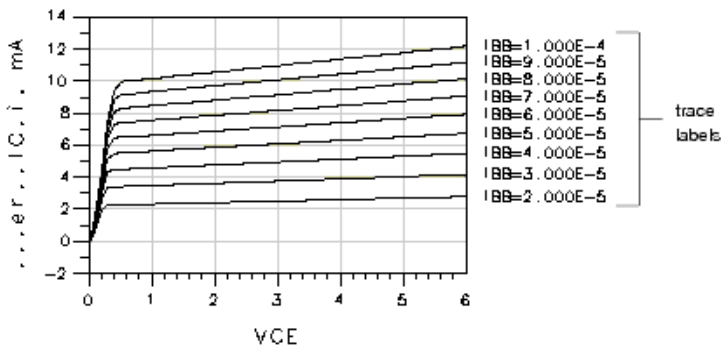

To turn on trace labels, do the following:

- Click the **Trace Options** tab followed by the tab that matches the trace type.
  - Select **Display Label**.
10. Data Display also provides options for displaying swept data (subtraces). These options are controlled by using the checkboxes in the **Automatic Sequencing** section of the Trace Options

dialog box. For more information, refer to [Setting Trace Preferences](#).

11. When you have finished editing the trace, click the **OK** button to close the Trace Options dialog box and save the changes.

## Deleting Traces

To remove a trace from a plot, do the following:

1. To delete a single trace, single-click on the trace. For multiple traces, hold the **Shift** key down and single-click on each trace of interest.
2. Press the **Delete** key or choose **Edit > Delete**.

Sometimes it is difficult to select a trace from a plot with multiple traces because the traces overlap. If you have trouble selecting a trace, use the steps listed below:

1. Double-click on the plot.
2. The Plot Traces & Attributes dialog box appears.
3. Under Traces, select the variables used to generate the trace.
4. Click **Delete**.
5. Click **OK** to dismiss the dialog box and delete the trace.

## Setting Trace Preferences

Trace preferences set the default trace properties and determine how traces will appear when inserted onto a plot.

Any changes made to the preferences will only affect subsequently created traces. To change an option for an existing trace, make the change using the Trace Options dialog box.

To save and reuse preference settings, you can create a preferences file that can be read by the data display. For more information on how to create and use such a file, refer to *Setting Data Display Preferences* (data).

To set trace preferences, use the following steps:

1. Choose **Options > Preferences**.
2. The Preference dialog box appears.
3. Click the **Main** tab. Set the trace line and symbol preferences by making the following selections:
  - Select a line pattern from the Type list.
  - Select a line thickness by using the scroll bar or entering a value into the Points field.
4. Click the **Bus** tab. Set the bus trace text and numbering preferences by using these steps:
  - Select a format for the data from the Format list. The choices are:
    - Auto** A default format is automatically chosen based on the data to be displayed.
    - Dec** Numbers are displayed in decimal (base 10).
    - Hex** Numbers are displayed in hexadecimal (base 16).
    - Octal** Numbers are displayed in octal (base 8).
    - Binary** Numbers are displayed in binary (base 2).
  - Select a font from the Font Type list.
  - Click the **Text Color** bar, select a color, then click **OK**.
5. Click the **Symbols** tab. Set the label and symbol preferences by doing the following:
  - If you want to display labels, enable **Display Label**.
  - Select **Display Arrowheads On Spectral Traces** if you want arrowheads to appear on the measured data points on spectral traces.
  - If you want symbols to appear on the measured data points on linear traces, select **Auto**

**Space Symbols** (symbols are added for a subset of data points, selected to avoid overlap on the screen), or **Place Symbols at all Data Points** (symbols are added for all data points, regardless of overlap). The default setting is **No Symbols**.

- Select a symbol type from the Symbol Type list. This is the default symbol for linear, scatter, and sampled traces.
6. Click the **Histogram** tab and set the histogram fill preferences by doing the following:
    - Enable **Use Fill Pattern**.
    - Click the **Pattern** bar, select a fill pattern, then click **OK**.
  7. Click the **Parameter Sweeps** tab and set the options that control the appearance of swept data (subtraces). The **Automatic Sequencing** options are:
    - **Line Type** - Overrides the default *Line Type* of the trace and automatically uses different line types for each sweep of the data.
    - **Symbol Type** - Overrides the default *Symbol Type* of the trace and automatically uses a different symbol for each sweep of the data.
    - **Line Color** - Overrides the default *Line Color* of the trace and automatically uses different colors for each sweep of the data.

One or all of the *Automatic Sequencing* options described above can be enabled at any one time. If all three options are selected, the order in which they are sequenced is Line Type, Symbol Type and Line Color.

**Note**

The Automatic Sequencing options only apply to linear data. If you check more than one option, you will not see sequencing for the next option start until you have exhausted the previous option. There are many line and symbol types. Be aware that if you check all three options, trace color won't start to change until over a hundred subtraces exist, which is not a practical configuration.

8. When you have finished setting preferences, click the **OK** button to close the Preference dialog box and save the changes.

## History Traces

History traces enable you to perform a series of sequential simulations and have the resulting traces conveniently displayed in a single Data Display window.

You can turn trace history on, pause it, or turn it off completely. You can also have history mode enabled on some traces or plots, and disabled on others.

To enable history traces, select the plots or traces for which you want history traces gathered and then:

- Choose **History > On** in the Data Display Window  
OR
- Right-click and select **History On** from a popup menu

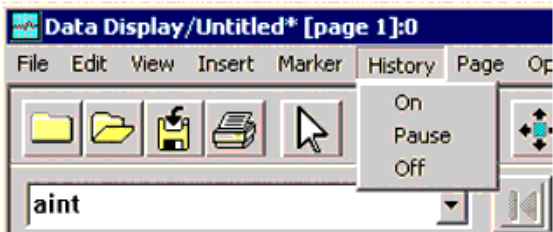

**Note**

If no plots and/or traces are pre-selected when you choose **History > On** in the Data Display window, history mode is enabled on all plots and traces in the window.

When history mode is enabled, an indicator appears at the top right hand corner of the plot and at the end of the axis label. The indicator on the plot is green when history is being gathered and red when

history is paused. The indicator at the end of the axis label does not change color.

In history mode, the most recent data collected is represented by a thicker trace, and all previous traces become thinner.

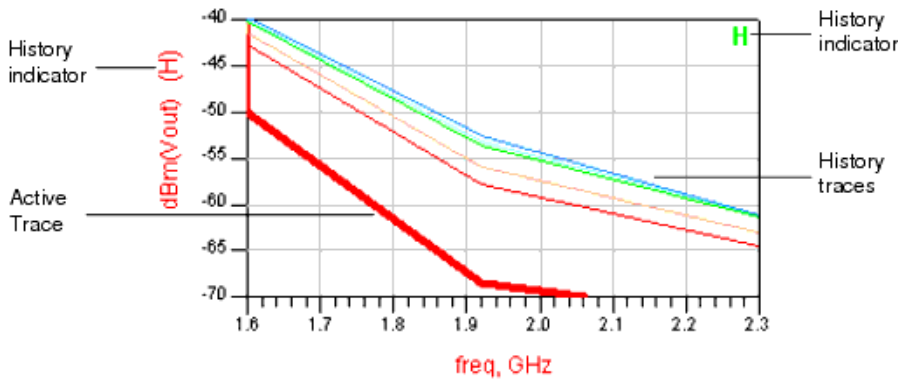

To pause the gathering of trace history, choose *History > Pause* from the Data Display window menu.

To disable history traces, choose *History > Off* from the Data Display window menu. This command disables history mode and clears all existing history traces in the Data Display window.

You can change the default number of history traces displayed using the Preference dialog box. Choose **Options > Preferences** in the Data Display window, and use the History Traces area in the Main tab to change the number of traces.

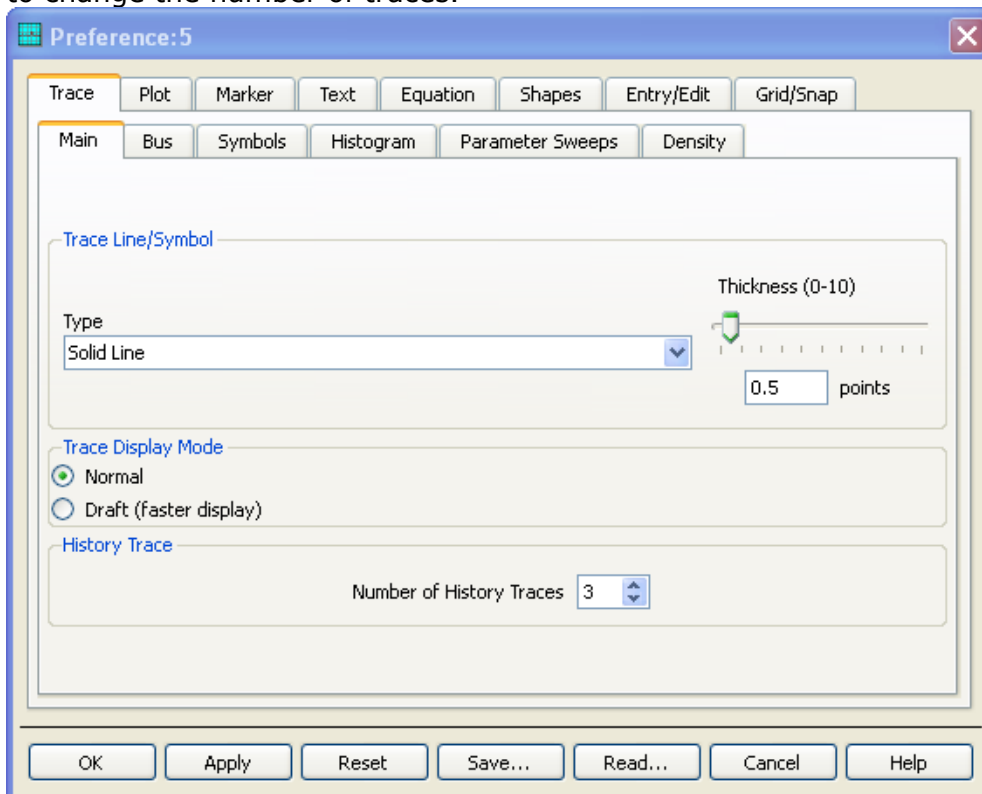

**Note**  
History traces are available to you as display only, and only for the duration of the session. Unlike the active trace, you cannot place markers on history traces, edit or save them.

## Memory Traces

Memory Traces are primarily used in Advanced Design System tuning. For more information on using memory traces, see *Tuning, Optimization, and Statistical Design* (optstat).

# Equations

Equations perform complex mathematical operations on data. You can display equations results on data display plots, enabling you to analyze information in various ways.

This section describes how to write equations and how to display the results. It includes examples of how to use some of the mathematical expressions that are in Advanced Design System. A reference of the functions that are available can be found online, it can be accessed from the *Equations* dialog box.

Equations can be simple or very complex. An equation can include:

- Mathematical expressions and operations
- Functions
- Other data display equations
- Dataset variables
- Dataset information
- Marker labels

The rules for writing expressions are minimal:

- Equations are case-sensitive
- Equation names cannot start with a digit
- All functions must be completed using the given syntax
- Parentheses are used to define order of operation
- Reserved names cannot be used as equation variables. For example, you cannot use *mag* as the variable `mag=[1 : :3]`. Instead, it would need to be used as `mymag=[1 : :3]` or something similar.

## Inserting Equations

To insert an equation on the data display:

1. Click the Equation button from the palette or choose **Insert > Equation**.
2. Position the pointer on the display area and click the mouse. The Enter Equation dialog box appears.

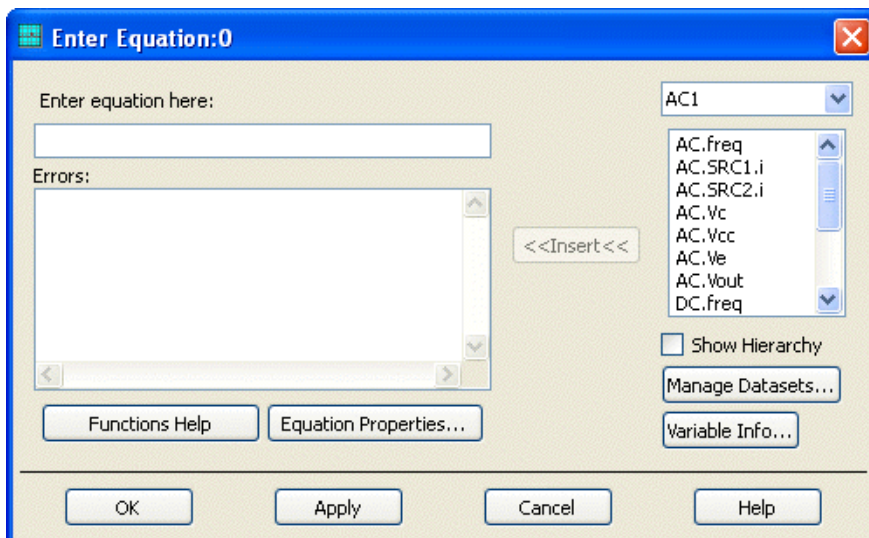

3. Enter an equation with the equation variable name on the left side and the expression on the

right. A sample equation is shown below.

$$\text{RL}_1 = \text{dB}(\text{DC\_and\_Sparams.S}(1,1))$$

Equation variable
Function
Dataset name
Dataset variable

The expression can include any of the items in the previous list. Note that the *Dataset name* is not required if the *Dataset variable* is included in the default dataset.

Click the **Functions Help** button for an alphabetical list of links to the available measurement functions. Click the *Index* tab in the left-hand frame of the *Measurement Expressions* documentation for an optional method of scrolling through the list of functions.

**Note**

Only the functions described in the " *Measurement Expressions*" documentation should be used to write Data Display equations.

4. To add a dataset variable to the equation, position the cursor in the equation where you want to insert the variable.
5. Select the dataset name from the list box.
6. A list of variables in the dataset is presented. Select a variable from this list and click **Insert**.
7. To modify the display properties of an expression, click **Equation Properties**. For more information, refer to *Editing Text* (data).
8. Activate the *Show Hierarchy* checkbox to display the dataset variables in a tree format. For more information, refer to *Using the Dataset Browser* (data).
9. Click the **Manage Datasets** button to locate a dataset that is not available in the current workspace. For more information, refer to *Dataset Aliasing* (data).
10. Click the **Variable Info** button to access the Browse Data dialog box. If you click a dataset variable in the list box of the Browse Data dialog box, detailed information about the dataset variable is displayed on the right-hand section of the dialog. For more information, refer to [Viewing Variable Information](#).
11. When the equation is complete, click **OK**.

**Note**

If you entered an equation incorrectly, a warning message will appear and the equation identifier, *Eqn*, is displayed in the color red (if an equation is correct, this is displayed in the color black).

## Shortening Variable Names

When using variables in the default dataset, the dataset variable names can be shortened to make an equation easier to read, as long as each name remains unique. For example, if the variable is entered as:

Curve\_Tracer.Sweep1.DC1.DC.IC.i

If this variable is in the default dataset, you can erase everything from the last period back and keep IC.i

If you want to use a variable with the same name, but from another dataset in the workspace, you cannot delete part of the name of either variable. Variable names must be unique.

If you enter data from datasets that are outside the workspace, the full file path is entered. You may want to keep the full path or you can erase the part of the file path that is common with the current workspace.

## Viewing Data From Multiple Datasets

The default dataset list only allows you to refer to a single dataset. If you have several equations you can easily change the referenced datasets by defining string variables with a dataset name and referring to the string variable in the equations. For example:

```
MeasuredData="measured"
MeasS21=db\($MeasuredData..S\{2, 1}\)
DiffS21=MeasS21 - SimS21
SimulatedData="simulated"
SimS21=db\($SimulatedData..S\{2, 1}\)
```

## Inserting Conditional Expressions

DDS Equation editor also allows you to enter conditional expressions. You can make use of *if then else* statement as shown in the following example:

```
if ( argument > 1 ) then cplx(0,0) else b1 endif
```

### Note

The data type returned from "if" statement must be of same type to display it correctly. This can be done by using the "cplx()" function to return the 0 data.

## Viewing Equation Results

Equation results can be plotted or displayed in a list. You treat results like any other data. You can apply markers, edit the format, or use the results of an equation within another equation.

To view the results of your equation:

1. Click the **Equation** button on the palette or choose **Insert > Equation**.
2. Position the pointer on the display area and click the mouse to display the Enter Equation dialog box.
3. Select **Equations** from the Datasets and Equations list.
4. Select the equation variable and click the **Insert** button.  
If the equation is entered incorrectly, an error indication is displayed. Some types of equation errors cause the equation ( *Eqn* ) identifier on the Data Display to be highlighted in red. Other errors will cause the error dialog box to appear. This dialog box provides specific information about the error.
5. The default trace type for the chosen data will be used. If you want to verify or change the trace type, click **Trace Options** and proceed to edit the trace.
6. Click **OK** to dismiss the dialog box and display the equation results.



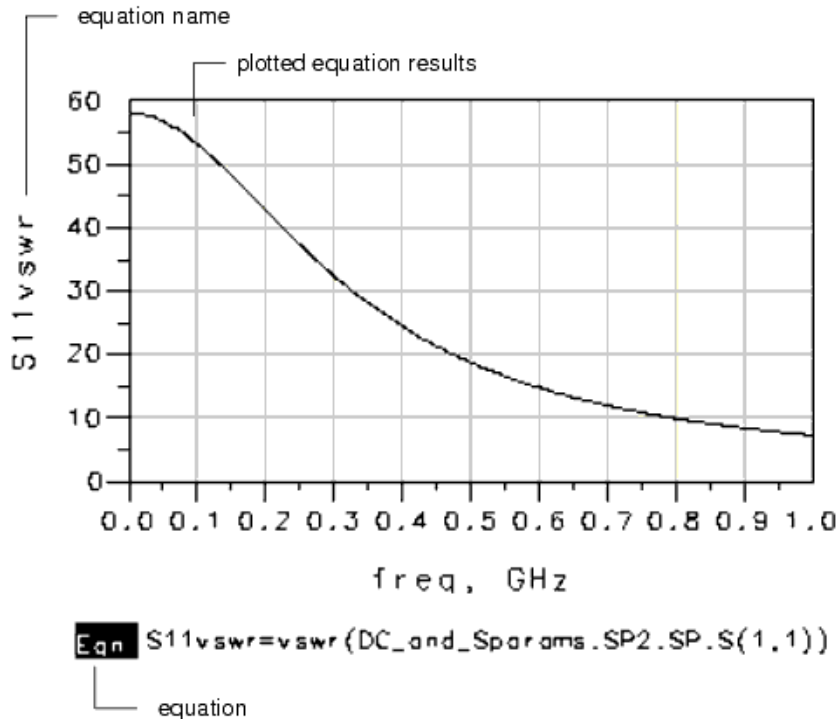

Equation results can also be displayed in text objects. For more information refer to *Embedding Equations in Text Objects*. (data)

## Working with Multidimensional Data

It is not uncommon to sweep more than one parameter in a simulation. Data from such simulations is stored as multidimensional data. If you want to perform calculations on, or display only portions of the data from such simulations, you need to use equations to select the subsets of data.

The curve tracer example is used to illustrate how to do this. The example is under the Examples directory in the MW\_Ckts subdirectory. From this subdirectory, open the workspace LNA\_wrk and then open the Curve\_Tracer schematic that is part of this workspace.

To open the data display, from the curve tracer schematic window, choose **Window > Open Data Display** and select *Curve\_Tracer.dds*.

Refer to the schematic. In this example the base current,  $IBB$ , and the collector-emitter voltage,  $VCE$  are swept in this manner:  $IBB$  is set to 5 mA, and  $VCE$  is swept from 0V to 3V in 0.1 V steps. At each 0.1 V increment,  $IC$  is calculated and stored in the dataset. When this sweep is complete,  $IBB$  is increased to 5 mA,  $VCE$  is swept from 0V to 3V, and at every 0.1 V increment  $IC$  is measured and stored in the dataset. This is repeated until  $IBB$  equals 30 mA; a final sweep of  $VCE$  is performed and the simulation is complete.

Refer to the data display. The curve tracer is the entire collection of  $IC$  data points. This data is stored in the dataset, and the structure of how data is stored is described next.

IC results. VCE and IBB are swept variables

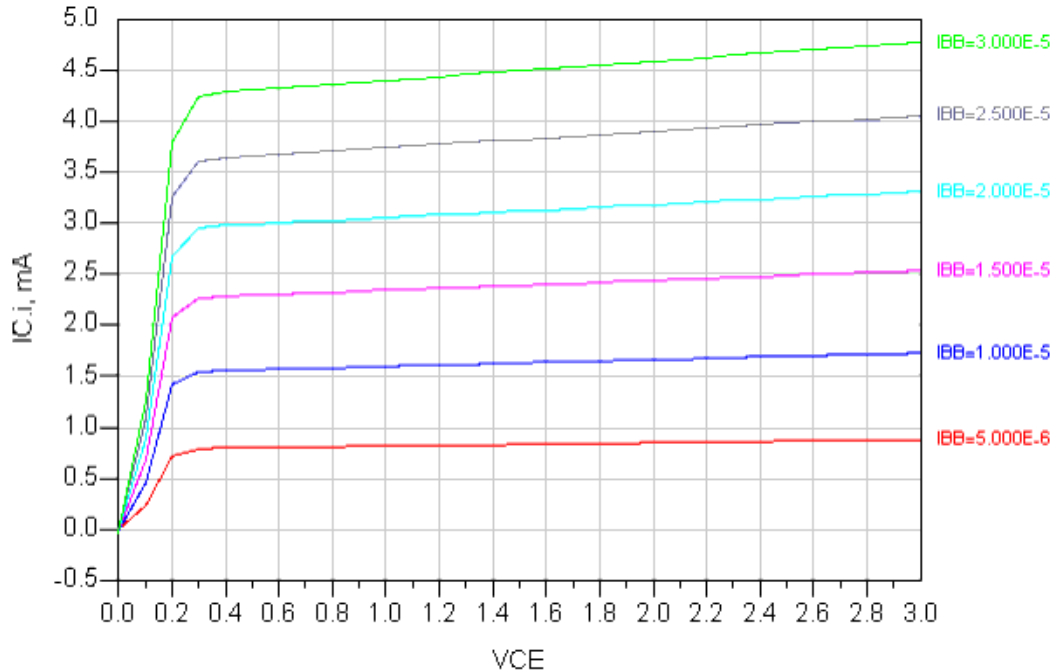

Certain measurements, such as EVM in a DSP schematic window, treat each sweep point as a separate simulation and returns a single point of data. Each point of data contains the swept variable, simulation results, and an index of zero. To display such data, create an expression such as `my_evm = E [ : : , 0 ]` to extract the zeroth index of the swept expression.

## Data Structure

Based on the simulation sweeps, there are six values for *IBB* and 31 values for *VCE*. The index for *IBB* is 0-5, the index for *VCE* is 0-30. For each of these combinations of *VCE* and *IBB*, *IC* was calculated and stored in the dataset.

		index=0	index=1	index=2	...	index=30
index=0	IBB=5uA	VCE=0V	VCE=.1V	VCE=.2V	...	VCE=3V
		IC=-4.789uA	IC=230.3uA	IC=728.6uA...		IC=882.4uA
index=1	IBB=10uA	VCE=0V	VCE=.1V	VCE=.2V	...	VCE=3V
		IC=-9.537uA	IC=467.9uA	IC=1.422mA..		IC=1.728mA
index=2	IBB=15uA	VCE=0V	VCE=.1V	VCE=.2V	...	VCE=3V
		IC=-14.25uA	IC=690.4uA	IC=2.072mA ...		IC=2.535mA
index=5	IBB=30uA	VCE=0V	VCE=.1V	VCE=.2V	...	VCE=3V
		IC=-28.21uA	IC=1.269mA	IC=3.797mA ...		IC=4.771mA

It is possible to select a single point of data or a sequence of data. The next section describes how to access portions of data using indices.

## Accessing Data

Data is accessed by index values. The equation below returns the value of  $IC$  when  $VCE = 0V$  and  $IBB = 20\text{ mA}$ .

$x = IC.i[3, 0]$  ← use square brackets

Type the equation and use a list to display your results. For information on how to enter equations, refer to [Inserting Equations](#). For information on how to display equation results, refer to [Viewing Equation Results](#).

Eqn  $x = IC.i[3, 0]$  — equation

x
-1.893E-5

— equation result in a list

For this equation, the order of the indices did not matter, but in general it does. The next section describes index order.

## Index Order

Data is retrieved by the index values. The index order is critical to returning intended data, and it is based on how the simulation is set up. In the curve tracer simulation, the Parameter Sweep item references the DC Simulation item, and the DC simulation parameter ( $VCE$ ) is swept based on the parameter-sweep parameter ( $IBB$ ). The index order is outermost to innermost, so the index for  $IBB$  precedes the index of  $VCE$ .

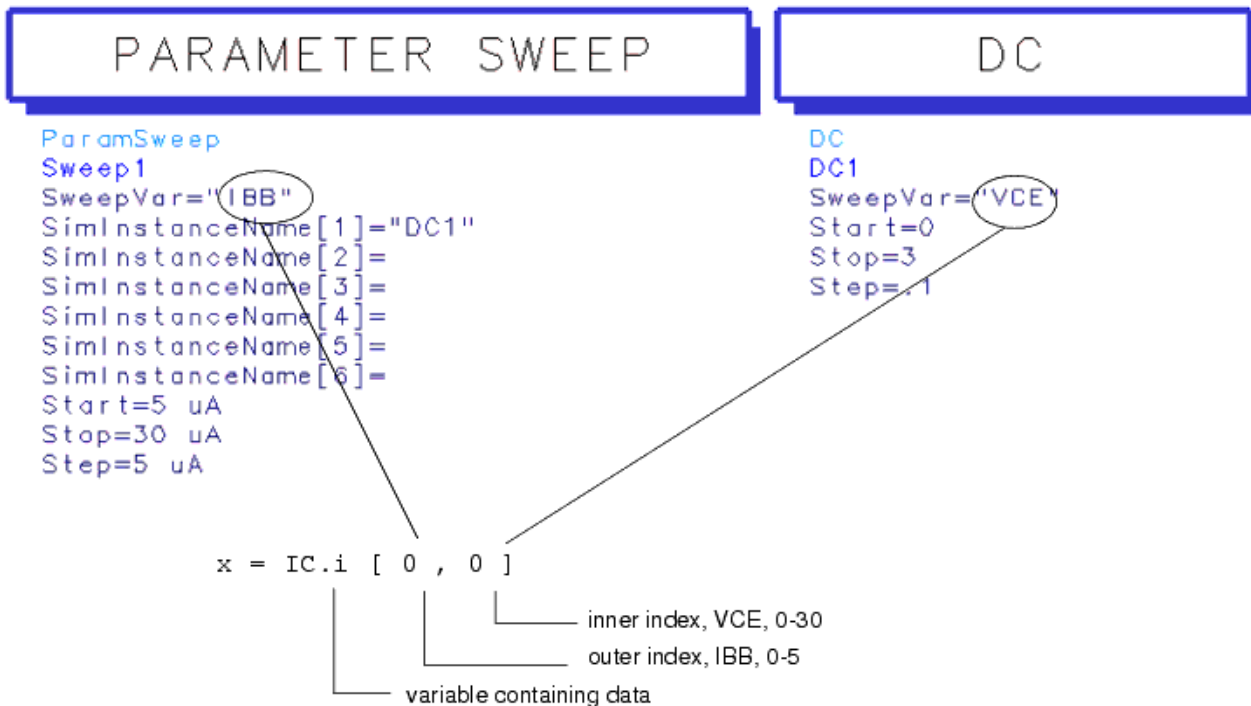

Try retrieving other data points, such as:

```

x1=IC.i[1,0]
x2=IC.i[0,1]
x3=IC.i[1,30]
    
```

View the results in lists and compare your results to the data structure illustration.

## Accessing Sequences of Data

You can access subsets of data using indices. You can either specify the range, or use wild cards. For example, to display only the trace for  $IBB = 20\text{mA}$ , type as an equation:

```
IBB20=IC.i[3,::]
```

Add *IBB20* to the curve tracer plot to view the results.

The characters `::` in the equation are the wildcard. In this equation, the wildcard substitutes for a *VCE* index value, so all values of *VCE* are used and the entire trace of data is returned.

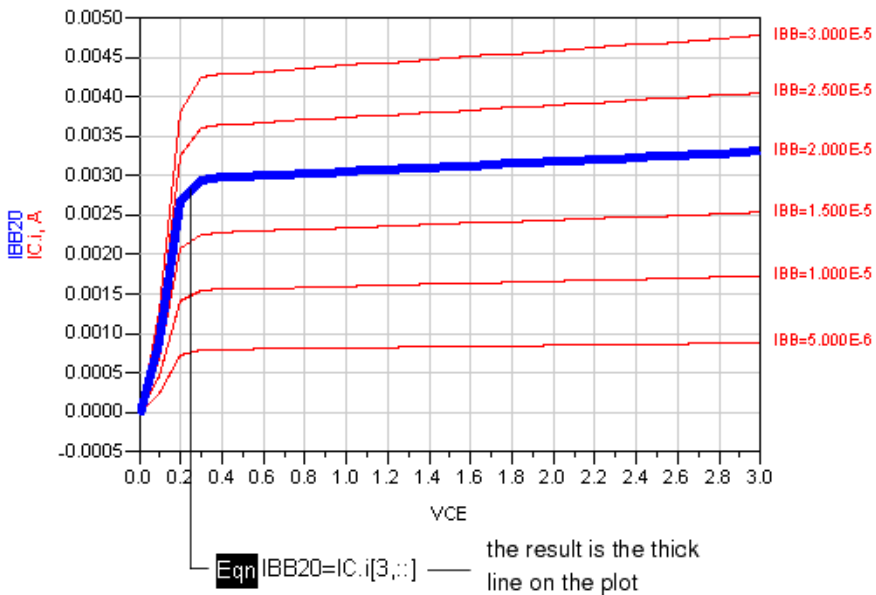

To display only a portion of the trace, use a sequence:

```
IBB20=IC.i [3, 10::1::20]
```

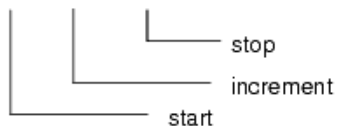

The data in the 10th through 20th elements are displayed. The default increment is 1, so this sequence could also be written as `10::20`. If you want to skip data points within the sequence, set the increment to a value larger than one.

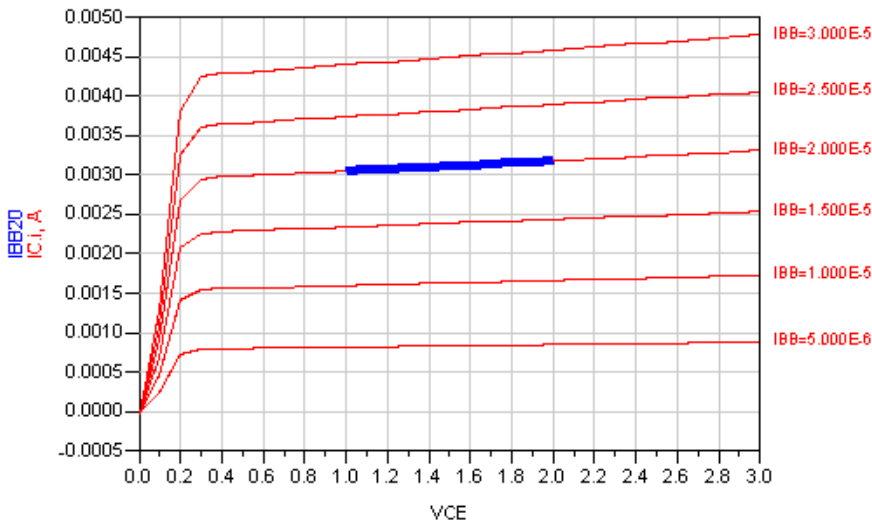

Eqn IBB20=IC.i[3,10::1::20]

**Note**  
 Try setting this trace to a Scatter trace type, then insert different increment settings in the equation to view the effects of the increment parameter.

To display a portion of several traces, use two sequences:

$$IBB20=IC.i[3::5,10::20]$$

Note the results on the curve tracer plot.

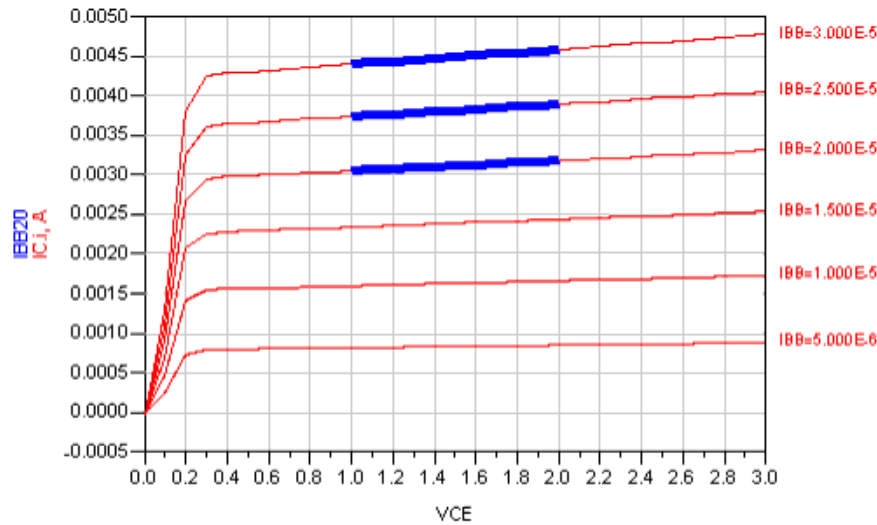

Eqn IBB20=IC.i[3::5,10::20]

### Accessing a Sweep of Data

You can return a sweep of data using a wildcard in the first position of the equation:

$$VCE5=IC.i[:,5]$$

This example returns the values of *IC* where *VCE* = 0.5V.

Do not plot this result on the existing curve tracer plot. Instead, insert a new plot and add the data to the new plot. The axes on this plot are different from the curve tracer. *VCE* is plotted along the y axis as a function of *IBB*, which is plotted along the x axis.

You can change the trace type from Linear to Scatter and see the individual data points.

You can also write the same equation as:

$$VCE5=IC.i[5]$$

The wildcard in the first position is assumed.

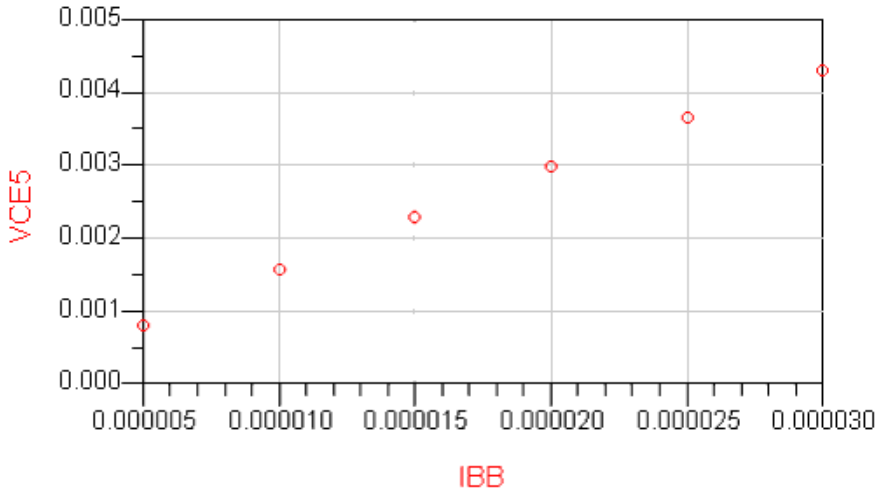

**Eqn**  $VCE5=IC.i[:,5]$

### Plotting Multidimensional Data

When you plot multidimensional data, the x-axis depends on whether the data is plotted using a single index value or using the wildcard (:) to select all index values.

The what() function returns the dimensions in the dataset entry and the number of points in each dimension. The following shows that the dimensions in BudGain1 are Component, X, and freq.

**Eqn**  $q=what(BudGain1)$

q
Dependency : [Component,X, freq]
Num. Points : [12, 11, 1 ]

The following shows multidimensional data plotted using a single index value (0) for frequency:

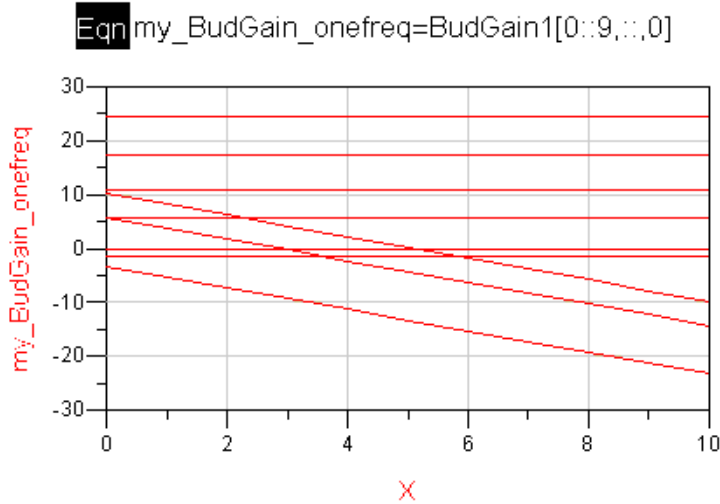

Since frequency is a single index value, the x-axis value shifts left to the next dimension, which is X in this example.

The following shows the same multidimensional data plotted using the wildcard to select all index values for frequency:

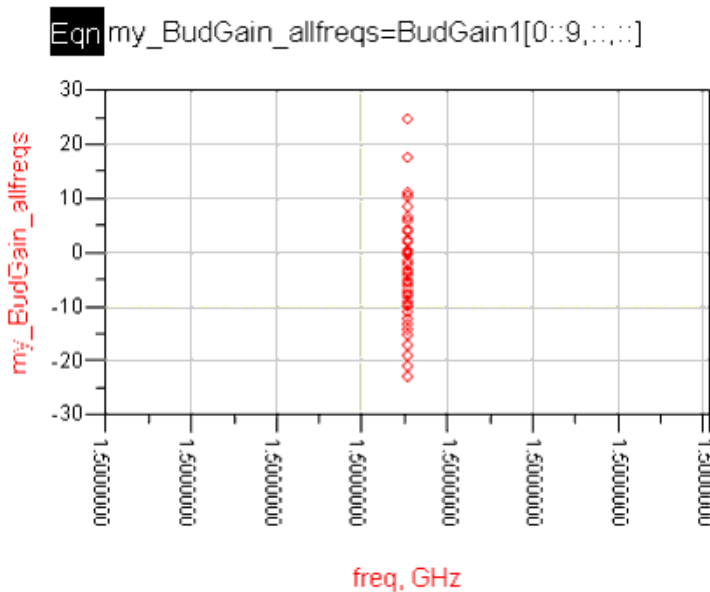

Since frequency is all index values, the x-axis value is frequency. In this example, frequency was a single value so you may have expected the same results as shown using a single index value. However, the plotting routine does not make a distinction between the case where the wildcard represents one index value or multiple index values.

## Working with Swept S-parameters

If you want to access subsets of swept S-parameters, you need to use both index notation and S-parameter notation. This section describes the various combinations and the results that are returned.

### Setting up an Example

If you want to have an example to work with, set up and perform the simulation described here.

Otherwise, skip to the next section.

This example adds a parameter sweep to the *amplifier* schematic in the SweptSparams\_wrk workspace.

1. From the Main window, click the Examples directory.
2. Select **Tutorial**.
3. Select SweptSparams\_wrk.
4. Make a copy of the SweptSparams\_wrk workspace.
5. Open the copy of **SweptSparams\_wrk**.
6. Open the schematic **amplifier**.
7. Add a swept parameter by modifying the voltage source using a Var Eqn Data item and a parameter sweep item, as shown below.

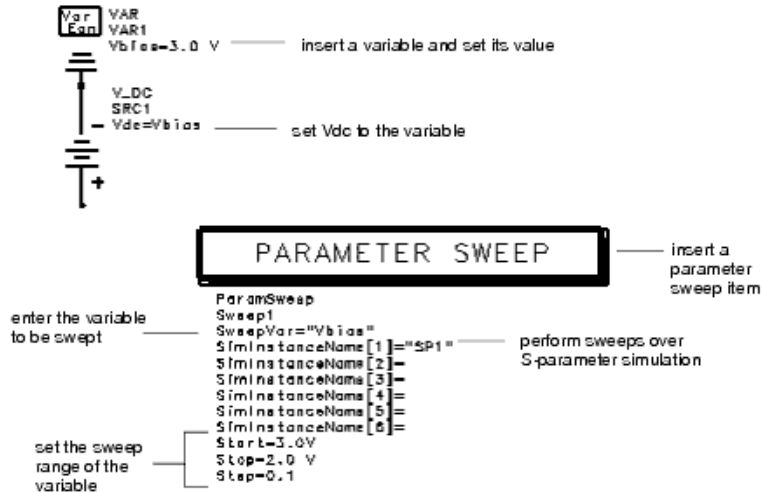

8. Rerun the simulation. The simulation will run in this manner: *Vbias* is set to 3V and an S-parameter simulation is performed at each frequency specified in the S-parameter simulation item and the S matrixes are stored in the dataset; *Vbias* is set to 3.9 V and another set of S-parameter simulations are performed and stored in the dataset; this continues until *Vbias* equals 2.0 V, when a final set of S-parameter simulations are performed and the entire simulation is complete.
9. When the simulation is complete, open a new Data Display window.
10. Set the default dataset to **amplifier**.
11. Insert a rectangular plot and add S(2,1) to the plot. The entire collection of S(2,1) data points that were calculated for each frequency point and for each value of *Vbias* is displayed.

The next section describes how the data is stored in the dataset.

## Data Structure

Based on the simulation sweeps, there are eleven values for *Vbias* and 200 values for *freq*. The index for *Vbias* is 0-10, the index for *freq* is 0-199. For each of these combinations of *Vbias* and *freq*, an S matrix was calculated and stored in the dataset.



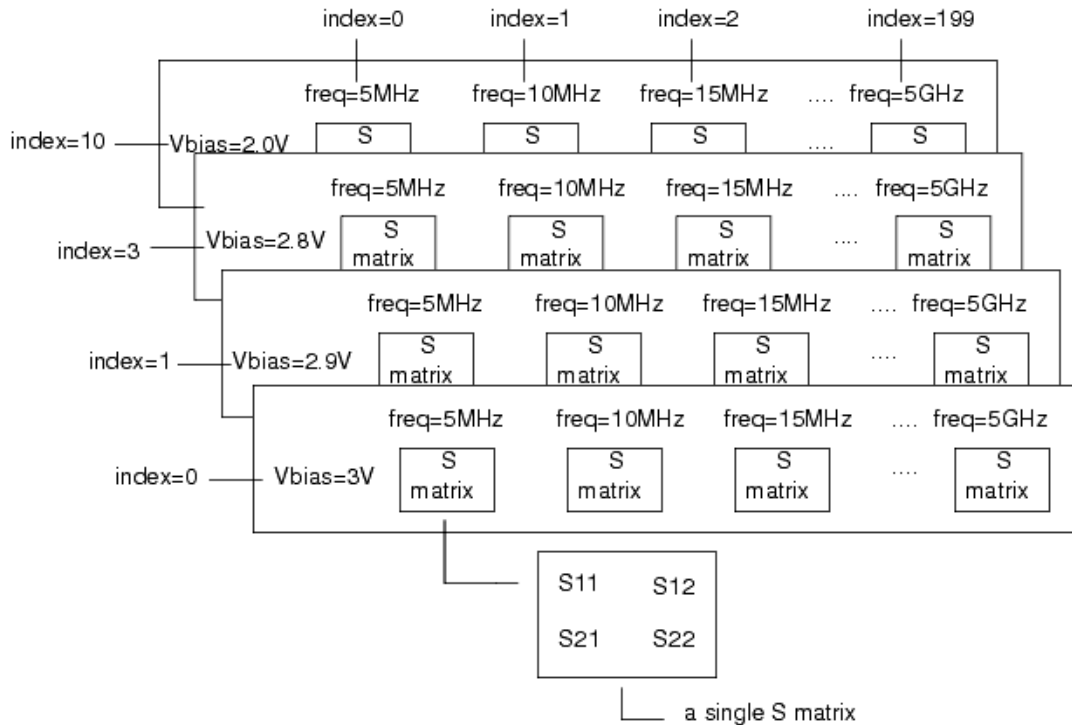

Index order is the same as described in [Index Order](#). That is, the outermost index is first, innermost is last. In the example above, the first position is the index of *Vbias*, the second is for *freq*.

## Accessing Data

You can access S-parameters using indices. The equation below returns  $S_{21}$  calculated for  $Vbias = 2.9$  V and  $freq = 5$  MHz:

$$myS21=S21[1,0]$$

Type the equation and use a list to display your results. For information on how to enter equations, refer to [Inserting Equations](#). For information on how to display equation results, refer to [Viewing Equation Results](#).

myS21	
9.604E-5 / -109.798	equation result in a list

The equation below returns  $S_{21}$  at all frequencies for a single value of  $Vbias$  ( $Vbias = 2V$ ):

$$S21at2V=S21[10,::]$$

Add this result to a plot. The wildcard `::` is used to substitute for a *freq* index, so all values of *freq* are returned, enabling you to display an entire trace of  $S_{21}$  results.

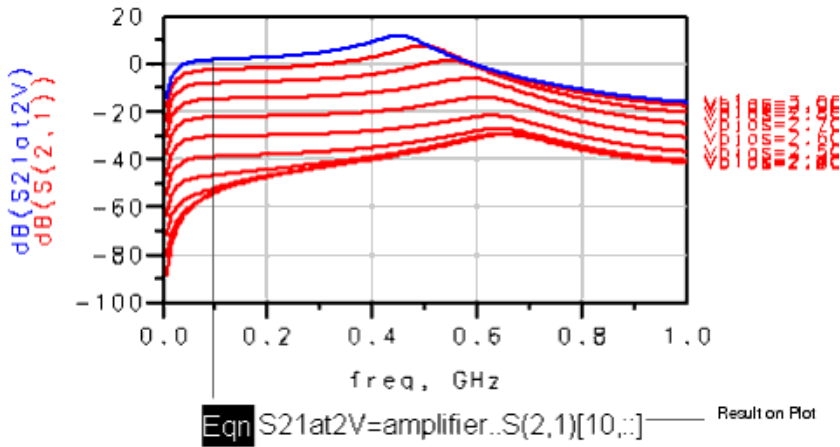

To display only a portion of the trace, use a sequence:

```
S21at2V=S21[10,80::1::199]
```

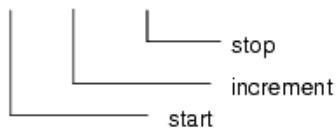

The data in the 50th through 199th elements are displayed. The default increment is 1, and the sequence could be written as 50::199. If you want to skip data points within the sequence, set the increment to a value larger than one.

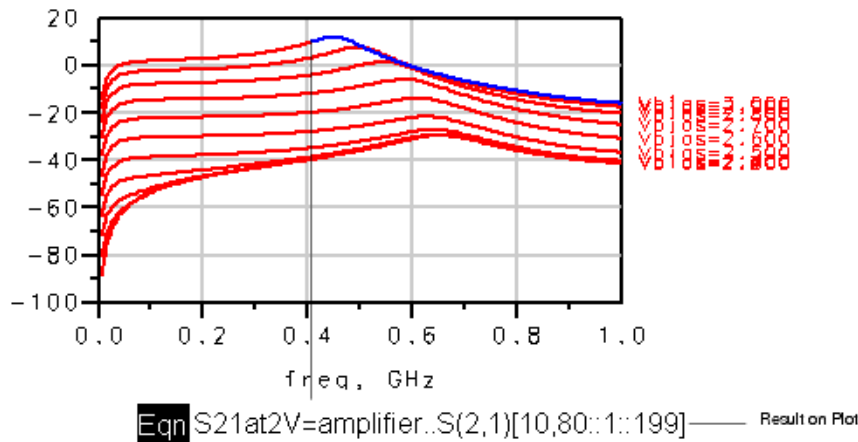

**Hint**  
 Try setting this trace to a Scatter trace type, then insert different increment settings, for example replace 1 with 20, to view the effects of the increment parameter.

To display a portion of several traces, use two sequences:

```
S21block=S21[2::10,90::140]
```

Add this to the plot and note the results.

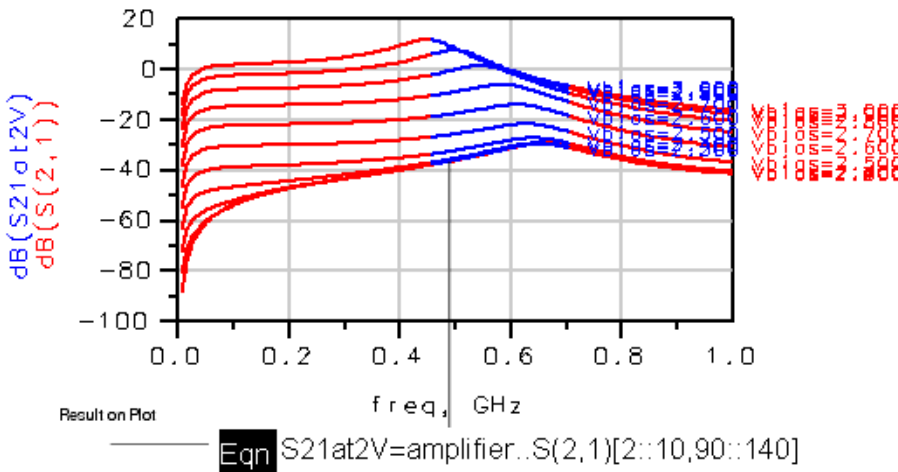

### Accessing a Sweep of Data

You can return a sweep of data using a wildcard in the first position of the equation:

```
column=S21[:,80]
```

This example returns  $S_{21}$  for every value of  $V_{bias}$  at the frequency with index 80.

Do not plot this result on the existing curve tracer plot. Instead, insert a new plot and add the data to the new plot. The axes on this plot are different from the curve tracer.  $S_{21}$  is plotted along the y axis as a function of  $V_{bias}$ , which is plotted along the x axis.

You can change the trace type from Linear to Scatter and see the individual data points.

You can also write the same equation as:

```
column=S[80]
```

The wildcard in the first position is assumed.

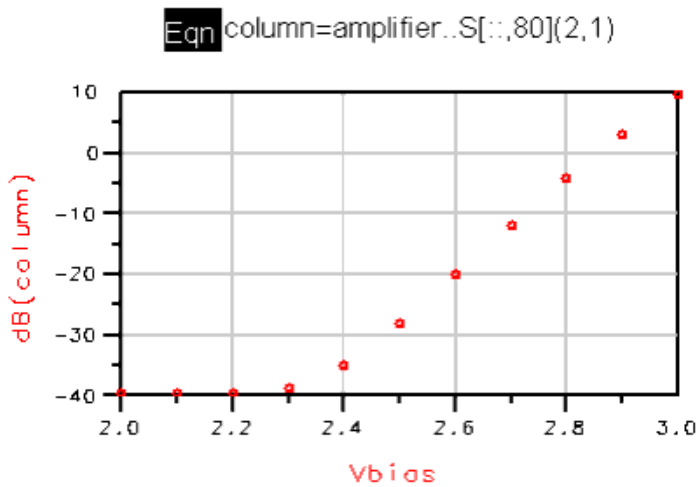

### Working with an S Matrix

S-parameters are stored in an S matrix. In general, you will probably want to work with a specific S-parameter and not the entire matrix. You can, however, access an entire matrix. If you do not specify an S-parameter, an equation using S returns the entire S matrix:

```
myMatrix=S[1,0]
```

**Eqn** myMatrix=S[1,0]

myMatrix		
myMatrix(1,1)	myMatrix(1,2)	myMatrix(2,1)
0.885 - j0.002	-1.504E-5 + j2.606E-6	-1.547E-5 + j9.906E-8

**Note**

If ellipsis points appear in the list of data, enlarge the list by selecting the list and dragging a handle horizontally until all values are displayed correctly.

You can also use indices in this way without specifying an S-parameter and return the S matrix at each point:

```
manyMatrices=S[2::5, 80::90]
```

Use a list to display your results. Use the scroll buttons to browse the entire list of data. As you can see, a large amount of data is returned.

## Viewing Variable Information

Use the *what* function to view information about a variable, including:

- Independent variables
- Number of data points
- Matrix size
- Data type, such as real or complex

If the variable contains a single number or a one-dimensional sequence of numbers (like a row or column) it is termed *Scalar*. If the data is two dimensional, it is termed a *Matrix* and the size of the matrix is given. Examples of two variables from the swept S-parameter example, *Vbias* and the S matrix, *S*, are shown below. For details about these variables, refer to [Setting up an Example](#).

what{Vbias}	
Dependency	: [Vbias]
Num. Points	: [11]
Matrix Size	: scalar
Type	: Real

what{S}	
Dependency	: [Vbias, freq]
Num. Points	: [11, 200]
Matrix Size	: {2,2}
Type	: Complex

## Finding an Index

The amount of data in this simulation is two dimensional and relatively small, and it is not difficult to determine the swept parameter values that correspond to indices. For more complex problems, you

can use the *find\_index()* function. The *find\_index()* function returns the index that corresponds to a data value. For example, in the *Curve\_Tracer* example, *VCE* is a scalar that contains 61 points of data. The equation below returns the index when *VCE* is 3 V:

```
VCEIndex=find_index(VCE[2, :], 3)
```

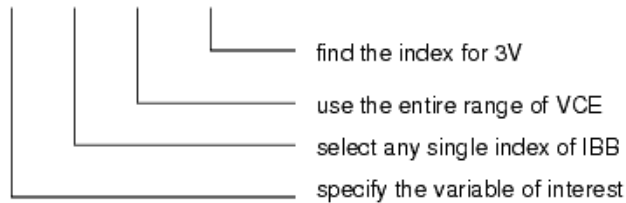

The *find\_index()* function works only on scalar data. *VCE* is specified using indices in order to present it in scalar format.

## Using Markers in Equations

You can add marker labels to equations and perform operations on marker data. The operation is performed on the dependent marker data.

To add a marker to an equation:

1. Click the **Equation** button on the palette or choose **Insert > Equation**.
2. Position the pointer on the display area and click the mouse.
3. The Enter Equation dialog box appears. Type the equation.
4. At the point where you want to add the marker, choose **Equations** \_\_\_ from the Datasets and Equations \_\_\_ list.
5. Select the marker label and click **Insert**.
6. Complete the equation, then click **OK**.

You can treat markers like any other variable in an equation.

### Note

If you change the marker label (which is accomplished by selecting the marker and choosing **Edit > Item Options**), you must edit your equations by deleting the old marker label and entering the new marker label.

## Using Independent Marker Data

You may want to retrieve the independent data in a marker. You can do this using the *indep* function. For example:

```
myequation=indep(m1)
```

where *m1* is the marker label. You can also nest this within another function.

Markers on polar plots and Smith charts return data in complex format. You may want to work with only the imaginary portion of the number, which you can retrieve using the *imag* function. The illustration shown next shows a Smith chart, the marker applied to a trace, the equation used to isolate the imaginary component, and a list to verify the equation is correct.

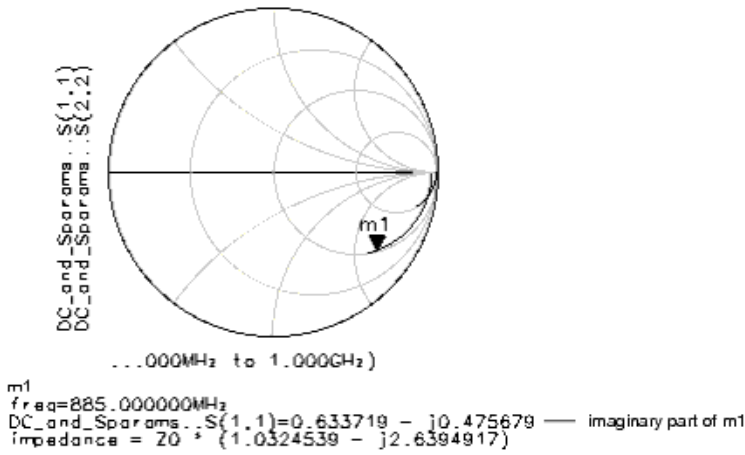

**Eqn** m1 imag = imag(m1) ———— imaginary part of m1 returned

freq	m1 imag
885.000M	-0.476

equation is correct

## Generating a Histogram after Monte-Carlo Analysis

The example in this section demonstrates a simple histogram using data from the Tutorial/yldex1\_wrk example. The example simulates the frequency response of an impedance transformer, with component values varied during a yield analysis. For more information on generating a histogram, refer to *Using Statistical Design* (optstat).

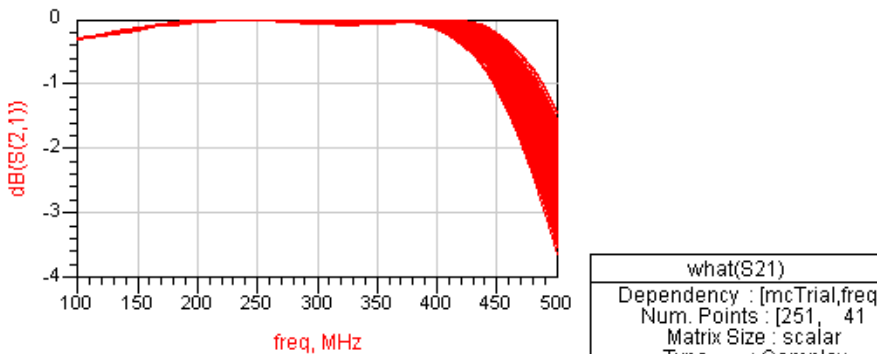

**Eqn** freq\_index=find\_index(freq[0,:],500MHz)

**Eqn** NumBins=20

**Eqn** Hist\_S21\_at\_1Freq=histogram(dB(S21[:,freq\_index]),NumBins)

Histogram showing distribution of insertion loss at one particular frequency, specified in "freq\_index" equation.

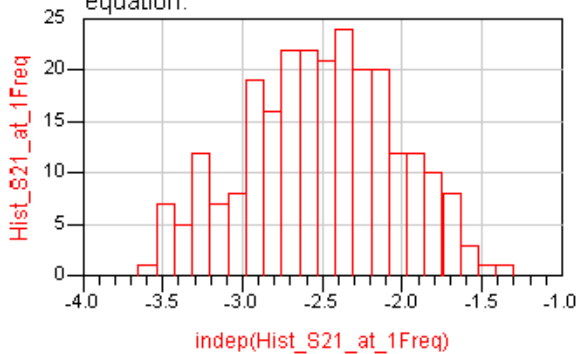

### Simple Histogram using data from the Tutorial/yldex1\_wrk Example

- The first plot in [Simple Histogram using data from the Tutorial/yldex1\\_wrk Example](#) above shows all of the dB(S21) curves.
- The second plot shows the distribution of dB(S21) at one particular frequency, specified by the "freq\_index" equation.
- The S21[:,freq\_index] syntax selects the S21 values for all Monte Carlo iterations at the "freq\_index" frequency.
- The NumBins variable just sets the number of histogram bins.

## Using Predefined Equations

Data Display has a set of predefined equations that you can use to display and document current data properties such as default dataset name and path.

The following table lists the predefined equations available:

Predefined Equation Name	Description
Default_Dataset_Name	The current default dataset name. This name does not include the ".ds" extension
Default_Dataset_Path	The full path to the directory that contains the default dataset
Default_Dataset_Modified_Time	The time the default dataset file was last modified
Default_Dataset_Modified_Date	The date the default dataset file was last modified
Default_Dataset_Size	The size in bytes of the default dataset
DDS_File_Name	The current DDS file name without the ".dds" extension
DDS_File_Path	The path to the directory that contains the current DDS file
DDS_File_Modified_Time	The last time the DDS file was modified
DDS_File_Modified_Date	The last date the DDS file was modified
DDS_File_Size	The size in bytes of the DDS file

You can display dataset information in two ways, using either a text object or a list.

To display dataset information in a text object refer to *Embedding Dataset Properties in Text Objects*. (data)

To display dataset information in a list...

1. Select **List** from the palette or choose **Insert > Plot**, then click the mouse on the page to place the plot and display the Plot Traces & Attributes dialog box.
2. Select **List** in the Plot Type tab.
3. From the Datasets and Equations dropdown menu select **Predefined Equations**.
4. Use the dialog box to select and add data properties to the display.

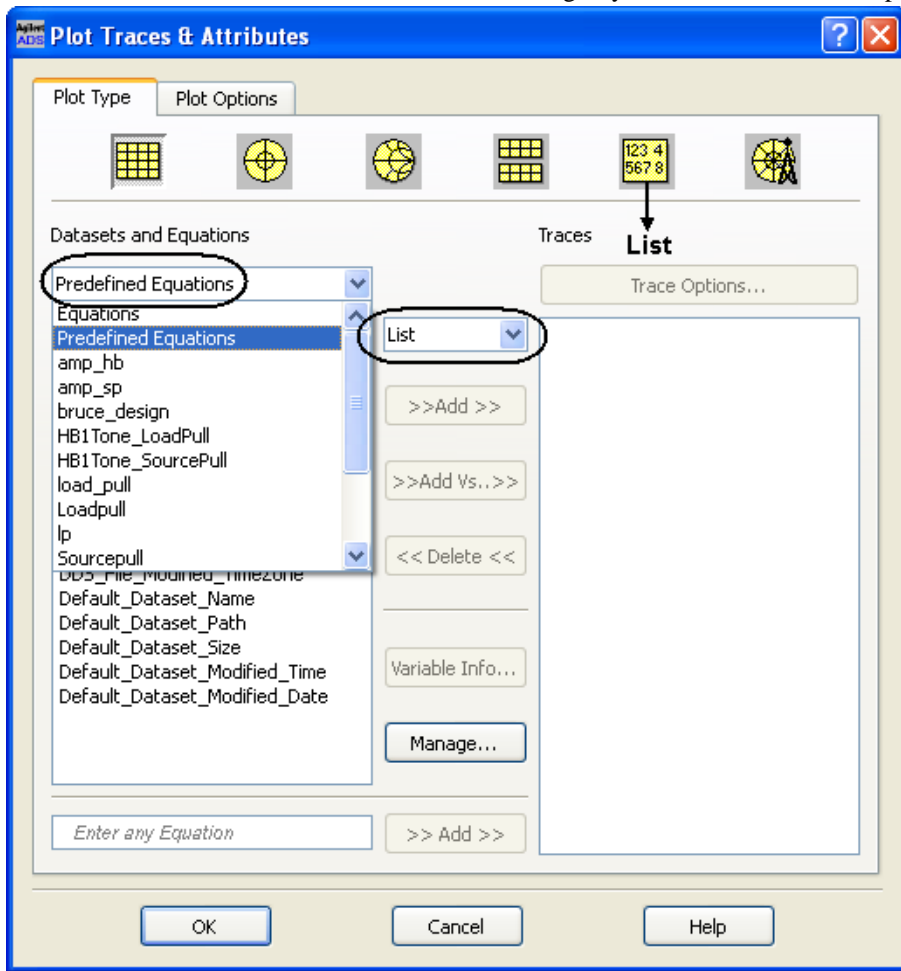



# Sliders

The slider plot simplifies the process of accessing individual sweeps of swept data by automatically generating an equation that contains the data index for the desired sweep.

The format of the generated equation is: <MarkerName>\_<SweepName>\_index

Where

- *MarkerName* is the name of the marker that is automatically added to the slider during plots creation.
- *SweepName* is the name of the swept data of interest.

This equation can be used to select a specific sweep of swept data.

## Inserting Slider

Follow the steps below to insert a slider plot:

1. From the DDS window, choose **Insert > Slider**.

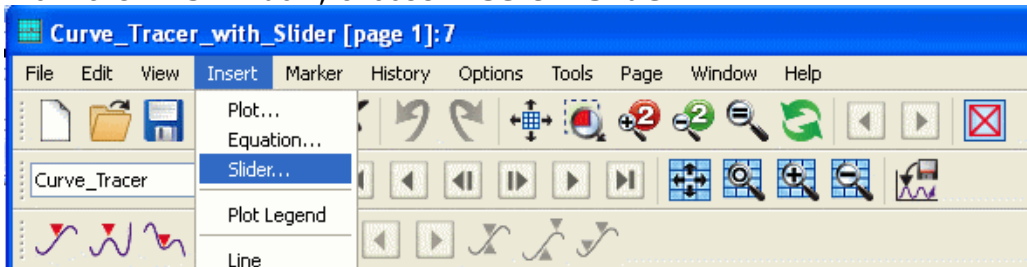

2. Position the pointer on the display area. A rectangle image is attached to the pointer which indicates the position and size of the plot.
3. One you place the Slider anywhere in display are, the Slider Plot Trace & Attributes dialog box appears.
4. Select the trace that contains the swept data that you want the slider to operate on and click **>>Add >>** button to add it to the **Trace** list.
5. Select the data to sweep with the slider.

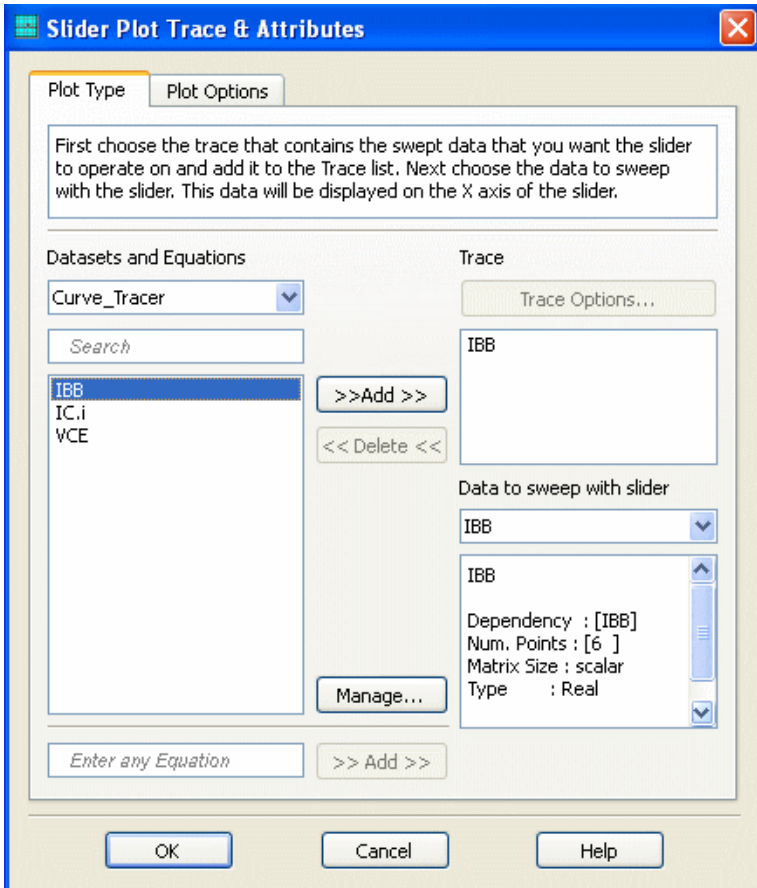

6. Select the **Plot Options** tab to set up the plot. Enter the title and define scaling data accordingly. For more details on how to change plot options, see *Editing Plots (data)*.
7. Click **OK** to insert the slider plot and to create the "m1\_IBB\_index" equation.

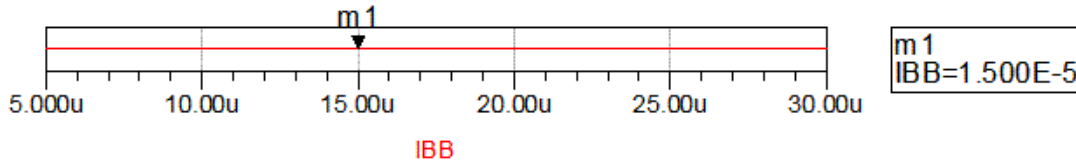

Once the slider has been created you can use the index equation to select a specific sweep of the swept data. In the above example index equation is used to create a trace that shows an individual sweep of the sweep curve trace data. The data of interest, in this case IC.i, contains one sweep of IBB and the inner most data of VCE. The slider equation has been applied to the IBB sweep of the IC.i data. The equation to plot this data looks like this "IC.i[m1\_IBB\_index,::]". As you move the marker "m1" on the slider the blue trace will move up and down along the plot as the slider index equation is updated with each marker move.

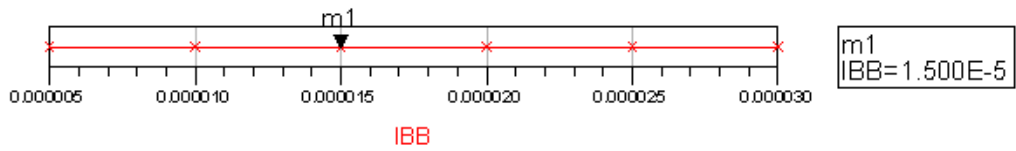
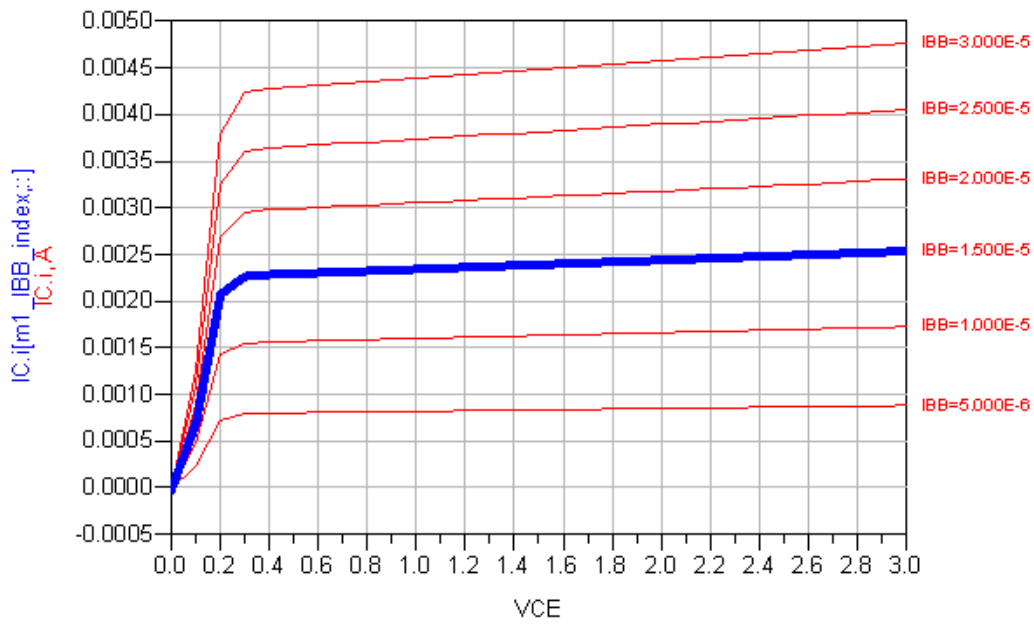

# Annotating the Data Display

Designs can be better documented by making annotations on the display. The Data Display includes drawing tools that enable you to annotate the display by inserting text and drawing objects.

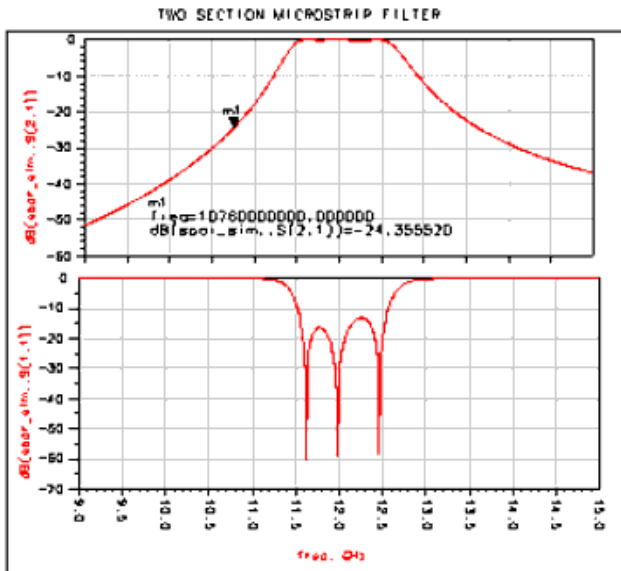

Filter Bandwidth Calculation

Run N<sub>dB</sub>=3 ← Select NdB bandwidth!

bandwidth
1.200G

```

Run x=db[S21]
Run SearchValue=max(x)-NdB
Run LowerFreqIndex=find_index(x,SearchValue)
Run LowerFreqPoint=freq[LowerFreqIndex]
Run one_above_limit=if ( x > SearchValue ) then 1 else 0
Run NumberPoints=sum(one_above_limit)
Run UpperFreqIndex=LowerFreqIndex+NumberPoints
Run UpperFreqPoint=freq[UpperFreqIndex]
Run bandwidth=UpperFreqPoint-LowerFreqPoint
    
```

LowerFreqPoint
11.41G

UpperFreqPoint
12.70G

## Inserting Text

### Adding Text

To add text to the Data Display:

1. Choose **Insert > Text** or select **Text** from the palette.

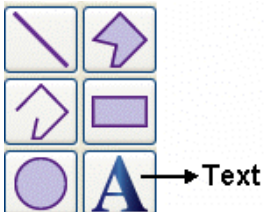

- Click the mouse on the display page to place the text. The insertion point is marked by a red cursor.
- Type the text.
- When you are finished, click the **End Command** button on the toolbar or choose **Edit > End Command**.

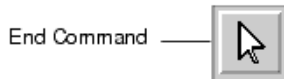

## Embedding Equations in Text Objects

You can display equation results as well as equation names in text objects.

Any named equation can be embedded in a text object by preceding its name with the "@" character, for example "@freq". Use either the onscreen editor or the Enter Text dialog box to embed or edit equations in texts.

To embed equations in the text using the onscreen editor...

- Choose **Insert > Text** or select **Text** from the palette.
- Single-click the mouse on the display page.
- Type the text and place the "@" character before any equation name.
- When you are finished, click the **End Command** button on the toolbar or choose **Edit > End Command**.

To embed equation results in the text using the Enter Text dialog box...

- Choose **Insert > Text** or select **Text** from the palette, then double click the mouse on the page to place the text and display the Enter Text dialog box.
- Select the **Select Data and View Warnings/Errors** checkbox to display the dataset browser.
- Insert an equation in the text by double-clicking it or by selecting its name from the dataset browser and clicking the **Insert** button. The equation name will be added to the text field preceded by the "@" symbol. Click **OK**.

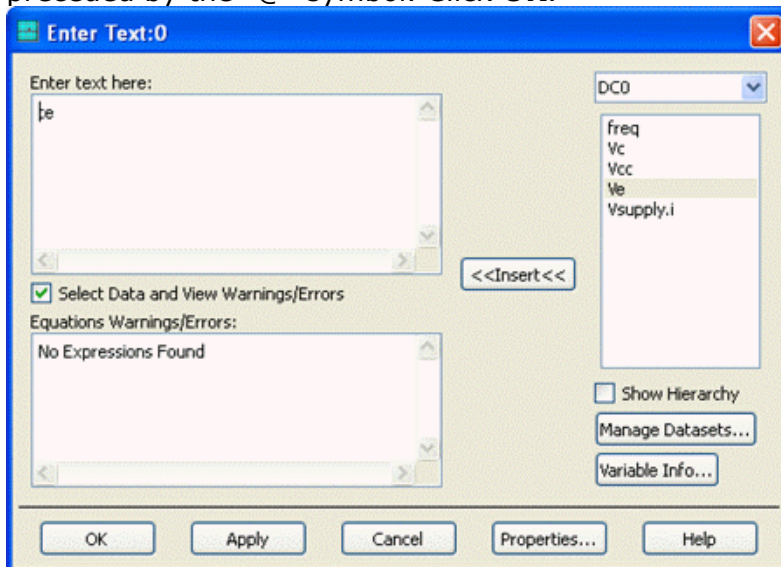

When you deselect the text object, the equation results are automatically evaluated and displayed in the text. Up to three data items, separated by commas, are displayed for each equation, followed by "..." if more data items are available.

Frequency: 1000000000.000, 1100000000.000, 1200000000.000, ...

To re-activate the onscreen editor, single-click the text. The text is highlighted and displayed in its original form, showing the equation name.

**Frequency:@freq**

To display the equation name and not the calculated result, add a backslash before the "@" symbol in the text editor. For example: "@freq".

If an error occurs, or the equation is not found, the equation name is displayed in the text instead of the equation result.

**Note**  
Embedded equations may generate errors and warnings, which appear in the Equations Warnings/Errors area in the Enter Text dialog box.

## Embedding DDS File and Dataset Properties in Text Objects

Data Display has a set of predefined equations containing current DDS file and dataset information such as default dataset name and path. These equations enable you to embed dataset information in text objects, simplifying documentation.

The following table contains the list of predefined equations available:

Predefined Equation Name	Description
Default_Dataset_Name	The current default dataset name. This name does not include the ".ds" extension
Default_Dataset_Path	The full path to the directory that contains the default dataset
Default_Dataset_Modified_Time	The time the default dataset file was last modified
Default_Dataset_Modified_Date	The date the default dataset file was last modified
Default_Dataset_Size	The size in bytes of the default dataset
DDS_File_Name	The current DDS file name without the ".dds" extension
DDS_File_Path	The path to the directory that contains the current DDS file
DDS_File_Modified_Time	The last time the DDS file was modified
DDS_File_Modified_Date	The last date the DDS file was modified
DDS_File_Size	The size in bytes of the DDS file

You can embed dataset information in the same way you embed other equations in text objects:

1. Choose **Insert > Text** or select **Text** from the palette, then double click the mouse on the page to place the text and display the Enter Text dialog box.
2. Select the **Select Data and View Warnings/Errors** checkbox to display the dataset browser.
3. In the dataset browser dropdown menu select **Predefined Equations**.
4. Insert the desired equation in the text by double-clicking it or by selecting its name and clicking the **Insert** button. The equation name will be added to the text field preceded by the "@" symbol. Click **OK**.

## Editing Text

The text, fill, and outline of a text box can be easily changed by using the Enter Text dialog box. Any changes made from this dialog box will only affect the currently selected text box. To change the

options for all subsequent text entries, refer to [Setting Text Preferences](#).

To edit text:

1. Double-click on the text or select the text and choose **Edit > Item Options**.
2. The Enter Text dialog box appears.
3. Change the text as desired.
4. To change the text format, click the **Properties** button.
5. To change the font properties:
  - Select a font from the Font Type list.
  - Select a font size from the Font Size list.
  - Click the **Text Color** bar, select a new color, then click **OK**.
6. The text is enclosed in a text frame. To display the outline of this frame, enable **Draw Outline**.  
To edit the outline:
  - Select a line pattern from the Type list.
  - Select a line thickness either by using the scroll bar or entering a value into the Points field.
  - Click the **Color** bar, select a new color, then click **OK**.
7. To fill the background of the frame, enable **Use Fill Pattern**. To edit the fill:
  - Click the **Color** bar, select a new color, then click **OK**.
  - Click the **Pattern** bar, select a pattern, then click **OK**.
8. Click **OK** to close the Edit Text Properties dialog box.
9. Click **OK** to close the Enter Text dialog box and accept the changes.

## Deleting Text

To remove a text frame, do the following:

1. To delete a single text frame, single-click on the frame. For multiple frames, hold the **Shift** key down and single-click on each frame of interest.
2. Press the **Delete** key or choose **Edit > Delete**.

## Setting Text Preferences

Any changes made to the preferences will only affect subsequently created text. To modify existing text, make the change using the Enter Text dialog box.

To save and reuse preference settings, you can create a preferences file that can be read by the data display. For more information on how to create and use such a file, refer to *Setting Data Display Preferences (data)*.

To set preferences:

1. Choose **Options > Preferences**.
2. The Preference dialog box appears. Click the **Text** tab.
3. Set the text preferences by doing the following:
  - Select a font from the Font Type list.
  - Select a font size from the Font Size list.
  - Click the **Text Color** bar, select a new text color, then click **OK**.
4. The appearance of text box outlines is set by using these selections:
  - Enable **Draw Outline**.
  - Select an outline pattern from the Type list.
  - Select the outline thickness either by using the Thickness scroll bar or entering a value into

the Points field.

- Click the **Color** bar, select a new color, then click **OK**.
5. Text box fill preferences are set as follows:
- Enable **Use Fill Pattern**.
  - Click the **Color** bar, select a new fill color, then click **OK**.
  - Click the **Pattern** bar, select a fill Pattern, then click **OK**.
6. Click **OK** to close the Preference dialog box and accept the changes.

## Inserting Objects

The commands used to add graphical objects to your display are found on the Insert menu as well as on the palette.

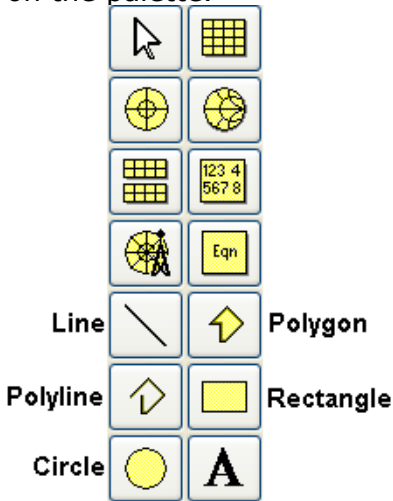

To insert an object, do the following:

1. Click the button on the palette that corresponds to the desired shape (Circle, Rectangle, etc.) or choose the shape from the Insert menu.
2. Position the pointer on the display page and click the mouse.
  - For lines, move the pointer until the line is the desired length, then click the mouse.
  - For rectangles and circles, move the pointer until the object is the desired size, then click the mouse.
  - For polylines and polygons, continue adding segments by positioning the pointer and clicking the mouse. To complete a polyline, double-click the mouse. For a polygon, draw the second to last segment and then double-click the mouse. The last segment is added to make a closed region.

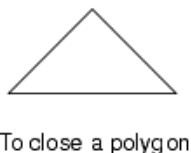
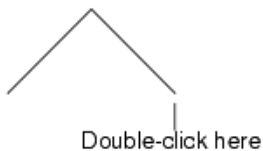

3. The object drawing mode remains active, allowing you to place other objects of the same type by moving the pointer and clicking the mouse.
4. If you are finished, click the **End Command** button in the toolbar or choose **Edit > End Command**.

## Editing Objects



You can edit object properties such as line width, line thickness, and color. For 2-D objects, you can fill the area with a pattern and color.

You can also edit objects by moving them, changing their size, or by using delete, cut, copy, and paste commands. For more information on these functions, refer to *Data Display Basics* (data).

Any changes that you make will only affect the currently selected object. To change properties for all objects added subsequently, refer to [Setting Object Preferences](#).

Objects are edited using the following steps:

1. Double-click on the object or select the object and choose **Edit > Item Options**.
2. The edit dialog box appears.
3. Lines and object outlines are edited using these selections:
  - Select a line pattern from the Type list.
  - Select the line or outline thickness either by using the Thickness scroll bar or by entering a value into the Points field.
  - Click the **Color** bar, select a new color, then click **OK**.
4. An object's fill can be changed using these selections:
  - Enable **Use Fill Pattern**.
  - Click the **Color** bar, select a new fill color, then click **OK**.
  - Click the **Pattern** bar, select a fill Pattern, then click **OK**.
5. Click **OK** to close the dialog box and accept the changes.

## Deleting Objects

To remove an object, do the following:

1. To delete a single object, single-click on the object. For multiple objects, hold the **Shift** key down and single-click on each object of interest.
2. Press the **Delete** key or choose **Edit > Delete**.

## Setting Object Preferences

Object preferences determine how new graphical objects will appear when they are inserted onto a display area.

Object preferences affect all objects created after the changes were made and saved. To change the properties for an existing object, refer to [Editing Objects](#).

To save and reuse preference settings, you can create a preferences file that can be read by the data display, which can facilitate setting preferences. For more information on how to create and use such a file, refer to *Setting Data Display Preferences* (data).

### To set "Shapes" preferences:

1. Choose **Options > Preferences**.
2. The Preference dialog box appears. Select the **Shapes** tab. It is used to set the values for the various shapes that DDS supports.
3. There are sub-tabs for each type of object. Move through the tabs and define your preferences.

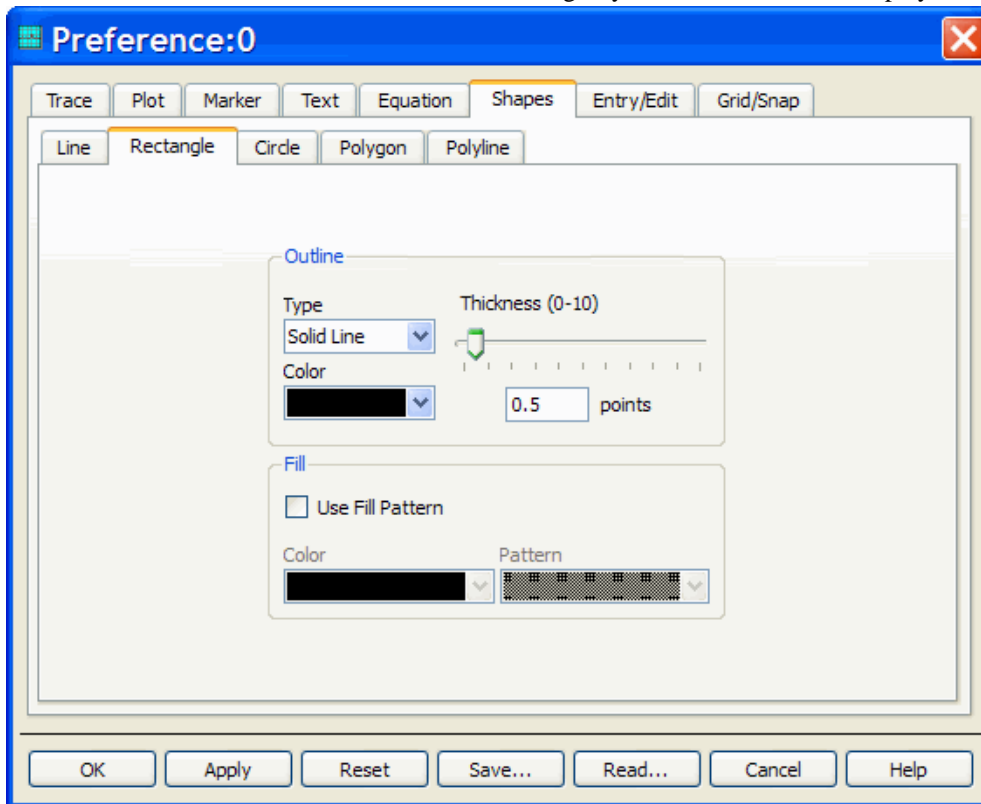

4. Lines and object outlines preferences are set using these selections:
  - Select a line pattern from the Type list.
  - Select the line or outline thickness either by using the scroll bar or entering a value into the Points field.
  - Click the **Color** bar, select a new color, then click **OK**.
5. An object's fill preferences can be set by using these selections:
  - Enable **Use Fill Pattern**.
  - Click the **Color** bar, select a new fill color, then click **OK**.
  - Click the **Pattern** bar, select a fill Pattern, then click **OK**.
6. Click **OK** to close the Preference dialog box and accept the changes.

#### To set "Entry/Edit" preferences:

1. Choose **Options > Preferences**
2. Choose the **Entry/Edit** tab from the Preferences dialog box.
3. Data and Time format are used when DDS prints a date/time entry.
4. Set the Date and Time format of your choice
5. Drag and Move defines how many screen pixels you have to move the mouse before the drag starts a move command. If you don't move the mouse this many pixels, it's considered a mouse click instead of a mouse drag.
6. The drag amount can be given only in "screen pixels"
7. Click **OK** to close the dialog box and accept the changes.

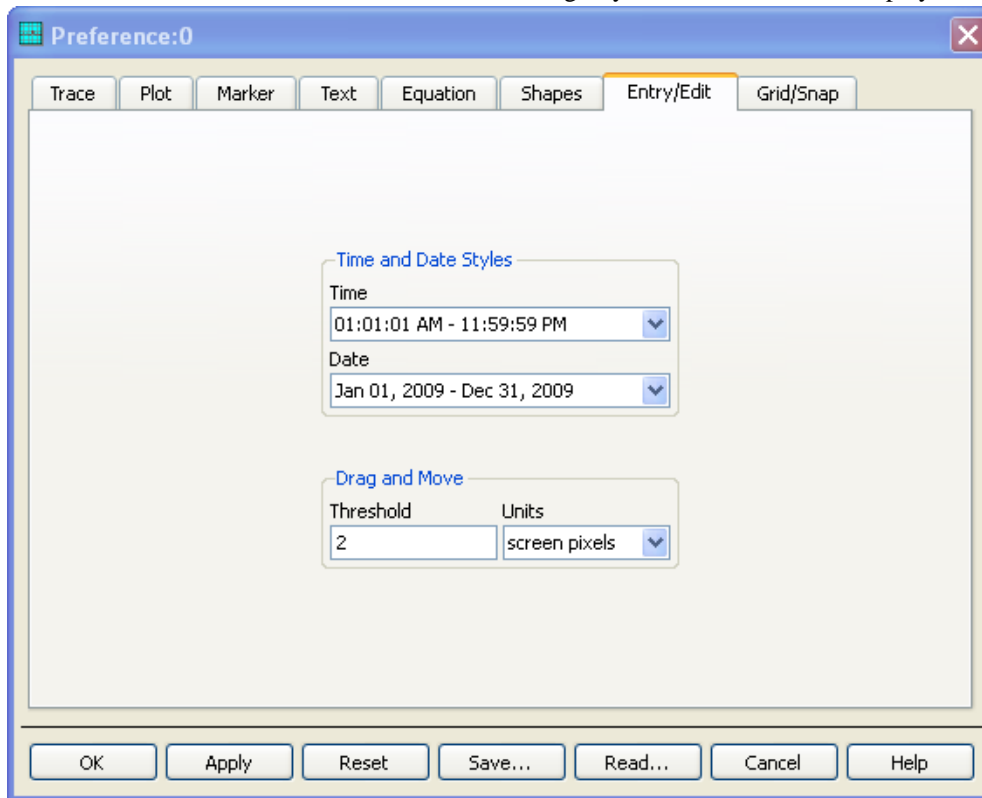

## Setting Grid/Snap Preferences

In the **Options** menu of the Data Display window, select **Preferences**. In the **Preferences** window, select the **Grid/Snap** tab, which is illustrated below.

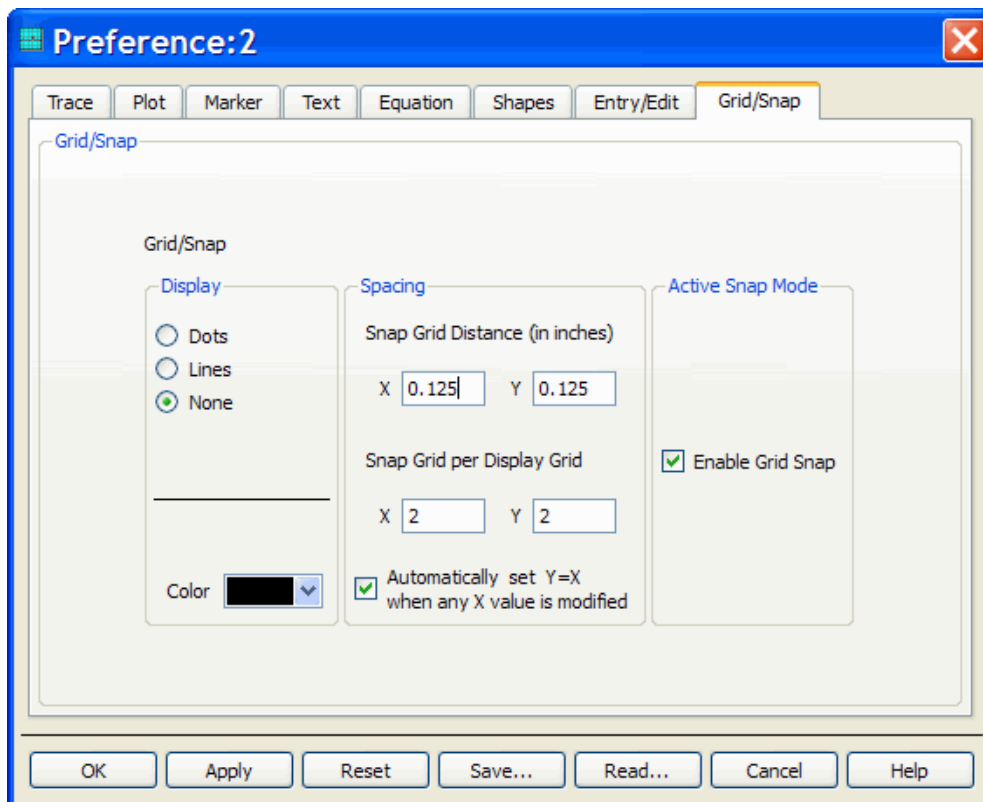

## Display

Under **Display** on the **Grid/Snap** tab, select **Dots**, **Lines**, or **None**. (**None** is selected by default; in this case, the grid will not be visible on the Data Display window, but can still be used for aligning objects.)

Use the **Color** selection tool to choose a color for the displayed grid.

In general it is best to use dark colors for dots and pale colors for lines. As the dot color and line color are independent, it is best to make the color selection *after* making the choice of dots or lines.

## Spacing

### Note

Under **Spacing** on the **Grid/Snap** tab, values entered for the X axis are also applied to the Y axis if the box labeled "Automatically set Y=X when any X value is modified" is checked (as it is by default). Even if the box is checked, Y values can still be set independently.

Select X and Y values for **Snap Grid Distance (in inches)**. This determines how far apart on the screen the displayed dots or lines will appear. The default distance for both X and Y is 0.125 inches.

### Note

If the distance specified is so small as to make the grid appear very dense on the screen, the data display window will hide the grid rather than allow it to make the window contents unreadable. To see the grid, zoom in on the window contents, expand the window, or use a larger distance setting.

Select X and Y values for **Snap Grid per Display Grid**. This determines the number of grid points per linear inch, relative to the number of displayed dots or lines per linear inch. The default setting for both X and Y is 2 (that is, grid points occur twice as frequently along a given length as the display indicates). Increase the value to add more grid points between the displayed grid markings. In the illustration below, with X and Y set to 2, the red dots represent the displayed grid points and the hollow circles represent the hidden grid points between them.



### Note

The value of **Snap Grid per Display Grid** is required to be an integer in the range of 1 to 100.

## Active Snap Mode

Under **Active Snap Mode** on the **Grid/Snap**, use the checkbox to enable or disable grid snap mode. (It is enabled by default.)

Enabling snap mode does not, by itself, cause any existing object to align itself to the grid. Even when snap mode is enabled, objects snap to the grid only when they are dragged.

**Note**

Grid/Snap mode can also be enabled or disabled without opening the **Preferences** window, by checking or unchecking **Snap Enabled** on the **Options** menu of the data display. The same can be done using the relevant hot-key (which, by default, is Ctrl-E).

## Adding Date and Time to a Data Display

You can add the current date and time to a data display using the AEL function *date\_time()*. You can add this (or any other AEL expression) to a data display using an equation, then display the results on a plot. In the procedure below, date and time are displayed in a list.

1. Click the **Equation** button on the palette or choose **Insert > Equation**.
2. Position the pointer on the display area and click the mouse button.
3. The Enter Equation dialog box appears. Enter the equation as **current\_date\_time=date\_time()** . (Use any variable name on the left side of the equation and the AEL function on the right side of the equation.) Click **OK**.

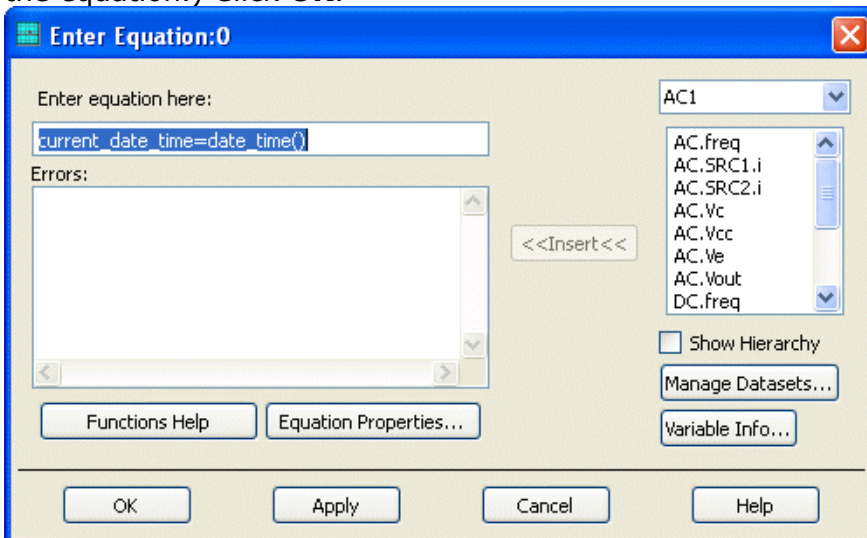

4. From the tool bar on the left side of the Data Display window, click the *List* button, move the pointer into the display area of the window, and click.
5. In the dialog box that appears, select **Equations** from the *Datasets and Equations* drop-down list.
6. Select the variable (in this case, *current\_date\_time*) and click **Add**. Click **OK**.

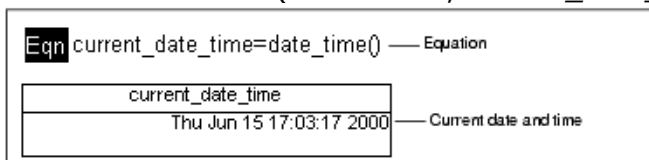

Note this is not a date/time stamp, it is updated to reflect the current date and time.

**Note**

You can add variables to an ADS schematic to display current date and time, plus other design and system information. For more information, see *Schematic Capture and Layout* (usrguide) documentation.

# Markers

Markers enable you to read data values at specific points on a trace. They return the independent and dependent values of the data.

*Marker Types* summarizes the types of markers available in Data Display:

Marker Name	Description
Normal	Returns value from any point on a trace
Delta	Displays the difference between two markers
Offset	Finds a fixed offset from a reference marker
Peak	Finds the localized peak values of a trace
Valley	Finds the localized valleys of a trace
Max	Finds the data points that reflect the maximum data values
Min	Finds the data points that reflect the minimum data values
Line	Displays all trace values at a specific independent value

For more information refer to [Delta Mode](#), [Offset Marker](#), [Peak and Valley Markers](#), [Line Markers](#) and [Max and Min Markers](#).

When a marker is inserted, the following items appear on the display page:

- The marker symbol.
- The marker readout, which returns the data at that point on the trace.
- Marker labels, one on the trace and one in the readout. This is helpful when you have multiple markers displayed.

The figure below shows a marker inserted onto a trace and the data returned from that point on the trace.

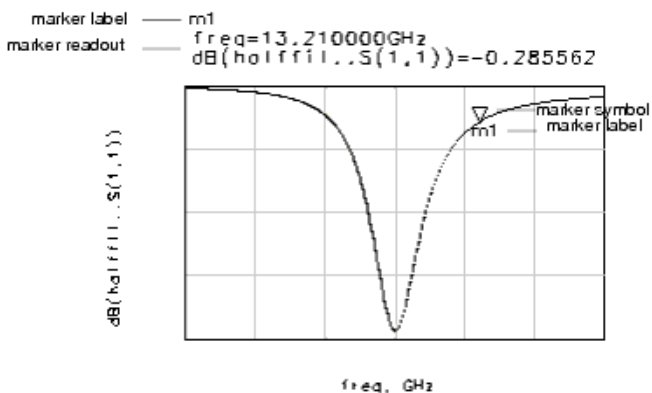

Markers can also be used in equations. For information refer to *Using Markers in Equations. (data)*

## Inserting Markers

You can insert one or more markers onto a trace.

To insert a marker:

1. Choose **Marker > New <Marker Type>** or select the appropriate marker from the *Marker* toolbar.

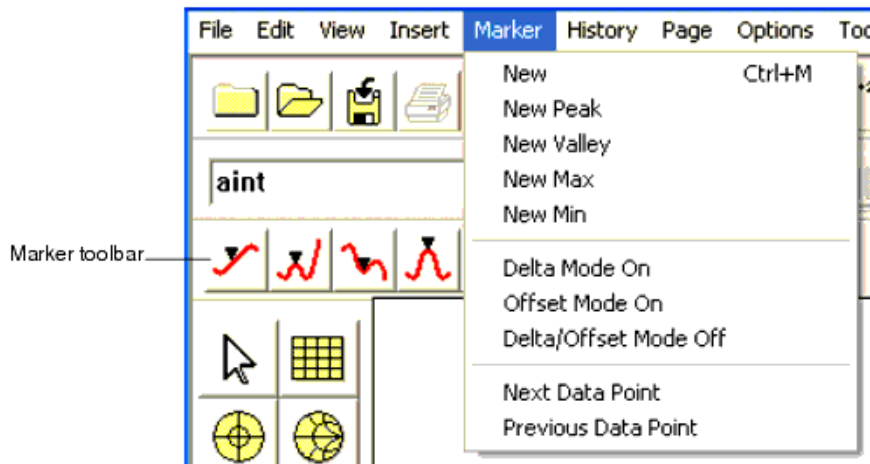

2. The Insert Marker dialog box appears. Position the pointer on the trace where you want to insert the marker and click.
3. The dialog box is automatically dismissed.

You can then drag the marker and move it to any position along the trace. An active marker readout is displayed to help you position the marker.

The marker data appears next to the marker. To keep your plot uncluttered, enlarge the data display window, select the marker readout text, and drag it off to one side of the plot.

## Moving Markers

There are three ways to move markers:

- Drag the marker to any position along a trace. An active marker readout is displayed to help you position the marker.
- Select the marker and move it to the next or previous data point by:
  - Using the arrow keys on your keyboard
  - Using the arrow buttons on the Marker toolbar
  - Selecting *Next Data Point* or *Previous Data Point* from the *Marker* pulldown menu or from the marker popup menu
- Change the value and units of the independent variable in the marker readout. For more information, refer to [Editing the Marker Readout](#).

## Editing Markers

You can change the properties of an individual marker using the Edit Marker Properties dialog box.

### Note

Any changes that you make will only affect the currently selected marker. To change the properties for all markers added subsequently, refer to [Setting Marker Preferences](#).

To edit a marker, double-click the marker or the marker readout to display the Edit Marker Properties dialog box. The dialog includes four tabs, as described below.

### Main Marker Properties Tab

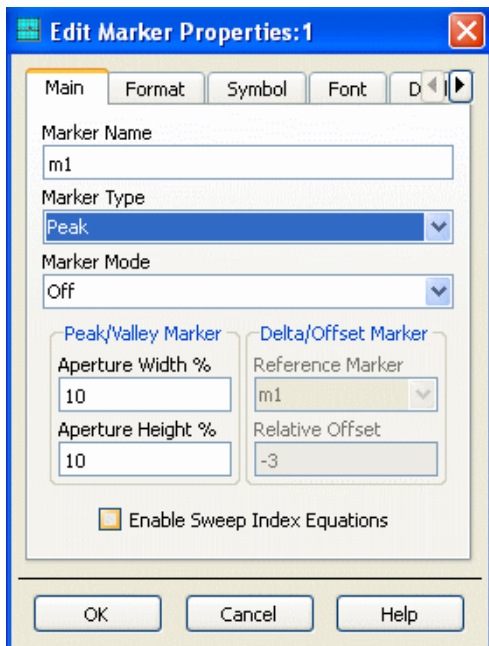

Use the *Main* tab to:

- Change the marker label text in the *Marker Name* field

**Note**

Markers can be used in equations by adding the marker label to an equation. Be aware that if you use a marker label in an equation and then change the marker label in the *Marker Name* field, you must update your equation with the new marker label.

- Change the marker type in the *Marker Type* field
- Select **Delta** or **Offset** mode in the *Marker Mode* field, or **Off** to deactivate those modes
- Control the aperture size using the *Peak/Valley Marker* area
- Select the reference marker in the *Delta/Offset Marker* area
- Enter the relative offset value in the *Delta/Offset Marker* area
- The check box **Enable Sweep Index Equation** allows you to create an equation that is the data index of where the marker is currently located. The equation that is created has the following form **<marker name>\_<sweep name>\_index**.

### Format Marker Properties Tab



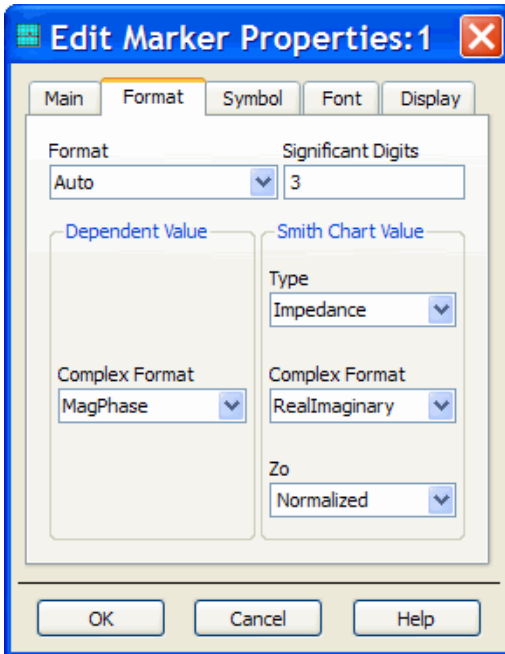

Use the *Format* tab to:

- Select a readout format.
- Select a complex format (for dependent values).
- Specify the number of significant digits.
- Select Smith Chart Values (type, complex format, and Zo).

### Symbol Marker Properties Tab

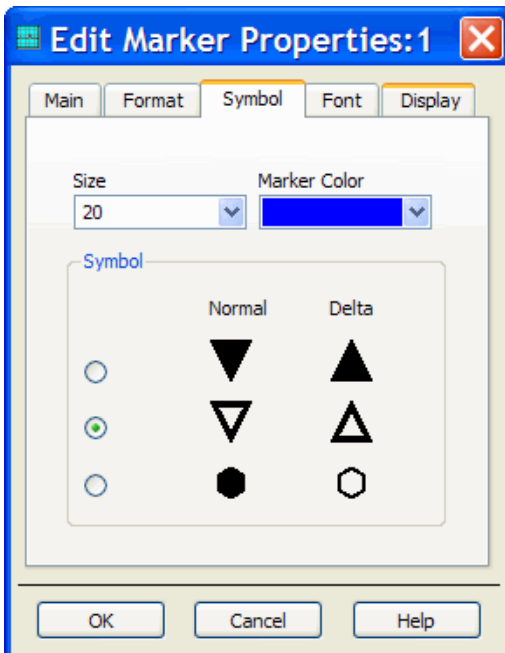

Use the *Symbol* tab to:

- Select the size of the symbol.
- Select the marker color.
- Select the symbol type for normal and delta markers (the illustration above shows the available types).

## Font Marker Properties Tab

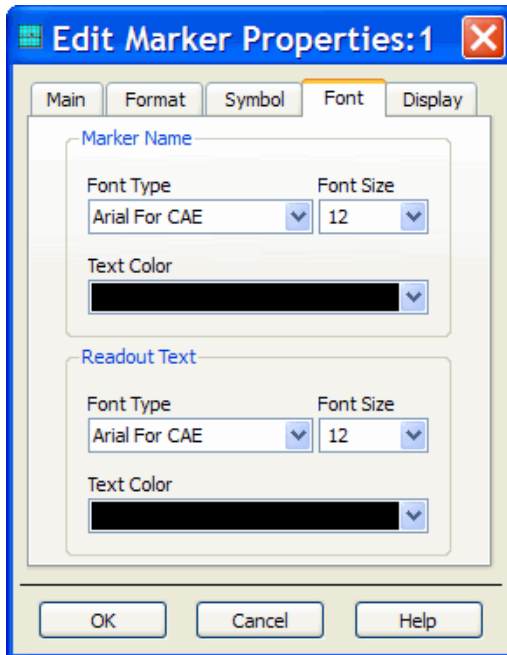

Use the *Font* tab to:

- Select the font type, font size, and text color for the marker name.
- Select the font type, font size, and text color for the marker readout text.

## Display Marker Properties Tab

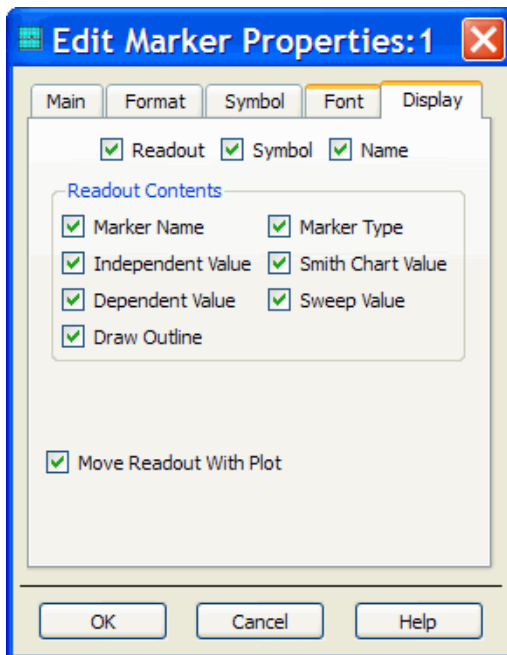

Use the checkboxes on the *Display* tab to:

- Choose whether or not the readout, symbol, and name for the marker will be displayed (at least one of the three must be left visible).
- Choose whether or not the various elements of the marker readout contents will be displayed.
- Choose whether or not the readout for a marker will be moved on the data display window when

the plot containing that marker is moved. (Note that this behavior is not saved between sessions, and that default behavior is for the readout to move with the plot.)

## Changing Marker Type

You can change the type of an existing marker in one of two ways:

- Double-click the marker or its readout and use the Edit Marker Properties dialog box to select a different type of marker.
- OR
- Select the marker and right-click the mouse, then select a different marker type from the popup menu.

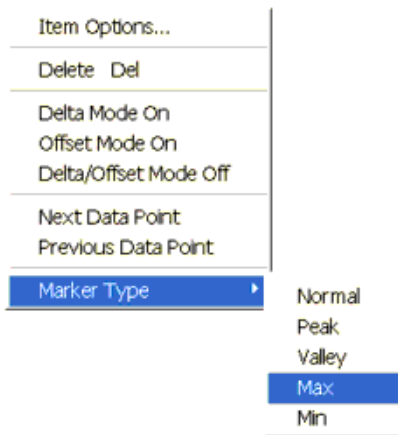

## Deleting Markers

To delete markers, do the following:

1. To delete a single marker, single-click on the marker. For multiple markers, hold the **Shift** key down and single-click on each marker of interest.
2. Press the **Delete** key or choose **Edit > Delete**.

## Setting Marker Preferences

Marker preferences set the default marker properties and determine the appearance of a marker when it is inserted onto a plot.

Marker preference changes will apply to all markers created after the changes were made and saved. To change properties for an existing marker, refer to [Editing Markers](#).

To save and reuse preference settings, you can create a preferences file that can be read by the data display. For more information on how to create and use such a file, refer to *Setting Data Display Preferences* (data).

To set marker preferences, do the following:

1. Choose **Options > Preferences** to display the Preference dialog box.
2. Click the *Marker* tab to edit the marker preferences.

There are five tabs under the Marker tab:

- Main
- Format
- Symbol
- Font
- Display

### Marker *Main* Preferences Tab

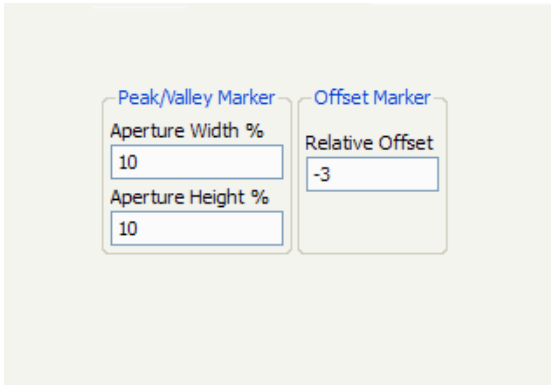

Use the *Main* tab to:

- Select the aperture width and height for a peak/valley marker.
- Set the relative offset for an offset marker.

### Marker *Format* Preferences Tab

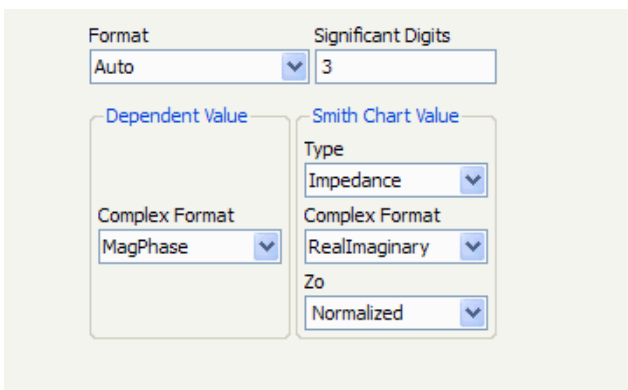

Use the *Format* tab to:

- Select a readout format.
- Select a complex format (for dependent values).
- Specify the number of significant digits.
- Select Smith Chart Values (type, complex format, and Zo).

### Marker *Symbol* Preferences Tab

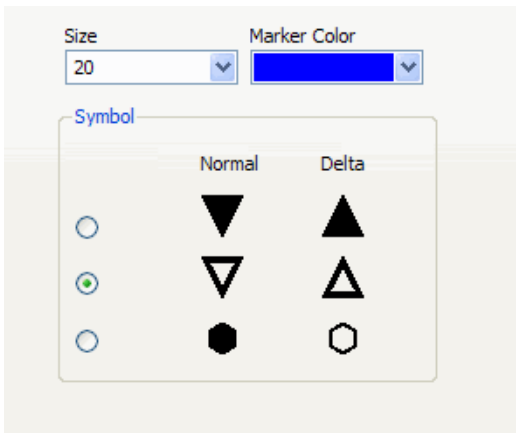

Use the *Symbol* tab to:

- Select the size of the symbol.
- Select the marker color.
- Select the symbol type for normal and delta markers (the illustration above shows the available types).

### Marker *Font* Preferences Tab

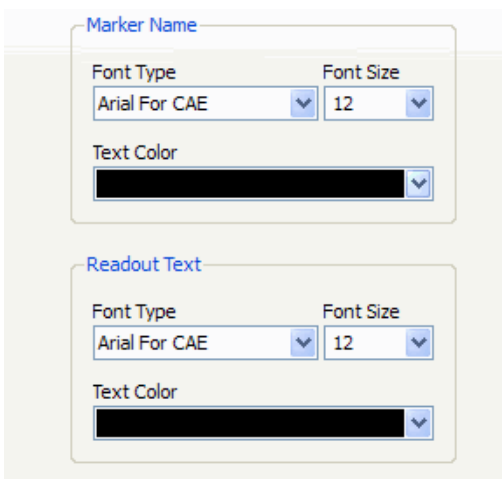

Use the *Font* tab to:

- Select the font type, font size, and text color for the marker name.
- Select the font type, font size, and text color for the marker readout text.

### Marker *Display* Preferences Tab

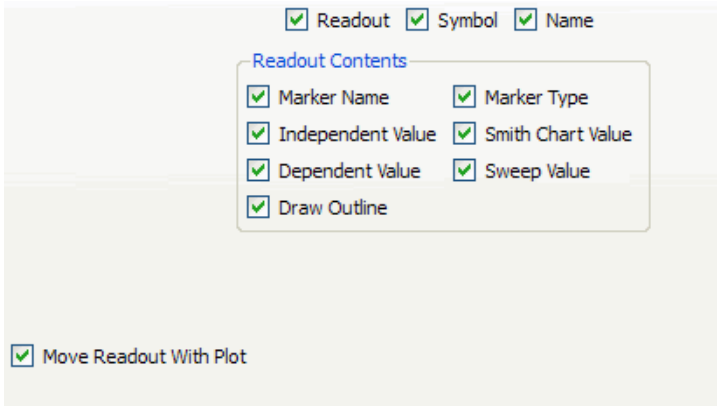

Use the checkboxes on the *Display* tab to:

- Choose whether or not the readout, symbol, and name for the marker will be displayed (at least one of the three must be left visible).
- Choose whether or not the various elements of the marker readout contents will be displayed.
- Choose whether or not the readout for a marker will be moved on the data display window when the plot containing that marker is moved.

## Marker Readout

A marker readout includes:

- A label that matches the label on the marker
- The value of the independent variable
- The value of the dependent variable. Values from polar plots and Smith charts are displayed in real and imaginary components; markers on Smith charts also display either impedance or admittance. Values from rectangular and stacked plots are returned in scalar format.
- The sweep value of the marker's position in the data
- The marker type (displayed for all marker types except for Normal marker)

```

Marker label   ——m4
Independent variable ——ind Delta=9.000E9
Dependent variable ——dep Delta=-3.270
Sweep indicator ——(2,2)
Marker type   ——Valley, Delta Mode ON
  
```

## Editing the Marker Readout

The independent value of the marker readout can be edited directly, thus avoiding the need to drag the marker to a particular value. The following example illustrates the position of the independent variable value and units.

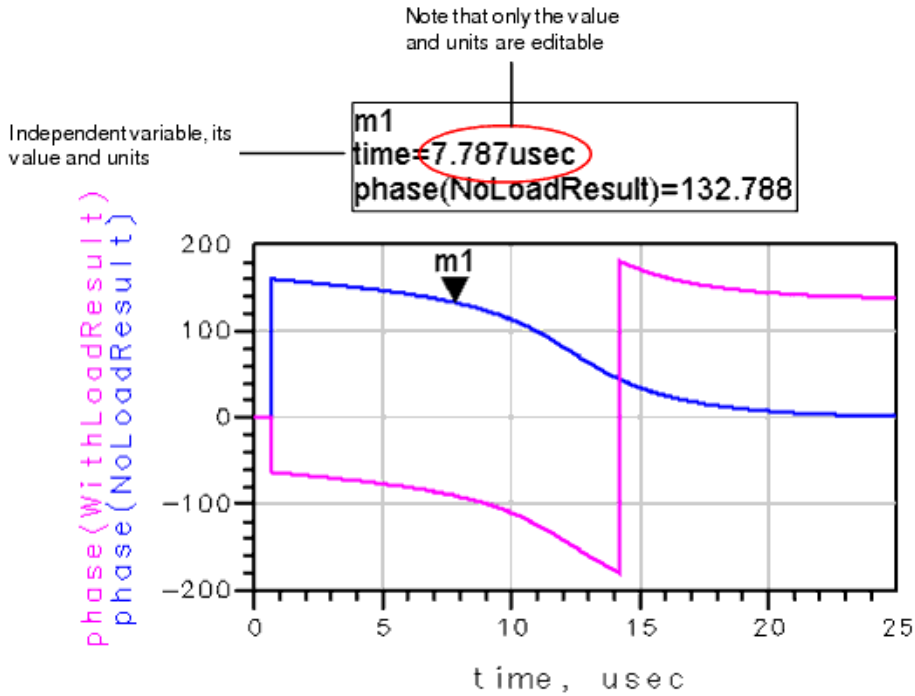

To edit the independent variable value:

1. Click the independent variable value and units portion of the marker readout. The text will turn red.
2. Enter the new value and/or units. The marker indicator will move to the point nearest the entered value. Conversions between understood units will be updated automatically.

**Note**

The units evaluator only understands a limited set of units. For instance, in the example shown above, *usec* is understood as microseconds (i.e. 10e-6 seconds); however, *micro secs* is not.

## Delta Mode

The difference between two markers can be displayed using delta mode. The readout of the selected marker changes relative to the marker that you assign as the reference.

You can select any markers in a data display for comparison in delta mode. The markers can be on the same trace, on different traces in the same plot, or on different traces in different plots. The delta marker equation is:

$$\text{delta} = \text{delta marker} - \text{reference marker}$$

The following example shows two markers used in delta mode. Note that the marker in delta mode is rotated. The reference marker is unchanged.

m2 is the delta. It displays m2 - m1 (delta marker - reference marker) results.  
 $VCE_{m2} - VCE_{m1} = 3 - 3 = 0$   
 $IC_{im2} - IC_{im1} = 10mA - 2mA = 8mA$

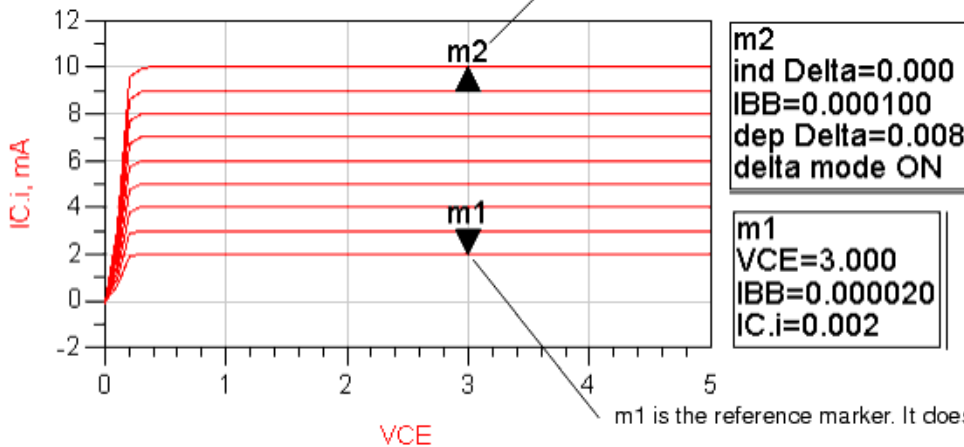

To activate delta mode:

1. Hold the **shift** key and select the markers you want to display in delta mode. Be sure to include the reference marker.



#### Hint

As an alternative to selecting markers, you can select the marker readouts.

2. Choose **Marker > Delta Mode On** or right click and select **Delta Mode On** from the popup menu.
3. A dialog box appears listing the selected markers. Select one marker from this list to be the reference marker.
4. Click **OK**.

To deactivate delta mode Choose **Marker > Delta/Offset Mode Off** or right click and select **Delta/Offset Mode Off** from the popup menu.

You can also activate and deactivate delta mode using the Edit Marker Properties dialog box. For more information refer to [Editing Markers](#).

## Offset Marker

An Offset marker enables you to set a fixed offset from a reference marker on a linear trace contained in a rectangular plot. When you move the reference marker, the Offset marker moves with it, keeping the relative offset unchanged.

The Offset Marker snaps to the closest actual data point that matches the value you define in the Edit Marker Properties dialog box. You can control which side of the reference marker the Offset marker will reside.

The following example shows two markers used in offset mode. Note that the marker in offset mode is rotated. The reference marker is unchanged.



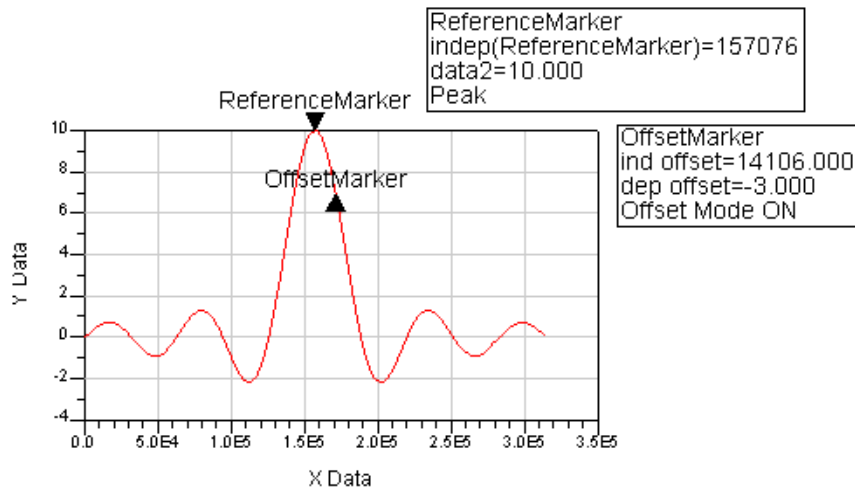

To activate offset mode:

1. Hold the **shift** key and select the markers you want to use in offset mode.



**Hint**

As an alternative to selecting markers, you can select the marker readouts.

2. Choose **Marker > Offset Mode On** or right-click and select **Offset Mode On** from the popup menu.
3. A dialog box appears listing the selected markers. Select one marker from this list to be the reference marker.
4. Click **OK**.



**Note**

When you activate offset mode in this way, the offset is set to the default relative offset. To change the default offset, use the Preference dialog box. For more information refer to [Setting Marker Preferences](#). If you need to set a unique offset each time, activate offset mode using the Edit Marker Properties dialog box. For more information refer to [Editing Markers](#).

To deactivate offset mode use one of the following options:

- Choose **Marker > Delta/Offset Mode Off** or right-click and select **Delta/Offset Mode Off** from the popup menu.

You can also deactivate offset mode using the Edit Marker Properties dialog box. For more information refer to [Editing Markers](#).

**Note**

When you attempt to add an Offset marker on a trace or a plot that doesn't support this marker type, the marker is automatically converted to delta marker and a warning message pops up. The warning will also occur if you change the trace type or if the simulation results change the automatic trace type to an unsupported type.

## Peak and Valley Markers

Peak and Valley markers enable you to find the localized data peaks and valleys of a linear trace contained in a rectangular plot.

**Note**

The value of each peak may be lower than the maximum data value for the entire trace, and the value of each valley may be higher than the minimum data value for the entire trace. To find the minimum and maximum data values use the *Min* and *Max* markers.

You can insert and drag Peak and Valley markers like any other marker. These markers snap to peak or valley points automatically, and you can then move them to the next/previous peak/valley in different ways:

- Use the arrow keys on your keyboard.
- Use the arrow buttons on the Marker toolbar.
- Select *Next data point* or *Previous data point* from the Marker pulldown menu or popup menu.

**Note**

When a Peak or Valley marker is placed on a trace or a plot that doesn't support this marker type, the marker is automatically converted to a supported marker type (Max/Min) and a warning message pops up. The conversion also occurs if the trace type is changed, either by you or by simulation results, to a type that doesn't support Peak and Valley markers. Note that the markers are not automatically converted back to their original type even if the data is restored to its original type.

## Peak and Valley Marker Aperture

A marker *aperture* enables you to selectively include or exclude data peaks and valleys. The aperture is a box that surrounds the marker and is used to identify peaks. It reflects the percentage of the maximum data range. To include smaller peaks/valleys, make the aperture smaller, and to reject smaller peak/valley locations, make the aperture larger.

The following figures demonstrate the role of the marker aperture:

- The first figure is an example of an invalid peak, because the data inside the aperture does not form a peak (in a valid peak the slope of the data leading to the peak is positive and the slope of the data trailing the peak is negative).

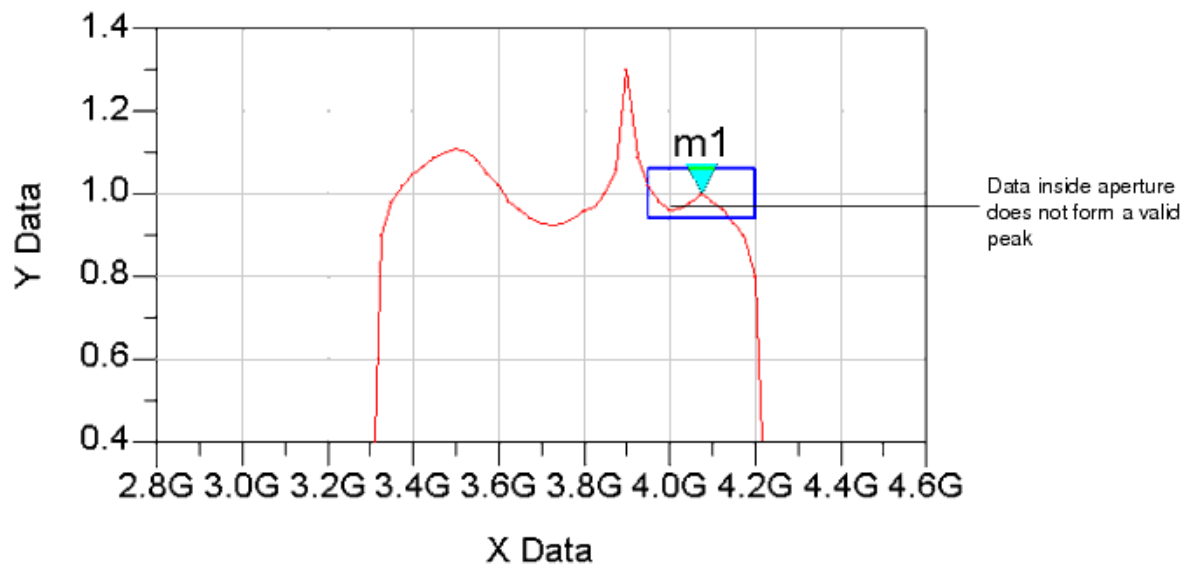

- Reducing the size of the aperture (as shown in the next figure) makes the marker location a valid peak.

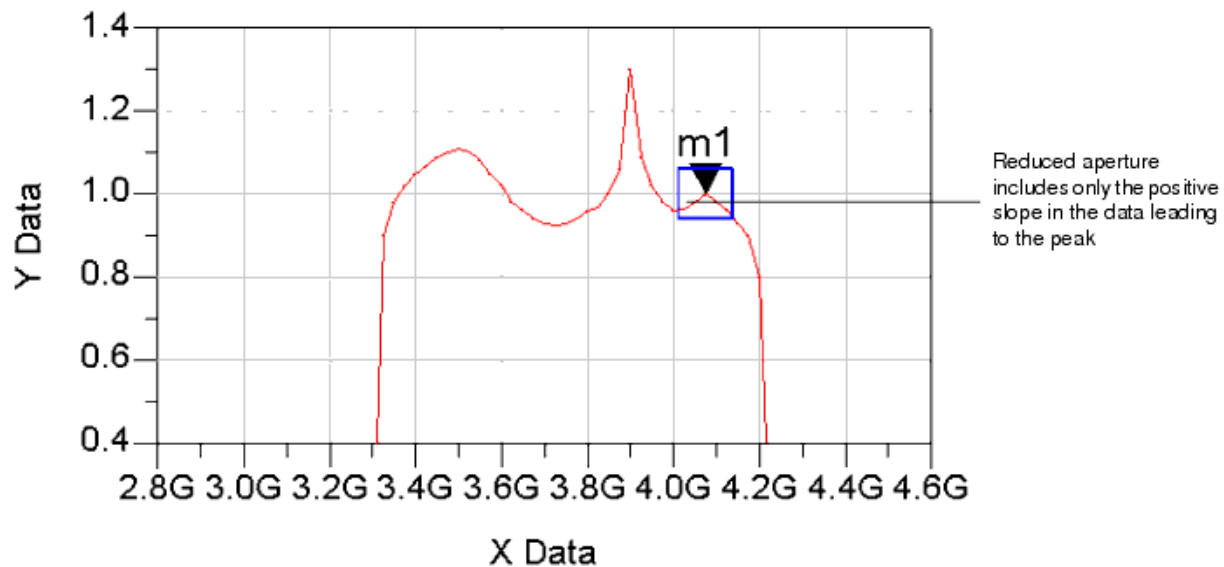

The aperture enables you to reject peaks that you are not interested in, an important capability with signals that have many "noisy" peaks.

To change the aperture size...

1. Double click a Peak/Valley marker or its readout to display the Edit Marker Properties Dialog box.
2. Select the Main tab.
3. Use the *Aperture Width %* and *Aperture Height %* fields in the *Peak/Valley Marker* area to change the width and height of the marker.
4. Click **OK** to save the changes and close the dialog box

To change the *default* aperture for all newly created Peak and Valley markers, refer to [Setting Marker Preferences](#). The new default aperture will apply to all markers created after the changes were made and saved.

## Line Marker

A Line marker displays all trace values at a specific independent value. It will only be available in Rectangular and Stacked Plots. It is taken from digital simulators which have a marker that you place on the screen and it goes from top to bottom of the trace area and displays values of all the traces.

You can insert a line marker from the Menu item as shown:

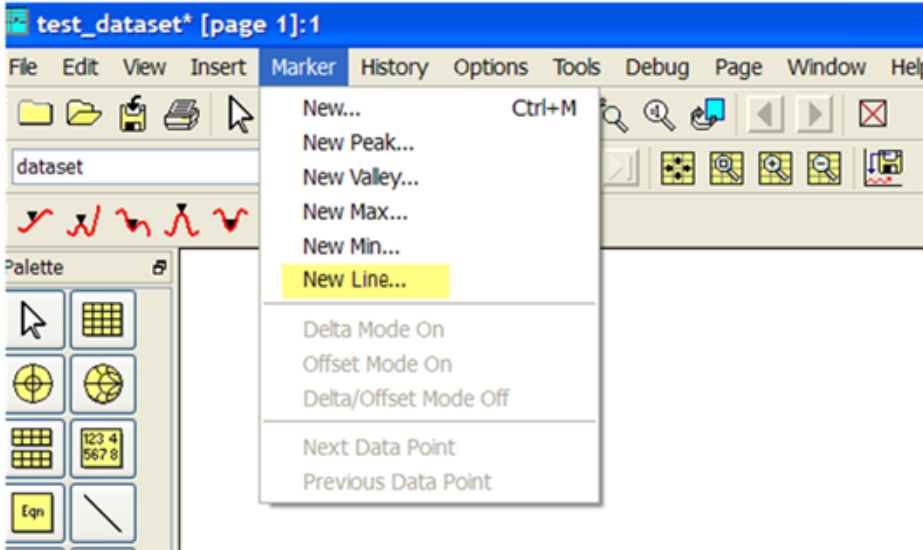

**Figure: Menu Item for Line Marker**

A new item is also added in the tool bar for quicker access to line marker:

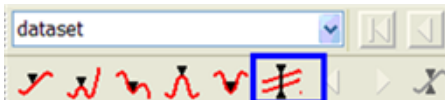
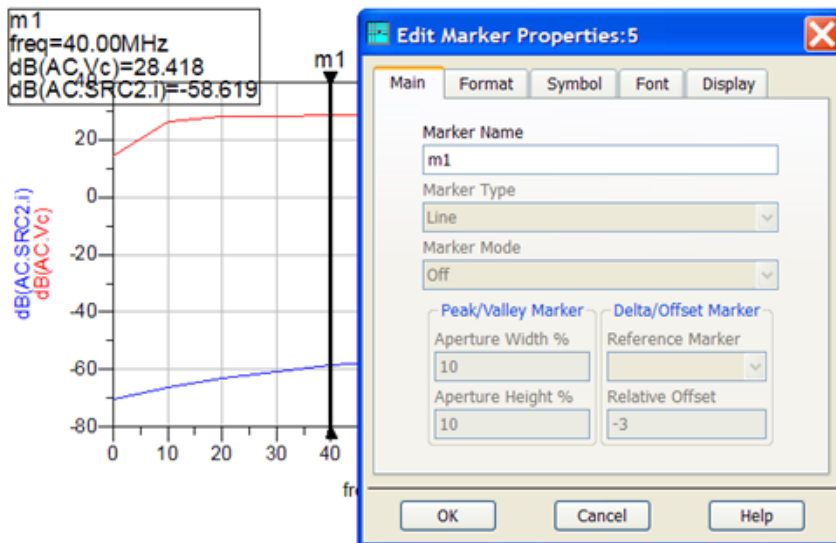

**Figure: Toolbar symbol for Line Marker**

Line marker is displayed from top to bottom of the trace area and displays values of all the traces. The readout contains: marker name, independent value and dependent values from all traces. Editing the indep value in readout can move the line marker. Line marker supports drag, move, snapping as normal marker does. Line marker's properties can be changed like normal marker in marker dialog.

**Special features of Line Markers:**

1. Line marker is displayed from top to bottom of the trace area and displays values of all the traces.
2. The readout contains: marker name, independent value and dependent values from all traces. Editing the indep value in readout can move the line marker.
3. Line marker supports drag, move, snapping as normal marker does. Line marker's properties can be changed like normal marker in marker dialog.



4. Line marker only supports the rectangular plot and stacked plot. When we insert the line marker into other plots (such as, smith, polar, etc.), the following warning dialog shows up.

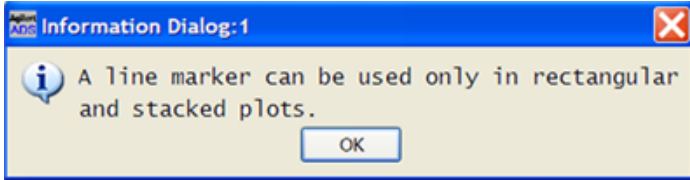

- Line marker can be inserted into the plot directly, rather than the trace. This is shown in the following snapshot. The red-cross point is the place where user inserts the marker. Because the inserting point is closer to 5 than 4, the new line marker will be put on the 5.

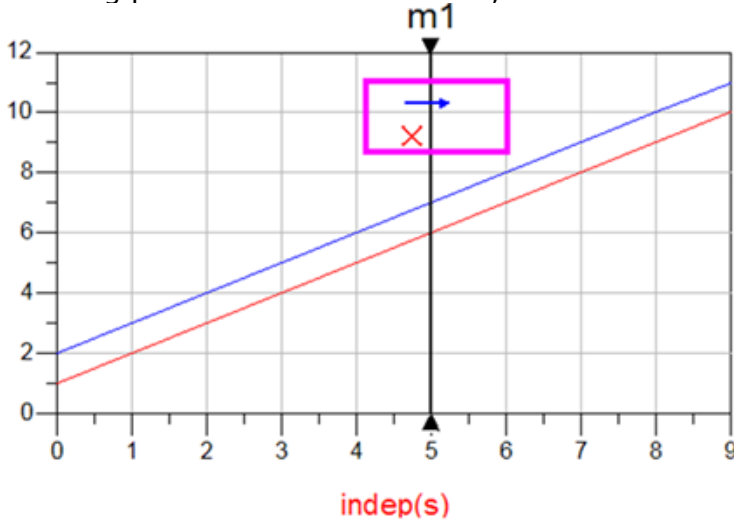

- Line marker doesn't support two different X axis for traces. If you try to do so, you get the following error message:

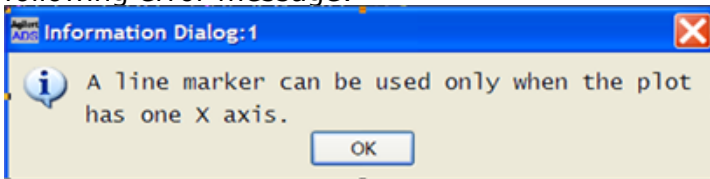

- Line marker doesn't apply to the Delta or Offset models.
- Line marker currently only supports max 25 traces or sub traces. This provides a good tradeoff between performance and capacity.

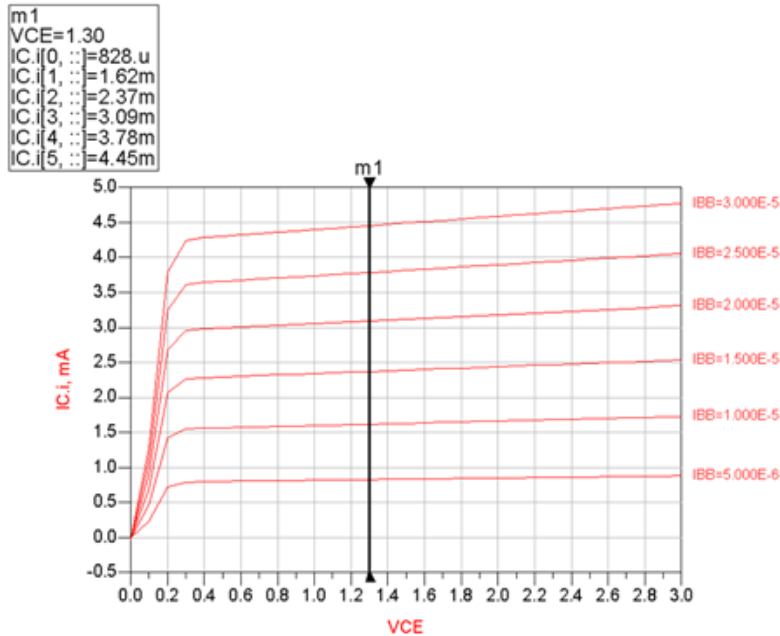

- Calculation for line marker is based on the concrete values for trace and the readout can be updated according to traces for both rectangular plot and stacked plot, like following:

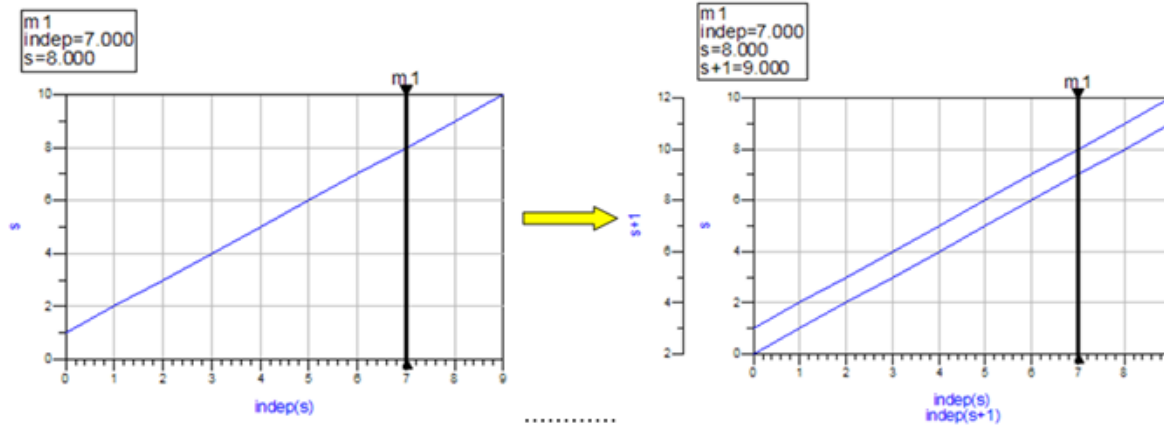

## Max and Min Markers

The Max marker snaps to the maximum data point of a trace, and the Min marker snaps to the minimum data point of a trace.

You can only move Max and Min markers on a trace if there are multiple (equal) maximum data points or minimum data points on the same trace.

To move a Max/Min marker to the next or previous Max/Min data point, select the marker and...

- Use the arrow keys on your keyboard
- Use the arrow buttons on the Marker toolbar
- Select *Next Data Point* or *Previous Data Point* from the *Marker* pulldown menu or from the marker popup menu

# Snapshot

This is an additional feature of Data Display. If you are running a long simulation and you want to look at data for a particular point in your design, or you just want to check the progress of your simulation, you can take a *Snapshot* of the simulation results to quickly view the data.

## Snapshot in ADS

To launch a snapshot during a simulation from an Advanced Design System schematic window choose **Simulate > Snapshot**.

When a snapshot is triggered in ADS, the snapshot display is updated soon after the next available swept point is done. If a previous request is being processed, the subsequent request is ignored and following status window is displayed:

 Snapshot is being processed, please wait...

The dataset is then updated and the data display window is launched.

### Note

If the data display window associated with the particular design or simulation has been previously configured, the window should display the appropriate graph or output. However, if you have not configured the data display window for your specific simulation, an empty data display window that includes the dataset attached may appear.

Some additional details for ADS snapshot:

- A snapshot request that is sent after a simulation is completed will be ignored.
- Snapshot is not available for Momentum simulations.
- Snapshot is supported for remote simulations.
- Results of source currents (e.g. include, I-Probe) and voltages of named nodes can be displayed in snapshot; however, measurement data are not always valid. If the measurement variable is defined on a point base (i.e. does not cross sweep points), and it is defined in the output plan inside the analysis, it can be displayed in snapshot. Otherwise, the data will be invalid.

# Eye Diagram FrontPanel

The Eye Diagram FrontPanel enables easy computation of waveform and eye diagram measurements. Many of the Eye Diagram FrontPanel measurement algorithms are derived from the Agilent Technologies Digital Communication Analyzer but with simplified implementation. The Eye Diagram FrontPanel supports the NRZ data type.

For information on measurement expressions specific to the Eye Diagram FrontPanel, see *FrontPanel Eye Diagram Functions* (expmeas) in *Measurement Expressions* (expmeas).

The Eye Diagram FrontPanel can be accessed from the Data Display window or from the Schematic window.

- To access the Eye Diagram FrontPanel from the Data Display window, choose **Tools > FrontPanel > Eye**.
- To access the Eye Diagram FrontPanel from the Schematic window, choose **DesignGuides > Signal Integrity Applications > Eye Diagram FrontPanel**.

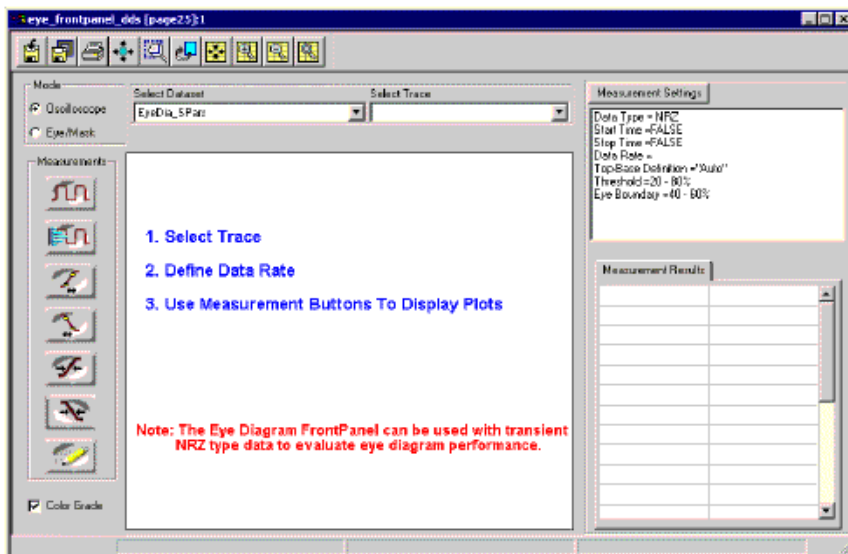

The basic measurements steps are:

1. Select Dataset.
2. Select Trace.
3. Define Data Rate in frequency units and define a measurement expression if required. See [Defining Data Rate](#).
4. Select Measurement buttons to display various measurements. See [Making Measurements](#).

## Defining Data Rate

When you select a trace name, the User Defined Data Rate dialog box appears. The selected trace name appears in the *Enter Trace Expression* field. This field can also be used to enter an expression. For example, the expression in the following dialog box produces the time difference differential NRZ waveform from a Harmonic Balance simulation.



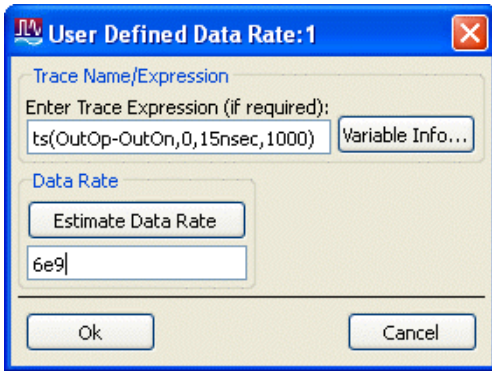

For waveform/eye diagram parameters, you need to define the NRZ data rate in the Data Rate field. If the data rate is unknown, click the Estimate Data Rate button to approximate the rate. For circuit envelope simulation data, you can define the expression to extract the NRZ baseband envelope using the frequency index.

## Changing Measurement Settings

The *Measurement Settings* button displays the *Plot Settings* dialog box. You can define the Start Time, Stop Time, Data Rate, Eye Boundary and Threshold Settings for waveform and eye diagram measurements. You can also change the color preference for traces.

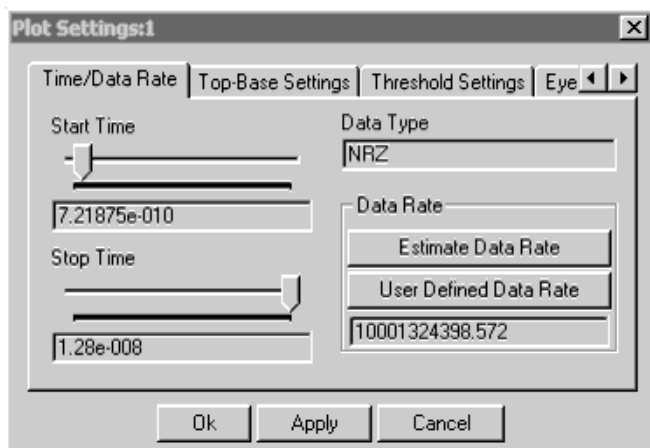

To enable trace color grading for rise, fall, and eye diagram traces, select the *Color Grade* check box located below the Measurement buttons.

## Making Measurements

The Eye Diagram FrontPanel has two different measurement modes:

- [Oscilloscope Mode](#)
- [Eye/Mask Mode](#)

### Oscilloscope Mode

In Oscilloscope mode, all measurements are performed automatically. Some measurements, such as peak-to-peak jitter, require user intervention.

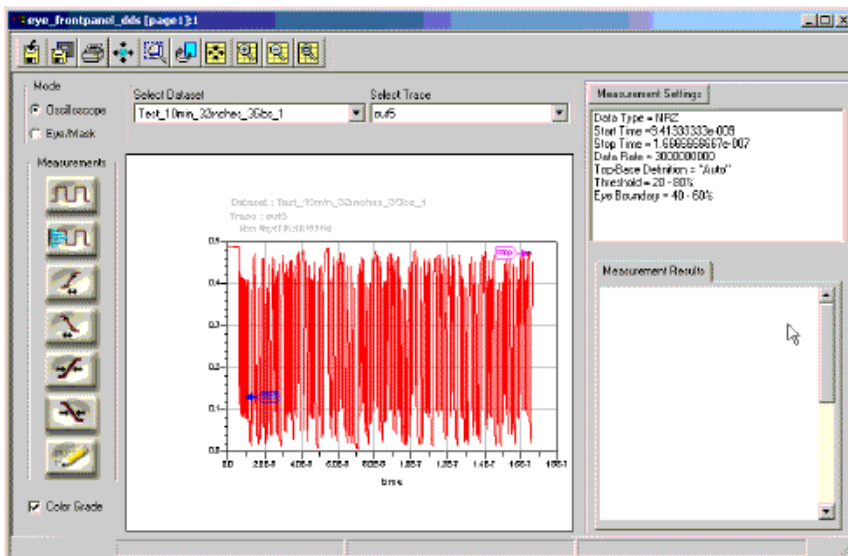

The *Waveform* button displays the time domain waveform.

The pointer maker on the waveform indicates the segment of the waveform used for parameter measurement. To change the start and stop values, click the *Measurement Settings* button then edit the *Plot Settings* dialog box.

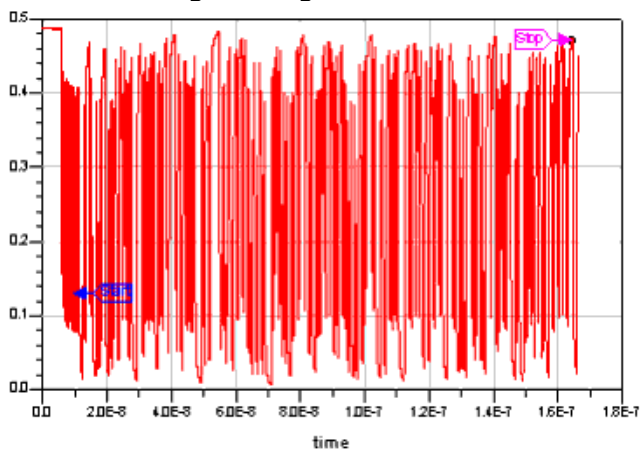

The *Amplitude Histogram* button displays the amplitude histogram waveform.

A default sampling rate of 451 samples per wavelength across the time axis and 321 samples across the amplitude axis is used to construct the amplitude histogram. This provides an idea of the level one and the zero of the waveform. To smooth out the noisy display of the amplitude histogram, increase the smoothing factor by adjusting the *Smoothing factor* slider on the *Amplitude Histogram* dialog box. To readout the number of samples and amplitude information, adjust the *Marker* slider.

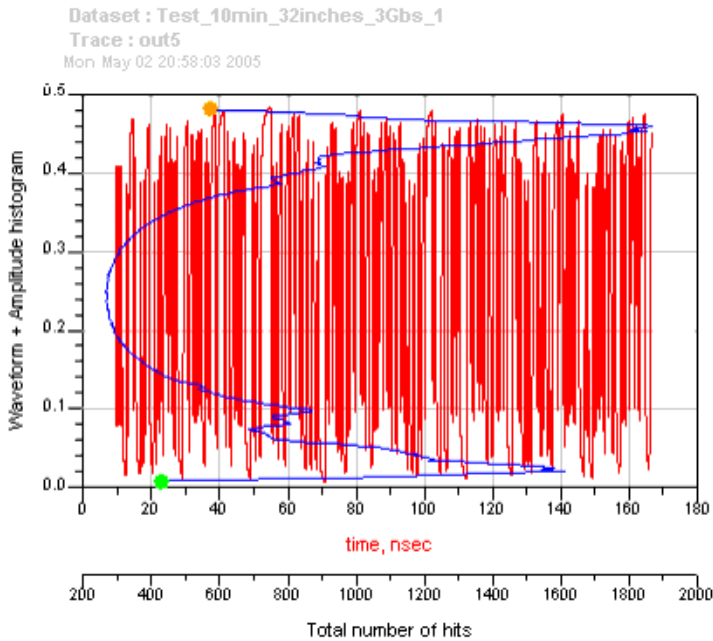

The *Rise Time Measurement* button displays the overlaid rising edge plot used for rise time computation.

Rise time is a measure of the transition time of the data on the positive (rising) edge of a waveform. The edge crosses through the lower, middle, and upper threshold levels. The rising edges, which do not cross through all three threshold levels, are not displayed and are not included in rise time computation. Horizontal histograms are created across lower, middle, and high threshold levels of this display. The mean values at low and high threshold levels are computed for rise time calculation. The default setting for the threshold levels are the 20% to 80% points on the transition. To change the default threshold settings, click the *Measurement Settings* button then edit the *Threshold Settings* tab in the *Plot Settings* dialog box.

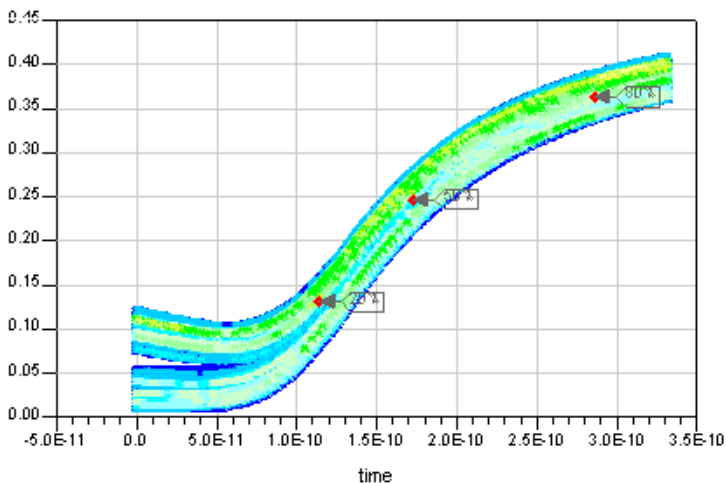

Pointer markers are placed at low, middle, and high threshold levels.



The *Fall Time Measurement* button displays the overlay falling edge plot used for fall time computation.

Fall time is a measure of the transition time of the data on the negative (falling) edge of a waveform. The edge crosses through the upper, middle, and lower threshold levels. The falling edges, which do

not cross through all three threshold levels, are not displayed and are not included in fall time computation. Horizontal histograms are created across lower, middle, and high threshold levels of this display. The mean value at low and high threshold levels is computed for fall time calculation. The default setting for the threshold levels are the 20% to 80% points on the transition. To change the default threshold settings, click the *Measurement Settings* button then edit the *Threshold Settings* tab in the *Plot Settings* dialog box.

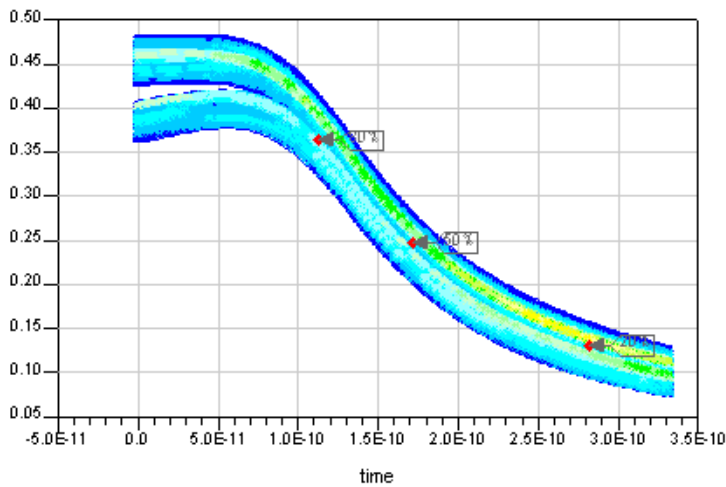

Jitter is a measure of the time variances of the rising or falling edges of a pulse waveform at the middle threshold. When a jitter measurement is selected, the instrument's measurement database is enabled. The waveform data that is sampled is accumulated in the measurement database.



The *Rising Edge Jitter Histogram* button displays the jitter histogram for the rising edge.

Jitter is a measure of the time variances of the rising or falling edges of a pulse waveform at the middle threshold. When a jitter measurement is selected, a measurement window is placed horizontally through the middle threshold. This measurement window is narrow in amplitude. A time histogram is then generated and the peak-to-peak jitter value is determined. RMS jitter is defined as one standard deviation from the histogram mean.

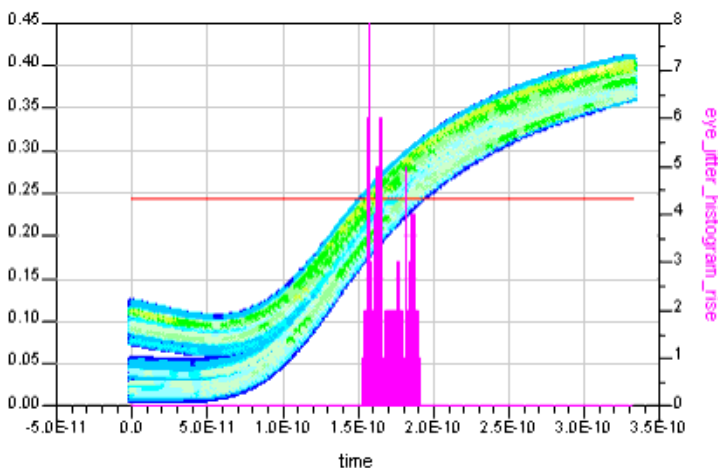

In the *Rise Histogram* dialog box, adjust the sliders on the Window Marker tab to define the rectangular area for jitter histograms. Adjust the sliders on the Curve Fit tab for Gaussian fitting of the jitter histogram. If the jitter histogram has a deterministic jitter component, the curve fit can be used to create a Gaussian curve in the tail region. The mean and standard deviation of this Gaussian curve is displayed.

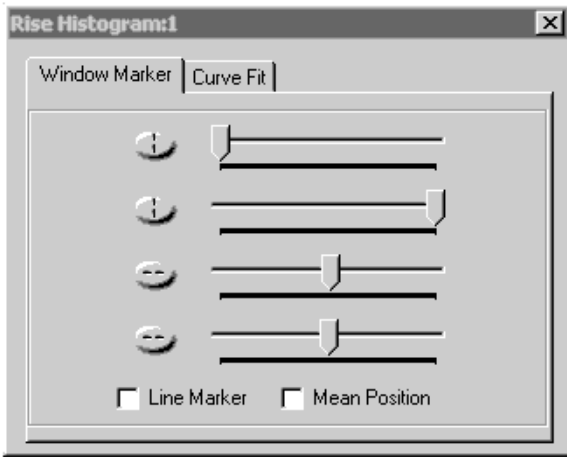

The *Falling Edge Jitter Histogram* button displays the jitter histogram for the falling edge.

Jitter is a measure of the time variances of the rising or falling edges of a pulse waveform at the middle threshold. When a jitter measurement is selected, a measurement window is placed horizontally through the middle threshold. This measurement window is narrow in amplitude. A time histogram is then generated and the peak-to-peak jitter value is determined. RMS jitter is defined as one standard deviation from the histogram mean.

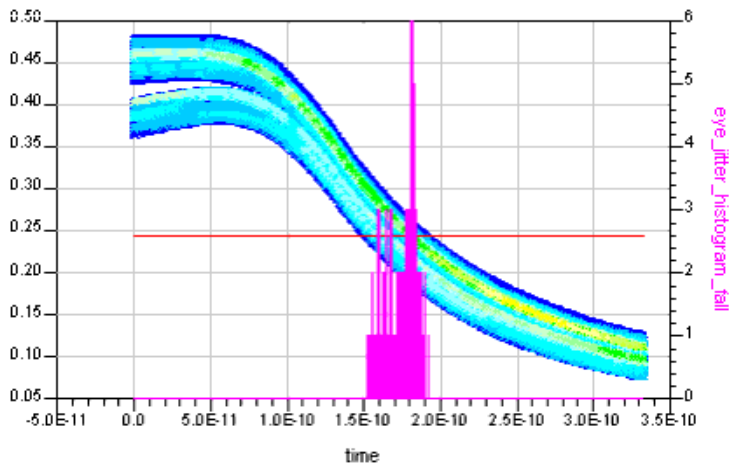

In the *Fall Histogram* dialog box, adjust the sliders on the Window Marker tab to define the rectangular area for jitter histograms. Adjust the sliders on the Curve Fit tab for Gaussian fitting of the jitter histogram. If the jitter histogram has a deterministic jitter component, the curve fit can be used to create a Gaussian curve in the tail region. The mean and standard deviation of this Gaussian curve is displayed.



The *Measurement Summary* button displays the measurement summary of the waveform parameters.

### Waveform Measurement Results

Start time	9.413E-9
Stop time	1.667E-7
Start index	1.412E3
Stop index	2.500E4
Sweep size	2.500E4
Data rate	3.000E9
Start measurement time	9.413E-9
Stop measurement time	1.644E-7
Minimum amplitude	0.007
Maximum amplitude	0.483
Low threshold	0.131
High threshold	0.363
Waveform level zero	0.053
Waveform level one	0.441
Waveform level mean	0.247
Waveform amplitude	0.388
Average rise time	1.719E-10
Average fall time	1.693E-10
1st period duty cycle	49.474
1st edge rise time	1.572E-10
1st edge fall time	1.507E-10
1st positive pulse width	3.299E-10
1st negative pulse width	3.370E-10
1st rising edge frequency	1.499E9
1st falling edge frequency	1.500E9
1st rising edge period	6.669E-10
1st falling edge period	6.666E-10
Rising edge jitter (pp)	3.769E-11
Rising edge jitter (rms)	1.119E-11

### Eye/Mask Mode

In Eye/Mask mode, the eye diagram is displayed for the user defined data rate and most measurements are performed automatically.

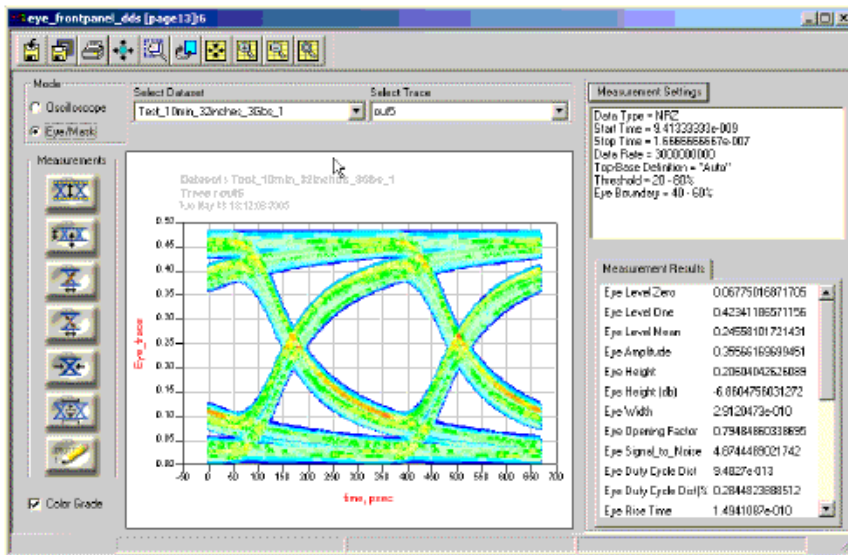

The *Eye Diagram* measurement button displays the eye diagram.



The *Eye Boundary* measurement button displays the detected eye crossing points, the level one and level zero, the 3 sigma points, and the eye boundary (40% -60%), which indicates the measurement region between eye crossing points. Use this display to verify and debug eye diagram measurements.



The *Eye Rise Time* measurement button displays the rising edge trace on the eye diagram.

The pointer markers indicate the threshold values. The eye diagram level one and level zero (computed within eye boundary region) are used to compute the threshold levels. Rise time is a measure of the transition time of the data on the waveform's positive (rising) edge. The edge crosses through the lower, middle, and upper threshold levels. The rising edges, which do not cross through all three threshold levels, are not displayed and are not included in rise time computation. Horizontal histograms are created across lower, middle, and high threshold levels of this display. The mean value at low and high threshold levels is computed for rise time calculation. The default setting for the threshold levels are the 20% to 80% points on the transition. To change the default threshold settings, click the *Measurement Settings* button then edit the *Threshold Settings* tab in the *Plot Settings* dialog box.

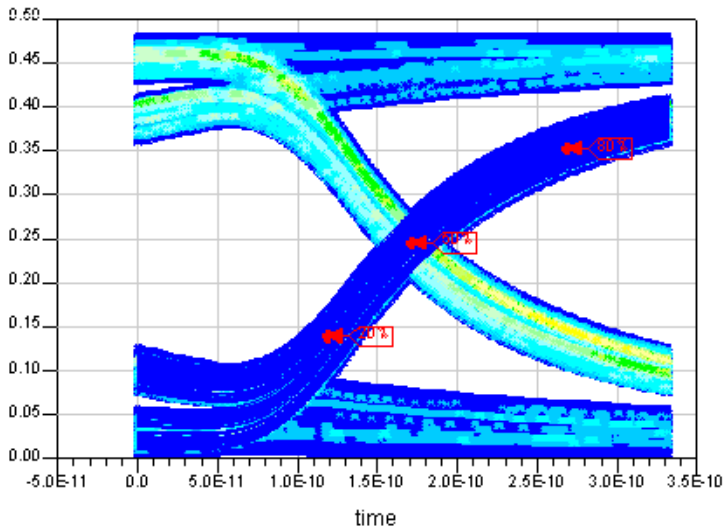

The *Eye Fall Time* button displays the falling edge trace on the eye diagram.

The pointer markers indicate the threshold values. The eye diagram level one and level zero (computed within eye boundary region) are used to compute the threshold levels. Fall time is a measure of the transition time of the data on the negative (falling) edge of a waveform. The edge crosses through the lower, middle, and upper threshold levels. The falling edges, which do not cross through all the three threshold levels, are not displayed and are not included in fall time computation. Horizontal histograms are created across lower, middle, and high threshold levels of this display. The mean value at low and high threshold levels is computed for rise time calculations. The default setting for the threshold levels are the 20% to 80% points on the transition. To change the default threshold settings, click the *Measurement Settings* button then edit the *Threshold Settings* tab in the *Plot Settings* dialog box.

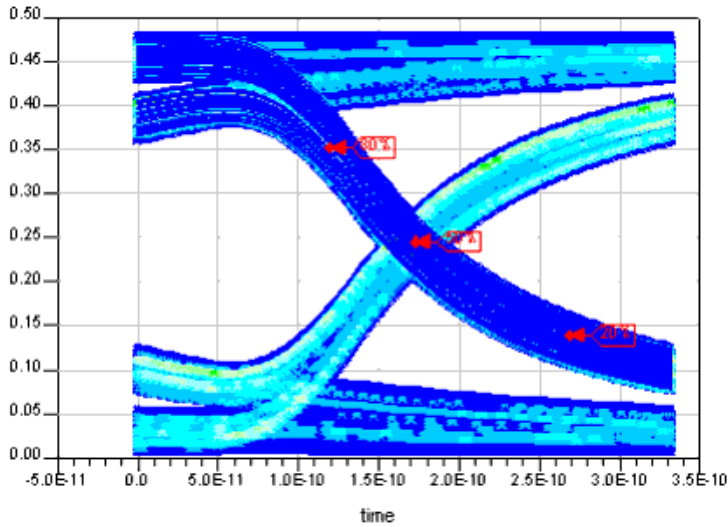

The *Eye Jitter Histogram* button displays the eye diagram jitter histogram.

NRZ Eye Jitter is the measure of the time variances of the rising and falling edges of an eye diagram as these edges affect the crossing point of the eye. When a jitter measurement is selected, a measurement window is placed horizontally through the middle threshold. This measurement window is narrow in amplitude. A time histogram is then generated and the peak-to-peak jitter value is determined. RMS jitter is defined as one standard deviation from the histogram mean.

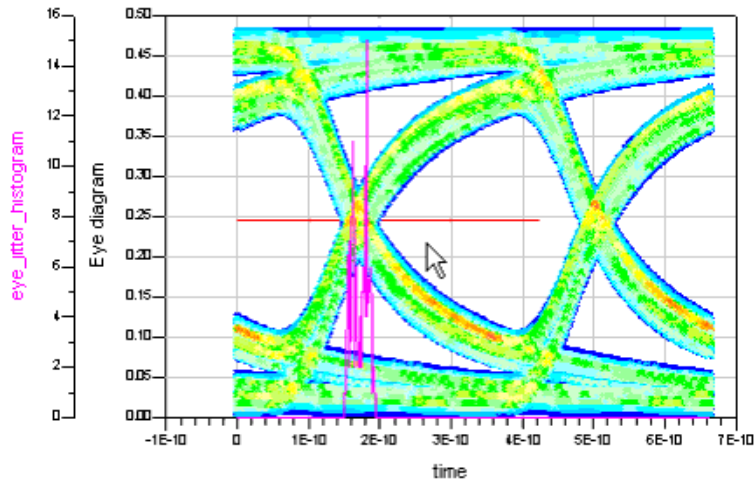

In the *Rise Histogram* dialog box, adjust the sliders on the Window Marker tab to define the rectangular area for jitter histograms. Adjust the sliders on the Curve Fit tab for Gaussian fitting of the jitter histogram. If the jitter histogram has a deterministic jitter component, the curve fit can be used to create a Gaussian curve in the tail region. The mean and standard deviation of this Gaussian curve is displayed.



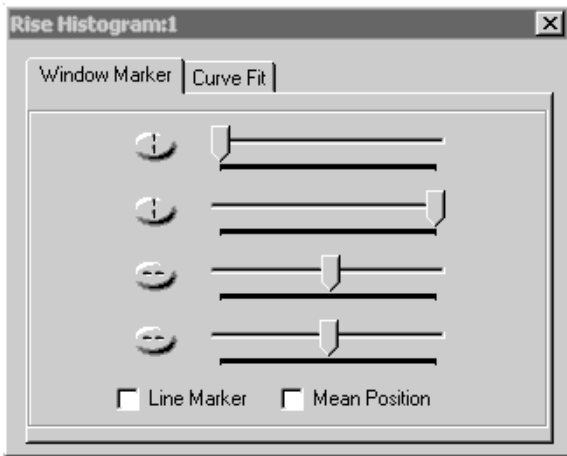

The *Eye Mask* button displays the Eye Mask overlaid on the eye diagram plot.

A mask is a template that defines the regions on the eye diagram plots. Mask testing enables you to verify that the displayed waveform complies with an industry standard waveform shape. To comply with the industry standard, the NRZ waveform must remain outside the mask regions. The mask tracks the waveform as the waveform's parameters are modified. The top, bottom, and center mask is automatically placed between the eye crossing points.

To modify the mask, adjust the slider bars in the *Eyemask* dialog box. You can alter the slope, the center mask length, height and position of top/lower mask. You can also save masks at a global, local, or workspace level.

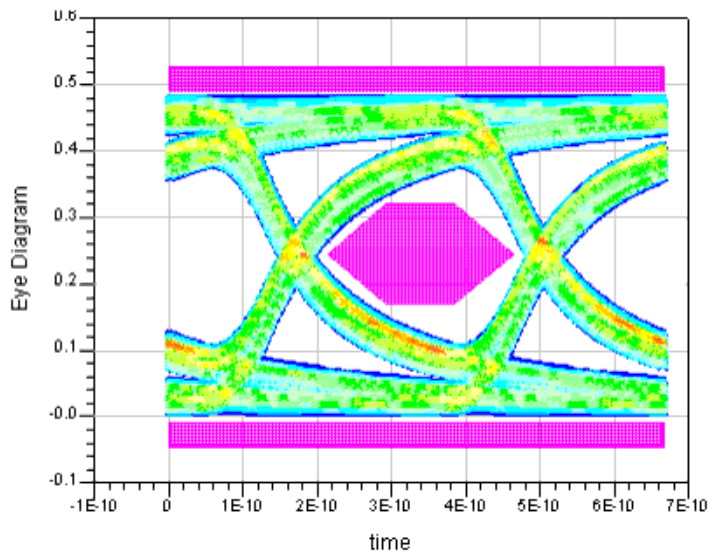

The *Measurement Summary* button displays the measurement summary of the eye diagram parameters.

Eye Diagram Measurements

Start time	9.413E-9
Stop time	1.667E-7
Start index	1.412E3
Stop index	2.500E4
Sweep size	2.500E4
Data rate	3.000E9
Start measurement time	9.413E-9
Stop measurement time	1.644E-7
Eye level zero	0.068
Eye level mean	0.246
Eye level one	0.423
Eye amplitude	0.356
Eye height	0.206
Eye height (db)	-6.860
Eye width	2.912E-10
Eye opening factor	0.795
Eye signal to noise	4.874
Eye duty cycle dist.	9.483E-13
Eye duty cycle dist. (%)	0.284
Eye crossing 1 time	1.716E-10
Eye crossing 1 amplitude	0.245
Eye crossing 2 time	5.047E-10
Eye crossing 2 amplitude	0.246
Average eye rise time	1.486E-10
Average eye fall time	1.494E-10
Eye jitter (rms)	1.132E-11
Eye jitter (pp)	3.991E-11

Eye SNR (signal-to-noise-ratio) is calculated as  $SNR = \text{Amplitude} / (\sigma_{\text{level1}} + \sigma_{\text{level0}})$  and shown in the following figure:

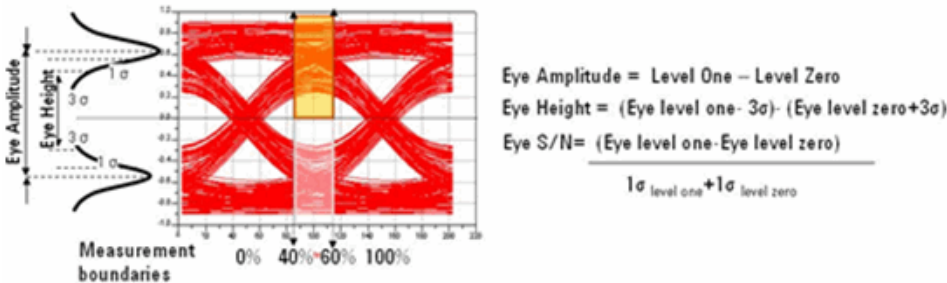

## Saving the FrontPanel



The *Save As FrontPanel Data Display* toolbar icon saves the FrontPanel as a FrontPanel Data Display. The file is saved with a .dds file extension. To open the saved FrontPanel, choose **File > Open** from the Data Display window.



The **Save As Regular Data Display** toolbar icon saves the FrontPanel as a regular data display and does not retain the slider information. The file is saved with a .dds file extension.

# Jitter Analysis FrontPanel

The Jitter Analysis FrontPanel enables easy computation of jitter separation measurements. Many of the Jitter Analysis FrontPanel measurement algorithms are derived from an Agilent Technologies Digital Communication Analyzer, but with simplified implementation.

For information on measurement expressions specific to the Jitter Analysis FrontPanel, refer to the `jitter_separation()` function in the *Measurement Expressions* documentation.

The Jitter Analysis FrontPanel can be accessed from the Data Display window by choosing **Tools > FrontPanel > Jitter Analysis**.

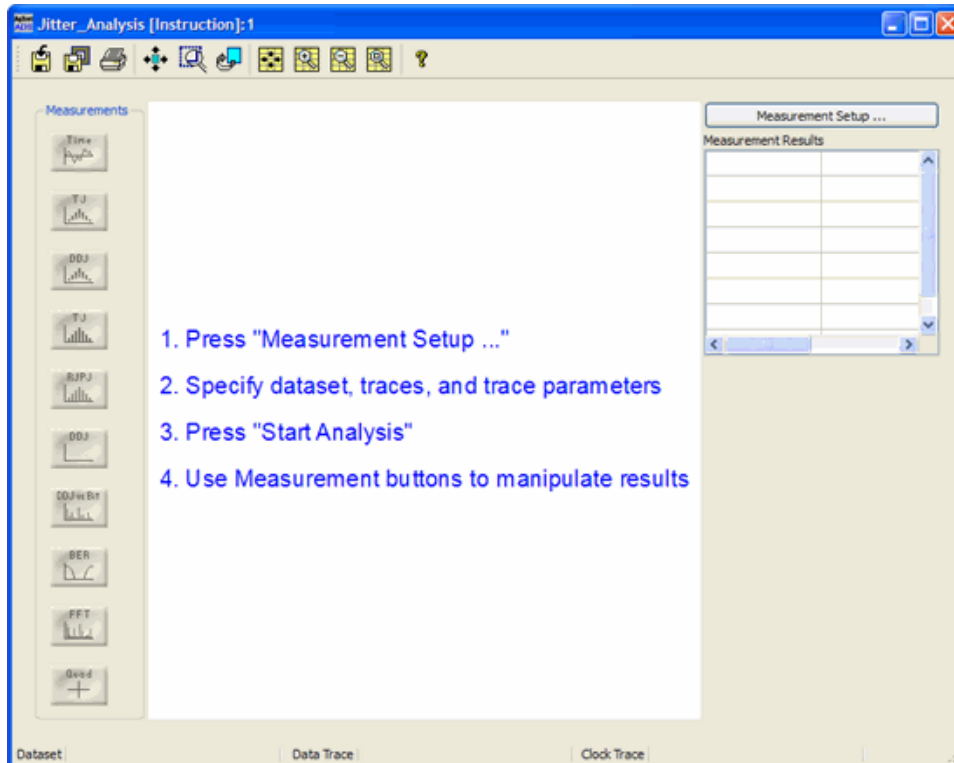

Follow these steps to perform jitter analysis:

1. Open the *Measurement Setup* dialog.
2. Select the Dataset and a suitable Data Trace.
3. Specify the Clock.
4. Select the Input Data Type.
5. Specify the options related to Input Data Type: Pattern Length or ISI Filter Lead/Lag.
6. Set the optional parameters.
7. Perform the analysis.



### Caution

Due to memory limitations, large datasets created for performing jitter analysis can cause instabilities in ADS. This can result in the Data Display window crashing without saving the DDS file. To avoid losing any setup information, save the DDS file before performing a jitter analysis.



### Note

Jitter Analysis generally takes up a lot of memory. It is recommended that you use this feature only on a 64 bit operating system with more than 2 GB RAM.

## Measurement Setup Dialog

From this dialog, you can specify all of the information required to perform a jitter separation measurement. The options available on the dialog change slightly depending on the setting for *Input Data Type* as shown in the following figures:

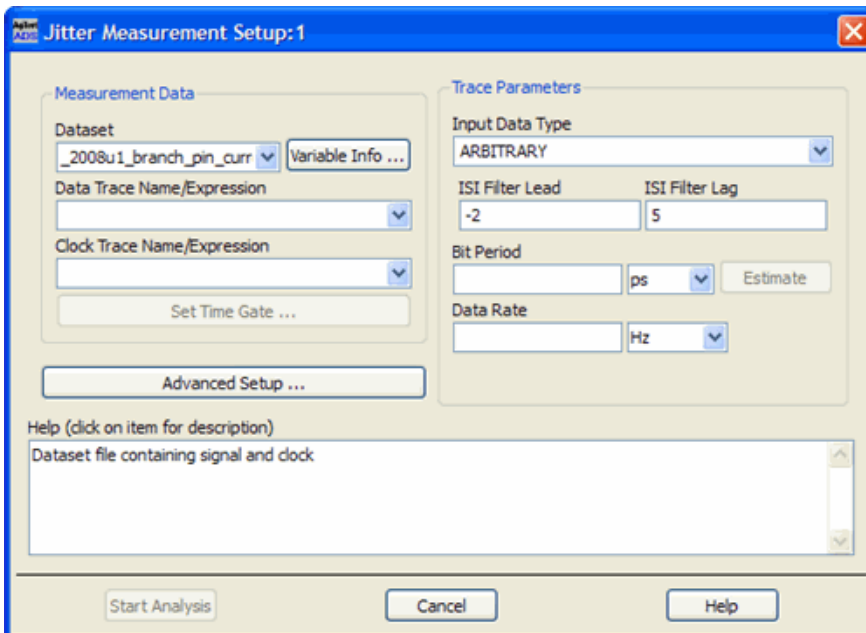
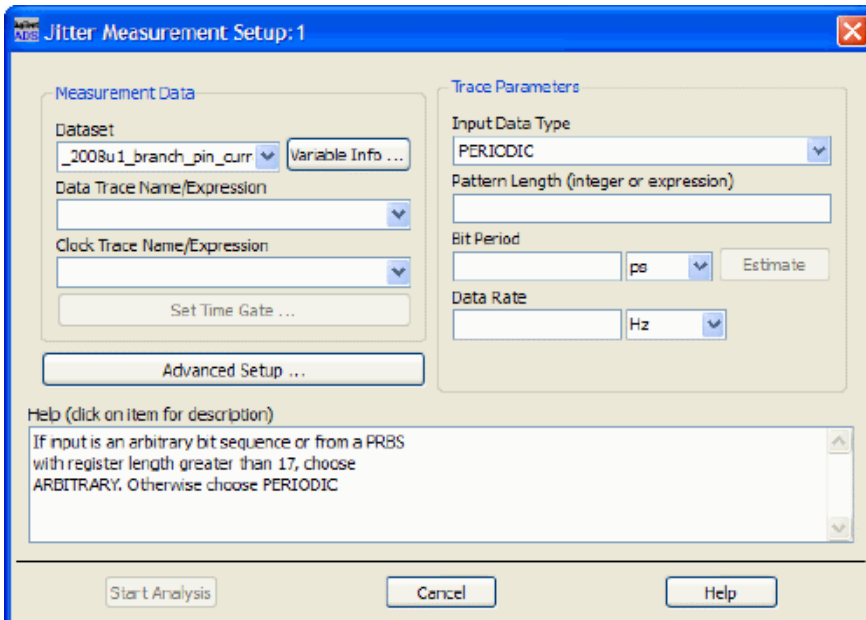

To complete a successful analysis, specify the following:

- **Dataset:** This is the dataset file included in your current workspace that contains, at a minimum, the variable on which the jitter measurement is to be performed. Once this dataset is selected, the **Data Trace Name** and **Clock Trace Name** pull down lists will be populated with the variables contained in the dataset.
- **Data Trace Name/Expression:** This represents the data on which the jitter measurement is to be performed. You may either choose a variable name from the list or enter an expression involving an appropriate variable name. For simplicity, you may select the variable name and then edit the text to arrive at the desired expression.

**Note**

Errors in the expression will not be identified until you try to perform the measurement.

- **Clock Trace Name/Expression or Bit Period:** If the dataset contains a variable that can be used (either alone or in an expression) as the clock for the measurement, this can be specified. Alternately, specifying the Bit Period will enable the analysis routines to determine the clock signal. If the data rate is unknown, click **Estimate** to approximate the period from the Data Trace. Once a bit period has been specified, the corresponding data rate is displayed.
- **Input Data Type:** If the input is an arbitrary bit sequence, or is from a PRBS with a register length greater than 17, choose ARBITRARY. Otherwise, choose PERIODIC.
  - When *Input Data Type* is PERIODIC:
    - **Pattern Length:** This specifies the number of bits which form one period of the measurement pattern. It can either be an integer number or an expression that provides this integer when evaluated.
  - When *Input Data Type* is ARBITRARY:
    - **ISI Filter Lead:** Sets the number of leading coefficients used in the ISI Filter (default = -2).
    - **ISI Filter Lag:** Sets the number of lagging coefficients used in the ISI Filter (default = 5).

**Note**

Clicking on any item on the dialog will change the text in the **Help** box with some simple information regarding the expected entry in that item.

## Specifying a Time Gate

To perform a jitter separation measurement on a subset of the data trace, specify a time gate which will limit the data passed to the jitter analysis. Once a data trace has been specified, clicking **Set Time Gate** displays a plot of the data along with a dialog containing two sliders used to move start and stop markers on the plot. The time corresponding to the marker position will display below the sliders. Once you have selected a suitable window, click **OK** to return to the *Measurement Setup* dialog.

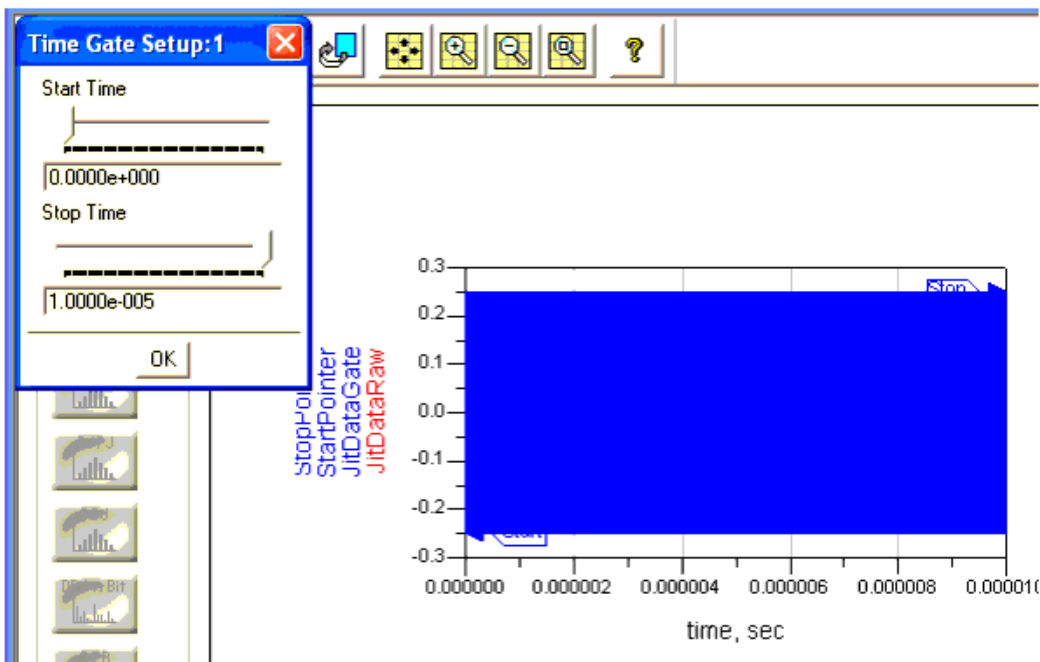

## Specifying Optional Parameters

You can set a variety of optional parameters to improve the performance of the jitter measurement. These parameters may be specified by clicking **Advanced Setup** to display the *Jitter Measurement Advanced Setup* dialog.

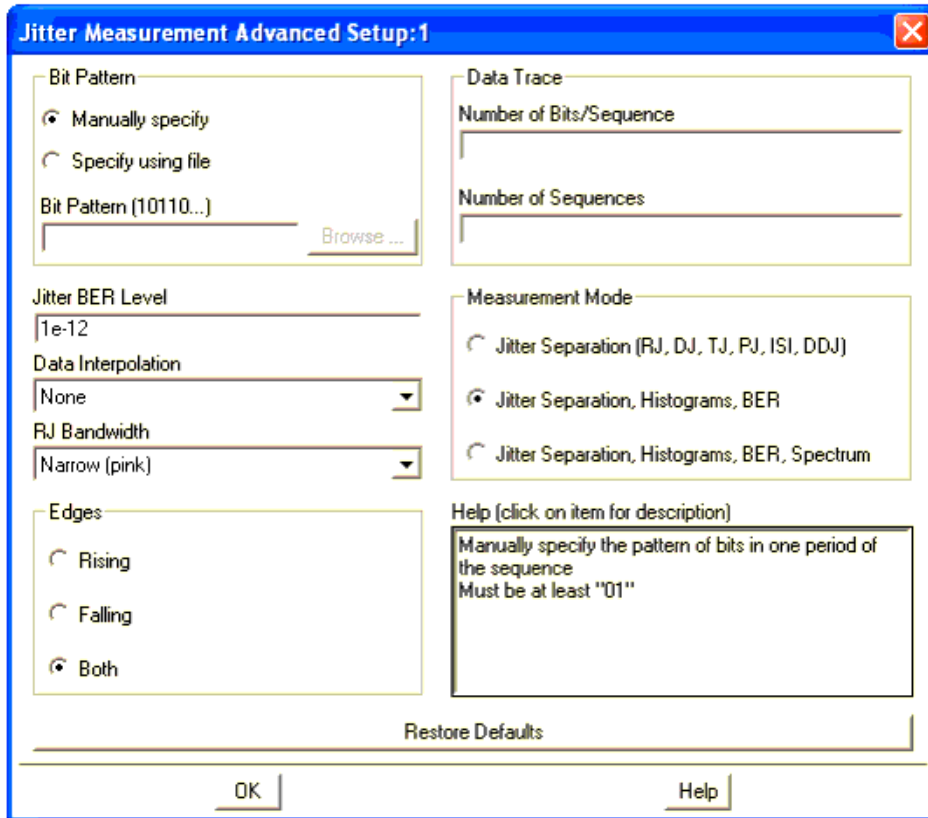

Use this dialog to specify the type of analysis performed by the jitter measurement (Measurement Mode). By default, the Measurement Mode is set to compute the jitter separation as well as provide jitter histograms and bit error rate (BER or Bathtub) results.

If a shorter analysis time is desired, change the mode to provide only the jitter separation results. If the spectrum of the random and period jitter (RJPJ Spectrum) is desired, this can also be specified.

**Note**  
For large datasets, this spectrum computation may require significant computational time.

**Note**  
The plots that will be available after the computation is complete will depend on the Measurement Mode selection.

The Advanced Setup parameters are equivalent to certain command arguments for the `jitter_separation()` function. The table below describes each parameter; for additional information, see the `jitter_separation()` (`expmeas`) function in the *Measurement Expressions* documentation.

Advanced Setup Parameter	Equivalent Command Argument	Notes
Bit Pattern, Manually specify	Pattern	<ul style="list-style-type: none"> <li>Manually specify the pattern of bits in one period of the sequence.</li> <li>Minimum pattern is [0, 1].</li> </ul>
Bit Pattern, Specify using file	Pattern	<ul style="list-style-type: none"> <li>Use a file name to specify the pattern of bits in one period of the sequence.</li> <li>Minimum pattern is [0, 1].</li> </ul>
Bit Pattern	Pattern	The choices are:

Advanced Design System 2011.01 - Data Display

(10110...)		<ul style="list-style-type: none"> <li>• A pattern entered manually, as an array of 0s and 1s (for example: [1,0,0,0,0,0,0,0,1,0]).</li> <li>• A path to a pattern file (use the Browse button to find a path). The pattern bits in the file must be space separated and in a single line.</li> <li>• If no pattern is specified, the pattern is automatically detected from the signal bits. For each sequence of data, the pattern is detected and compared with the previous sequence pattern or the given pattern. If the pattern matches, that particular sequence of data is used.</li> </ul>
Jitter BER Level	BERLevel	<ul style="list-style-type: none"> <li>• The probability level at which to calculate TJ, RJpp in evaluating bit error rate.</li> <li>• Must be between 1e-40 and 1e-1.</li> <li>• Default setting is 1e-12.</li> </ul>
Data Interpolation	InterType	<ul style="list-style-type: none"> <li>• Interpolation to use between points in original data</li> <li>• Choices are None and Linear.</li> <li>• Default setting is None.</li> <li>• For clock-type signals, the DFT is calculated from the uniformly spaced RJ, PJ time record, where each value in the RJ, PJ time record corresponds to a voltage transition in the clock-type waveform. For NRZ data-type signals, the RJ, PJ time record is not comprised of uniformly spaced jitter values. For these signals, the RJ, PJ time record contains "holes" caused by consecutive logical ones or zeros. The lack of information about the jitter at times corresponding to these holes makes it impossible to determine the true RJ, PJ spectrum.</li> </ul>
RJ Bandwidth	RJBWMode	<ul style="list-style-type: none"> <li>• Bandwidth used for computation of random jitter (RJ)</li> <li>• Choices are Narrow (pink) and Wide (white)</li> <li>• Default setting is Narrow (pink)</li> <li>• Jitter analysis uses a spectral technique to separate RJ from PJ. In the RJ, PJ Spectrum the noise floor or baseline depicts RJ. The narrow spikes above RJ depict PJ (see RJ, PJ Spectrum graph). This separation works well for wide bandwidth RJ, having a uniform PSD across the entire jitter spectrum. But in some cases, this is not the norm and the PJ components appear much broader. In such cases PJ can be mis-represented as RJ and this affects the TJ (since TJ is a multiplier of RJ). Setting RJ bandwidth mode to Wide or White treats RJ as flat.</li> </ul>
Edges	EdgeType	<ul style="list-style-type: none"> <li>• Data transition at which jitter is analyzed.</li> <li>• Choose Rising, Falling, or Both.</li> <li>• Default setting is Both.</li> </ul>
Data Trace, Number of Bits/Sequence	Nbps	<ul style="list-style-type: none"> <li>• Number of bits in a sequence or acquisition.</li> <li>• Must be at least the Pattern Length</li> <li>• Nbps is optional and the default is <math>2 * \text{Minimum \# Whole Pattern per sequence} * \text{Nbpp} = 2 * 64 * \text{Nbpp}</math>. (Nbpp is the number of bits per pattern.) In most cases this default value would work, but in some cases this value might need to be set manually since this argument has a direct bearing on the number of serial bits needed for a valid jitter separation and the RJPJ separation method.</li> </ul>
Number of Sequences	NumSeq	<ul style="list-style-type: none"> <li>• Number of sequences in the data.</li> <li>• Must be at least 1.</li> <li>• Can be used to control the amount of data to be used in jitter separation. The default value is (# TIE Points)/Nbps, and in most cases this would work. But if increased control is required over the number of bits to be used, this argument can be set to a different value.</li> </ul>
Measurement Mode, Jitter Separation (RJ, DJ, TJ, PJ, ISI, DDJ)	MeasType	<p>Resulting data:</p> <ul style="list-style-type: none"> <li>• Numeric (single-valued) jitter separation.</li> </ul>
Measurement Mode, Jitter Separation, Histograms, BER	MeasType	<p>Resulting data:</p> <ul style="list-style-type: none"> <li>• Numeric (single-valued) jitter separation.</li> <li>• TJ, DDJ, RJPJ Histograms.</li> <li>• DDJ vs. Bit and BER Bathtub.</li> <li>• This is the default setting for Measurement Mode.</li> </ul>
Measurement Mode, Jitter Separation, Histograms, BER, Spectrum	MeasType	<p>Resulting data:</p> <ul style="list-style-type: none"> <li>• Numeric (single-valued) jitter separation.</li> <li>• TJ, DDJ, RJPJ Histograms.</li> <li>• DDJ vs. Bit and BER Bathtub.</li> </ul>

		<ul style="list-style-type: none"> <li>• RJPJ Spectrum.</li> </ul> <p>Warning: Computation time may be long.</p>
Help (click on item for description)	None	<ul style="list-style-type: none"> <li>• This space is used to display information about the advanced settings.</li> <li>• Click on a setting to see the information in the Help window</li> </ul>

## Performing the Jitter Measurement Computation

Once all of the parameters have been specified, click **Start Analysis** on the *Measurement Setup* dialog to begin the measurement.

**Caution**  
 Due to memory limitations, large datasets created for performing jitter analysis can cause instabilities in ADS. This can result in the Data Display window crashing without saving the DDS file. To avoid losing any setup information, save the DDS file before performing a jitter analysis.

After responding to some default warnings, the FrontPanel will inform you that it is completing the computation. Once the computation is complete, the FrontPanel window will appear with the original data shown and with the jitter separation results displayed as the *Measurement Results*.

**Note**  
 If you do not wish to observe the warning dialogs, select the **Do not show this dialog again** checkbox.

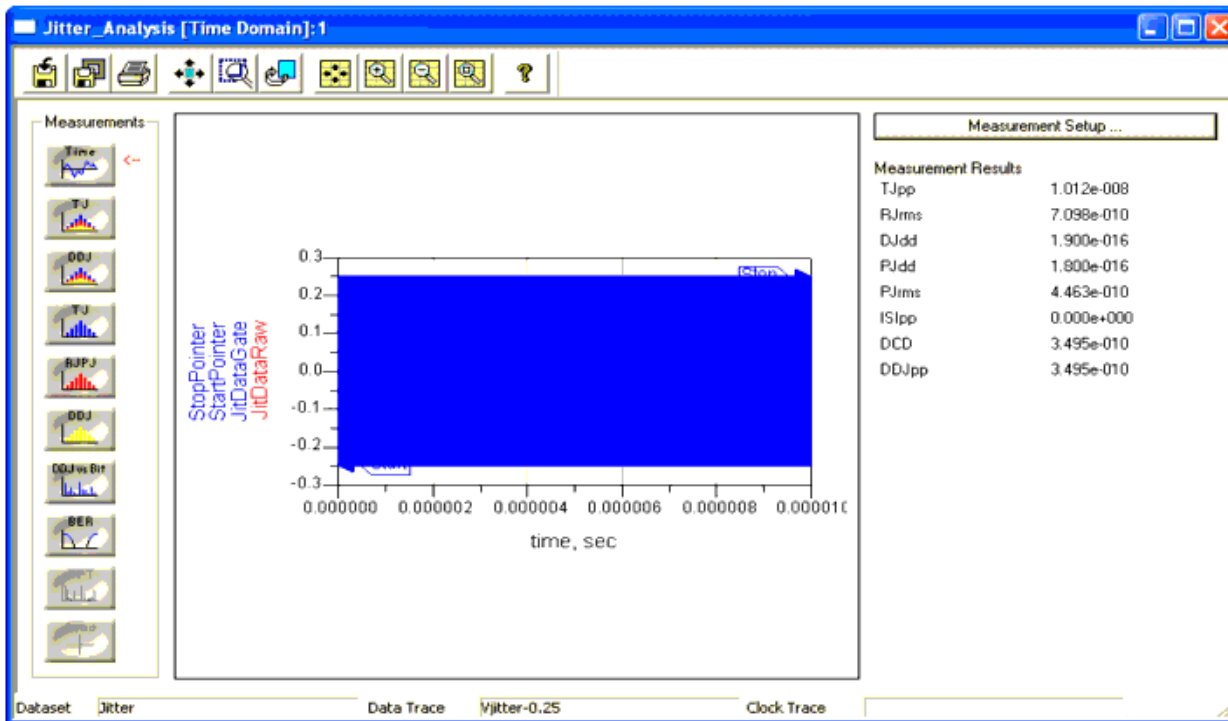

You may now interact with the results of your computation (assuming that you have selected a jitter *Measurement Mode* which generates plots) using the *measurements* buttons on the left.



Clicking **Time** displays the time domain waveform of the original data used in the measurement (both the raw data and the time-gated version if a time gate has been specified).



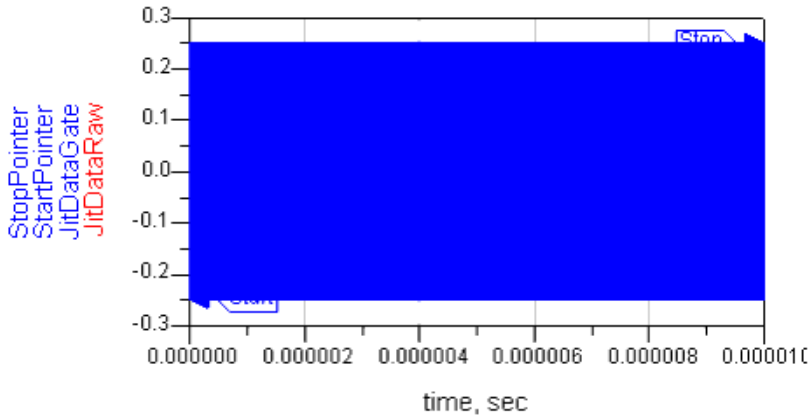

Clicking **TJ** (Total Jitter Composite Histogram) displays histograms of the Total, Random plus Periodic, and Data Dependent Jitter.

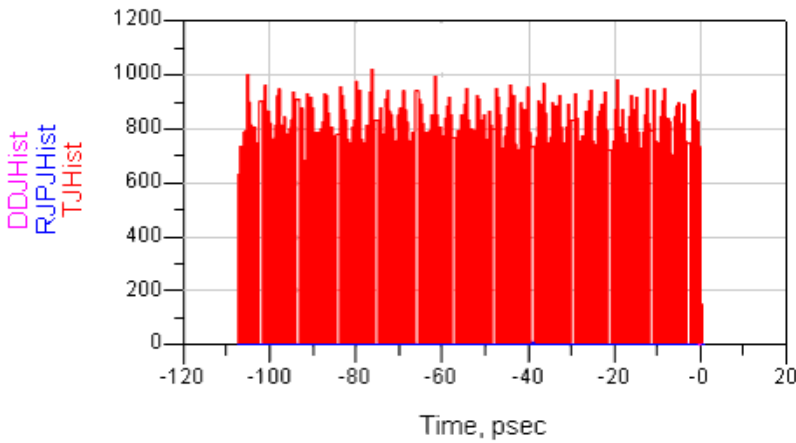

Clicking **DDJ** (Data Dependent Jitter Composite Histogram) displays histograms for data dependent jitter at the rising edge (DDJR), falling edge (DDJF), and both edges (DDJ) if all measurements are available.

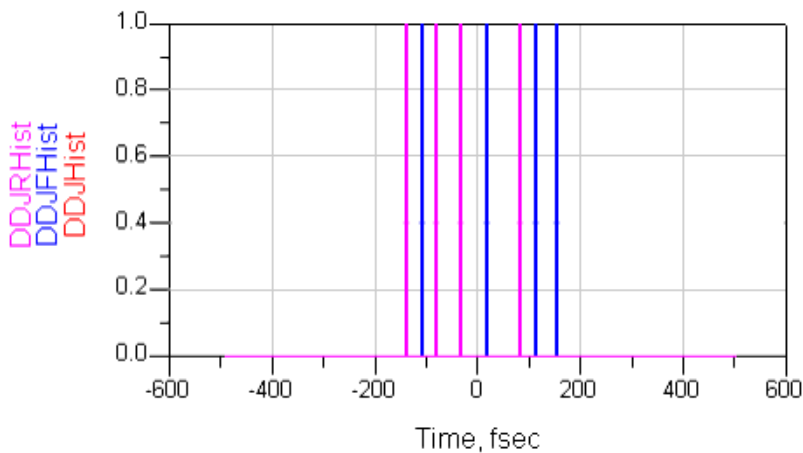

Clicking **TJ** (Total Jitter Histogram) \_\_ button displays the histogram of the total jitter.

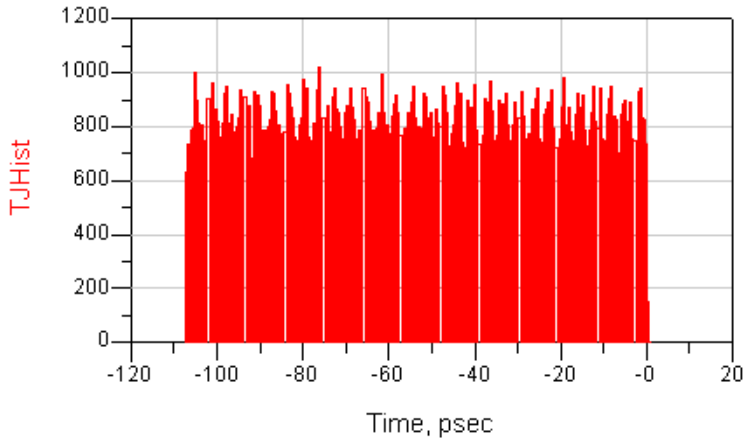

Clicking **RJPJ** (Random and Periodic Jitter Histogram) displays the jitter histogram for the random plus periodic jitter.

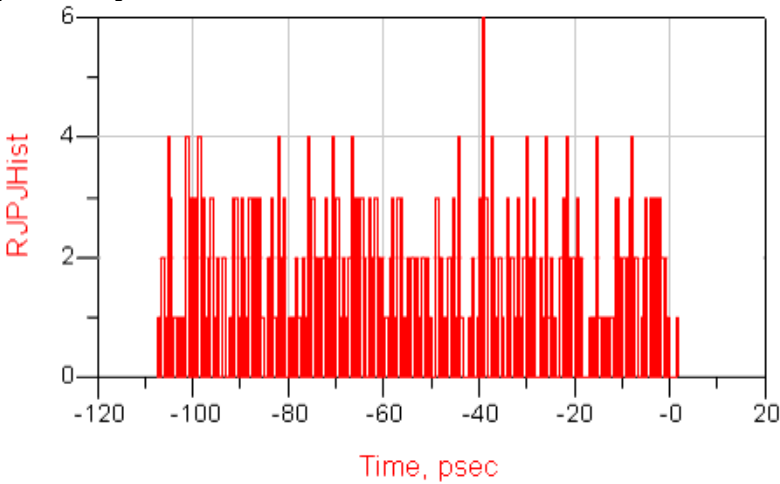

Clicking **DDJ** (Data Dependent Jitter Histogram) displays the histogram for the data dependent jitter.

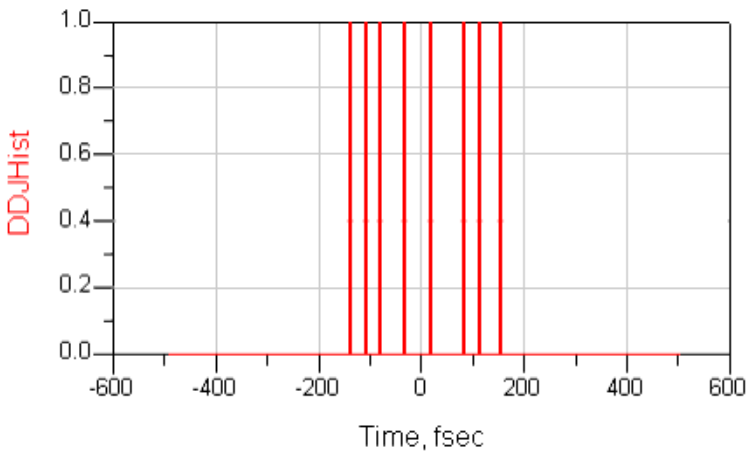

Clicking **DDJ vs Bit** displays the data dependent jitter for each bit index. To limit the range of the bits shown, use the sliders that appear on the window when this plot is active. You may alternately specify the bit index by typing the integer value into the corresponding text box.

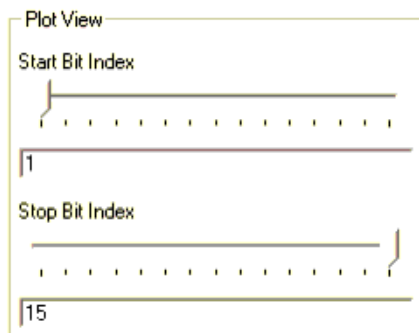
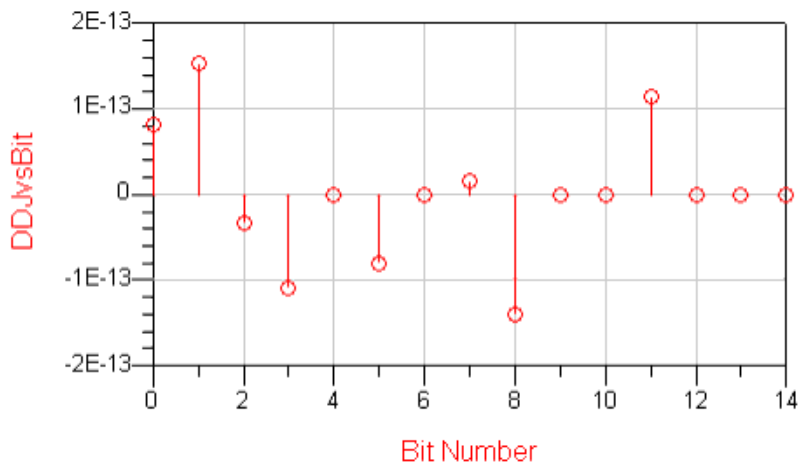

Clicking **BER** displays the bit error rate (bathtub) plot as a function of the fraction of the jitter of the unit interval.

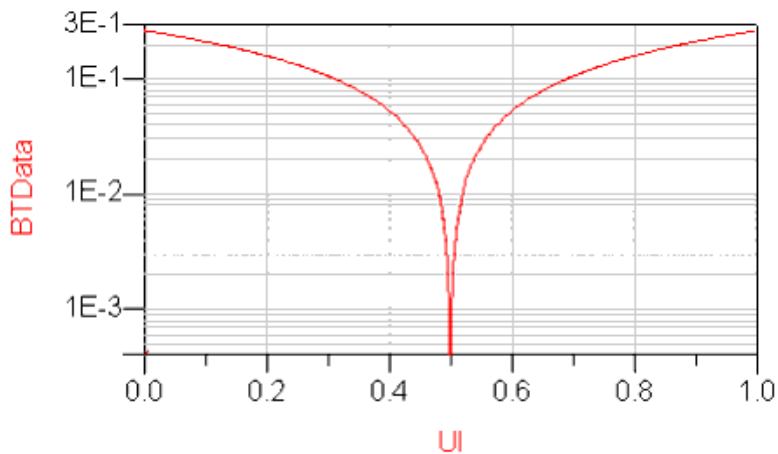

Clicking **Spectrum** displays the frequency spectrum of the random and periodic jitter.

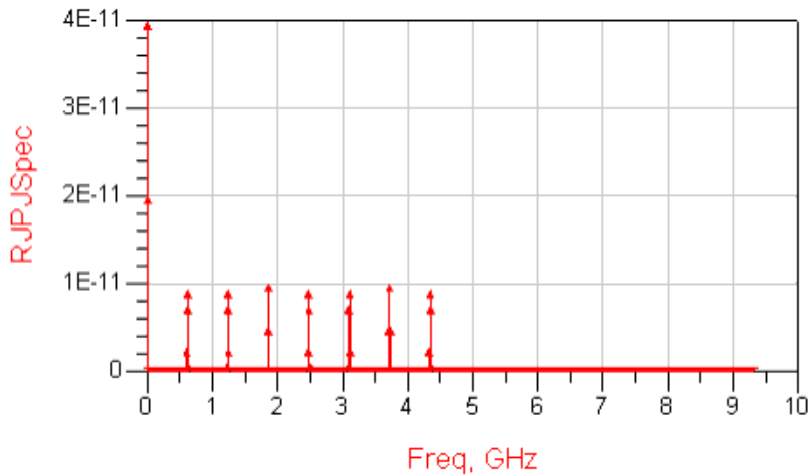

Clicking **Quad** displays the four of the results together: TJ Composite Histogram, DDJ Composite Histogram, BER, and RJPJ Spectrum.

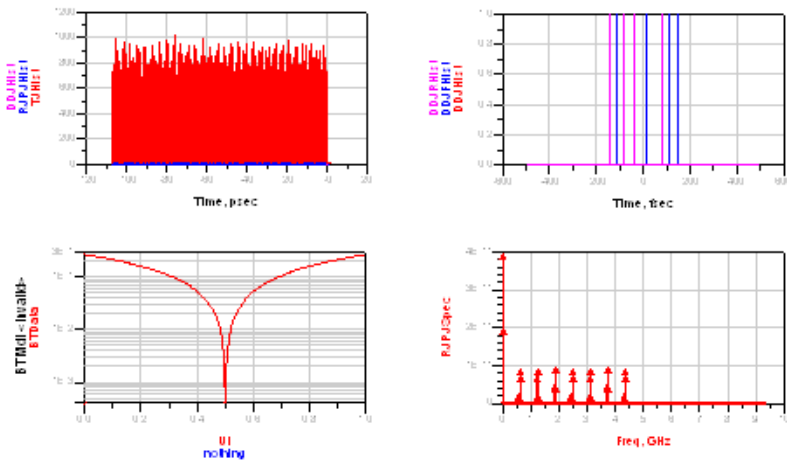

## Saving the FrontPanel



The *Save As FrontPanel Data Display* toolbar icon saves the FrontPanel as a FrontPanel Data Display. The file is saved with a *.dds* file extension. To open the saved FrontPanel, choose **File > Open** from the Data Display window.



The *Save As Regular Data Display* toolbar icon saves the FrontPanel as a regular data display and does not retain the slider information. The file is saved with a *.dds* file extension.

**Caution**  
When you close the FrontPanel, you will lose all of the computed data. This means that when you reopen the file either as a FrontPanel or a regular data display, you will have to wait for the computation to complete.

# Load Pull Front Panel

The Load Pull Front Panel is a data display utility that is specifically for plotting data from measured load pull files (Maury 4.X data). As Maury 4.x Loadpull format is quite flexible, the Loadpull FrontPanel is limited to *Freq* and *Power Sweeps* to produce Loadpull contours. To convert Maury 3.X data format to Maury 4.X see *Converting Maury 3.X format to Maury 4.X format*.

## Note

The Load Pull Front Panel does not directly operate on Maury or Focus load pull files. You have to "format" them, first. For details, see [Converting Maury 3.X Format to Maury 4.X Format](#)

A sample of Maury 4.X data file format acceptable by Loadpull FrontPanel is shown below:

### Maury 4.x Data File

```
! Power sweep plan data file
! Power sweep plan of freq and pin for LDMOS device.
! Date/time Thu Oct 20 10:47:45 2005
```

**Number of Frequencies = 3**

**Number of Variables = 2**

**VAR=<Pin\_avail>, Units=<dBm>**

**VAR=<F0 Load Gamma>, Units=<>**

**! Freq Points per VAR**

```
0.8000 3 29
```

```
0.8500 3 25
```

```
0.9000 3 37
```

**Freq = 0.8000 GHz**

```
num_src_harmonics = 1, num_ld_harmonics = 1
```

```
valid gamma_src1 gamma_ld1 Freq Pin_avail_dBm Pin_deliv_dBm Refl_coef Refl_dB Pout_dBm
```

```
Gt_dB Gp_dB
```

```
<chunk of data for frequency 0.85 Ghz>.....
```

**Freq = 0.8500 GHz**

```
num_src_harmonics = 1, num_ld_harmonics = 1
```

```
valid gamma_src1 gamma_ld1 Freq Pin_avail_dBm Pin_deliv_dBm Refl_coef Refl_dB Pout_dBm
```

```
Gt_dB Gp_dB
```

```
<chunk of data for frequency 0.90 Ghz>.....
```

**Freq = 0.9000 GHz**

```
num_src_harmonics = 1, num_ld_harmonics = 1
```

```
valid gamma_src1 gamma_ld1 Freq Pin_avail_dBm Pin_deliv_dBm Refl_coef Refl_dB Pout_dBm
```

```
Gt_dB Gp_dB
```

```
<chunk of data for frequency 0.8 Ghz>.....
```

In order to successfully read Maury 4.x data file in FrontPanel, the data file must have the keywords defined above in the bold cases as the parser will look for these words in order to successfully parse and read data in ADS Loadpull FrontPanel.

## Starting Loadpull FrontPanel

To start Loadpull FrontPanel from the DDS window choose **Tools > FrontPanel > Loadpull**.

**Figure: Loadpull FrontPanel Window**

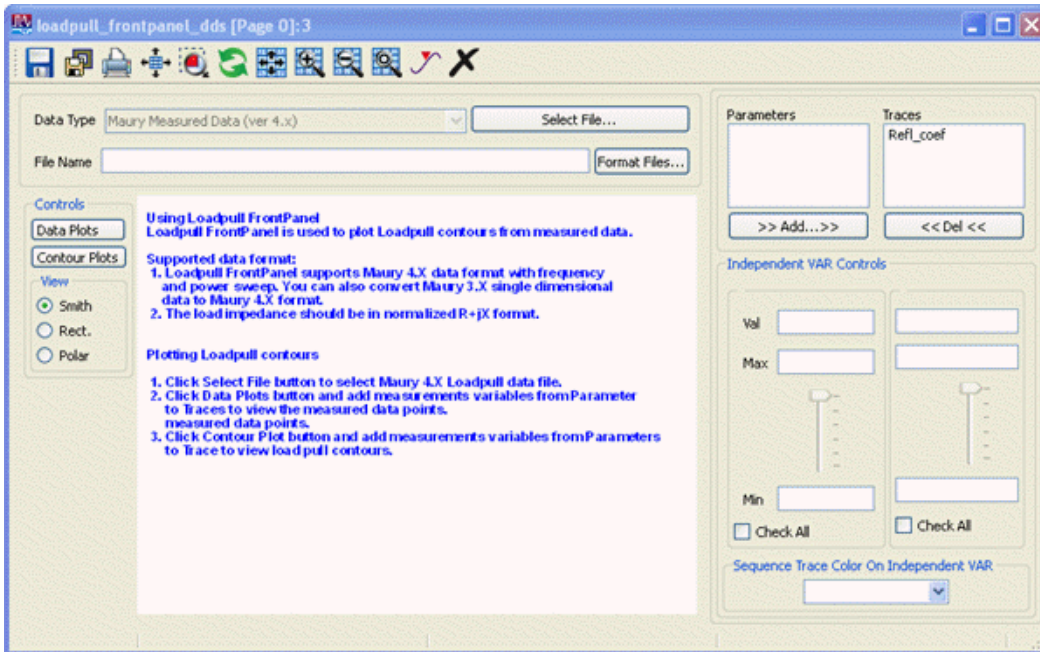

## Reading 4.X Maury Data File with Frequency and Power Sweep

To read Loadpull measured Maury 4.x data file, click the **Select File** button from the Loadpull FrontPanel window and select the Loadpull data file. Once the Loadpull file is read successfully, the measured parameter/variable is displayed under **Parameters**.

Figure: Loadpull file data

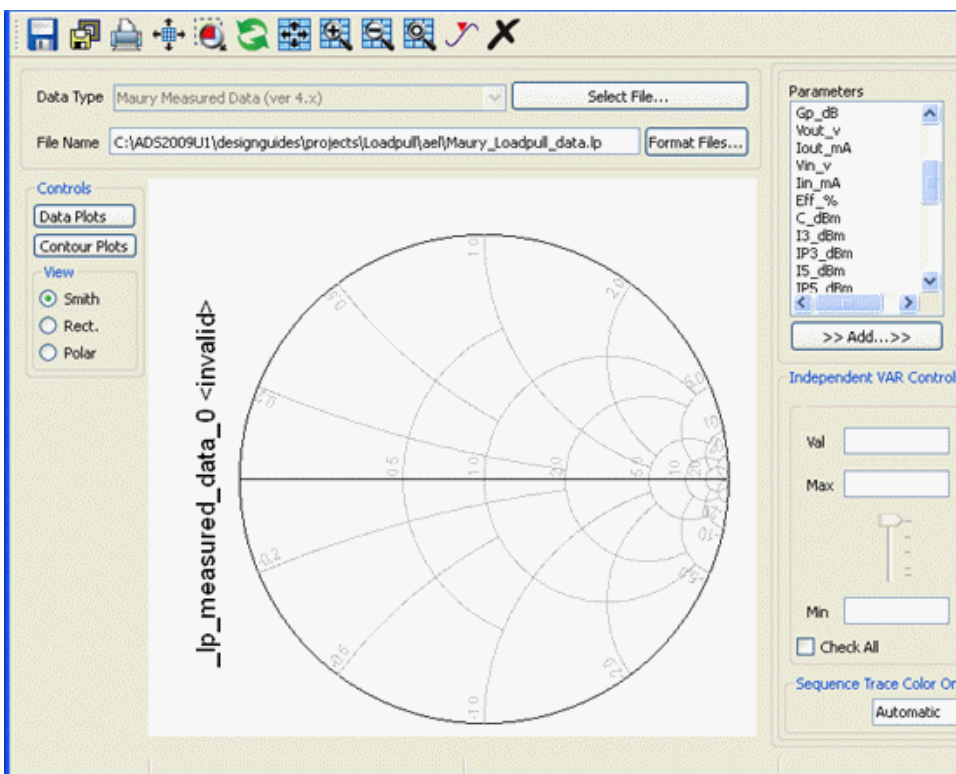

## Plotting measured Data Points

To plot the measured load impedance values on the Smith Chart, click **Data Plots** button in **Loadpull FrontPanel** window. Data Plots is the default selection on starting the Loadpull FrontPanel.

Figure: Data Plots Button

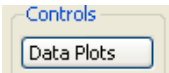

Under **Parameters**, select the measured parameter and click **Add** button to add it to under **Traces**.

Figure: Parameters

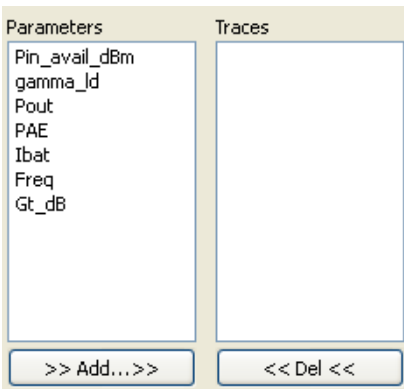

The measured data points gets plotted on the Smith Chart.

Figure: Smith Chart

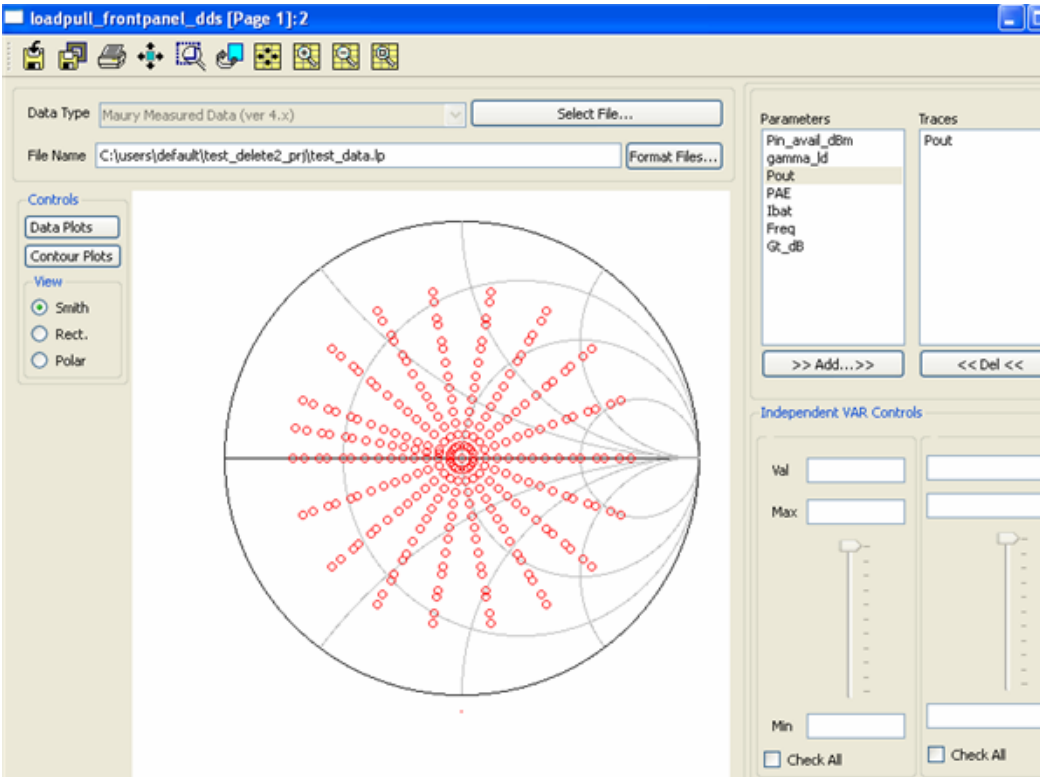

**Loadpull Contours:** To plot the Loadpull contours click **Contour Plots** button in **Loadpull FrontPanel** window.

Figure: Contour Plots Button

## Contour Plots

For the measured variables, for which you want the Loadpull Contours, select the Parameters and click **Add** button to define the *Start*, *Stop*, and *Step* values for the Contour Plots in the pop up window. The window appears with *max* and *min* range of the selected measured variable and you should plot data within the max/min range. If you try to plot Loadpull Contour below or above the default max/min range, the Contours will not appear.

Figure: Define Start, Stop, and Step values

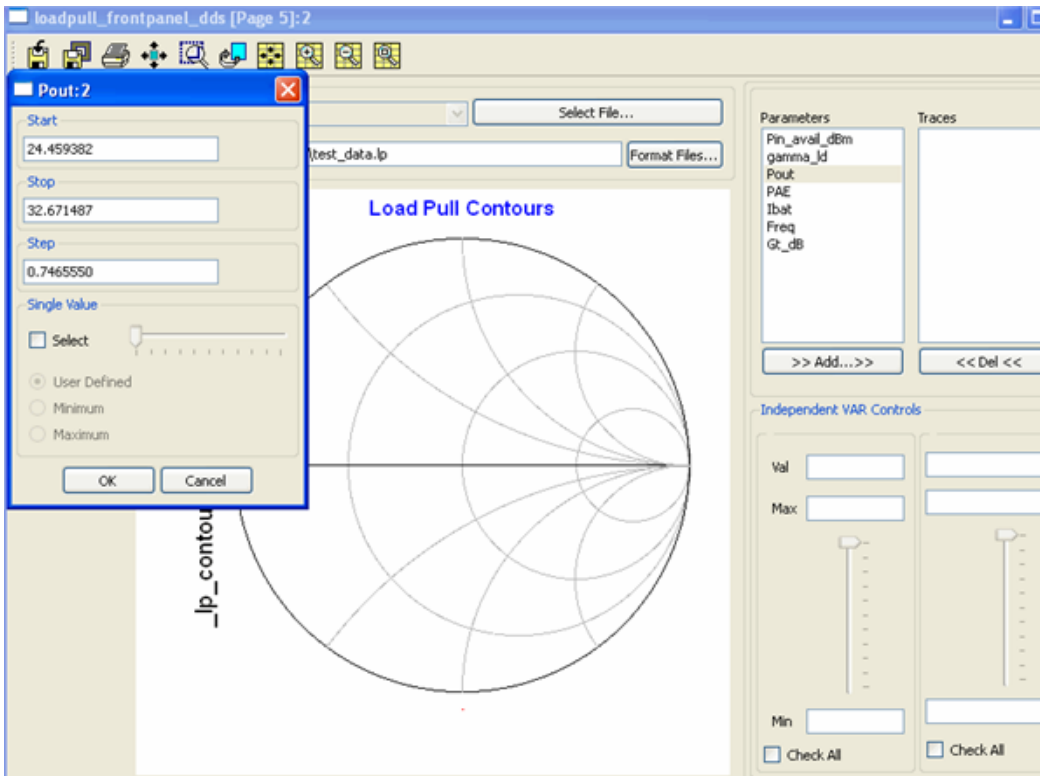

**i** Multiple variables can be added, and same variable can be added multiple times with different data range for Loadpull Contours.



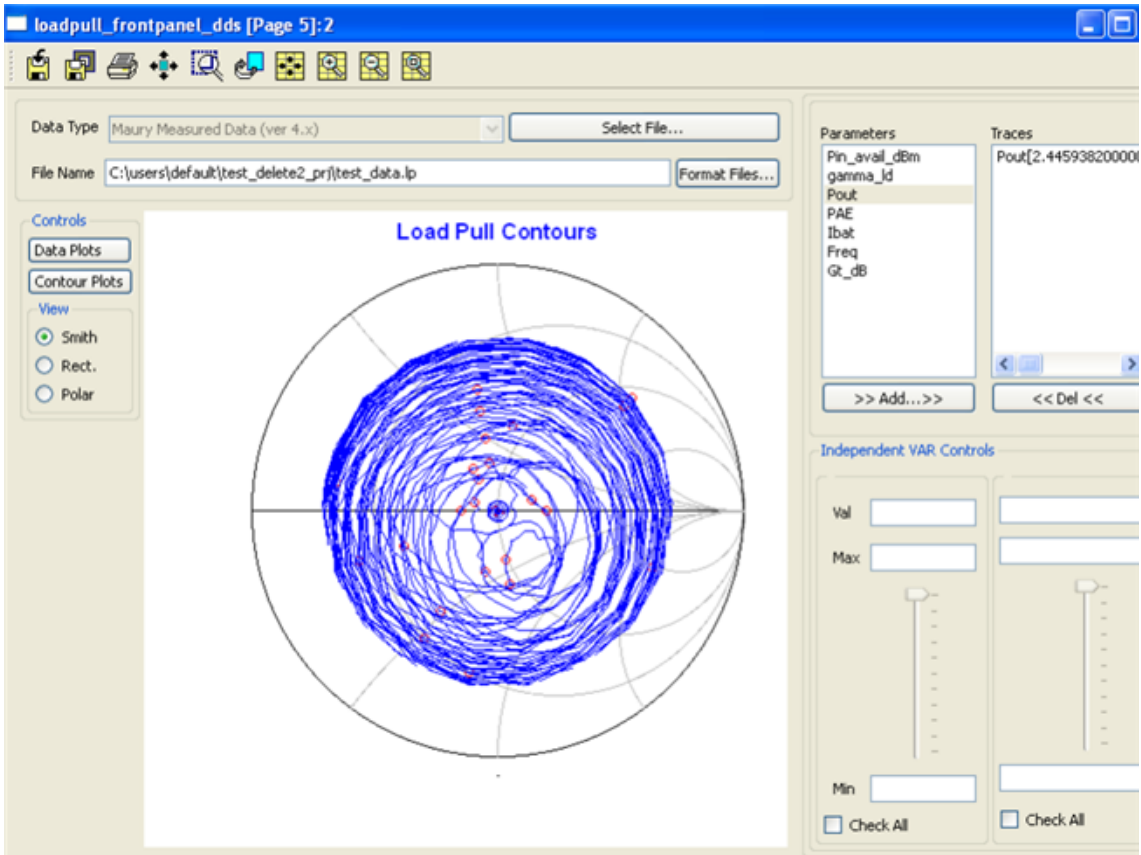

To view Loadpull Contours on **Rectangular** or **Polar** plot, select the required radio button located on left side of **Loadpull FrontPanel** window.

**Figure: View Options**

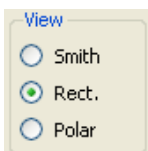

To see the Contours for different power and frequency, activate the slider control by selecting the measurement variable under **Traces**. By default **Check All** checkbox is checked which shows Loadpull Contours for all frequency and power point in your data. To move sliders, uncheck the **Check All** checkbox and use slider control to see Contour for specific frequency and power point.

Parameters

- Pin\_avail\_dBm
- gamma\_id
- Pout
- PAE
- Ibat
- Freq
- Gt\_dB

Traces

- Pout[2.445938200000]
- PAE[1.024655600000]

>> Add...>>      << Del <<

Independent VAR Controls

Freq

Val 2.00e+09

Max 2.00e+09

Min 2.00e+09

Check All

pin\_avail\_dBm

0.0000000

0.0000000

0.0000000

Check All

## Converting Maury 3.X Format to Maury 4.X Format

Perform the following steps to convert Maury 3.X format files to Maury 4.X format:

1. From DDS window, choose **Tools > FrontPanel > LoadPull** to open the Load Pull Front Panel dialog.
2. Click **Select File** to open to Maury 3.X Format file.
3. Click the **Format Files** button to see the Content Browser in the new window.

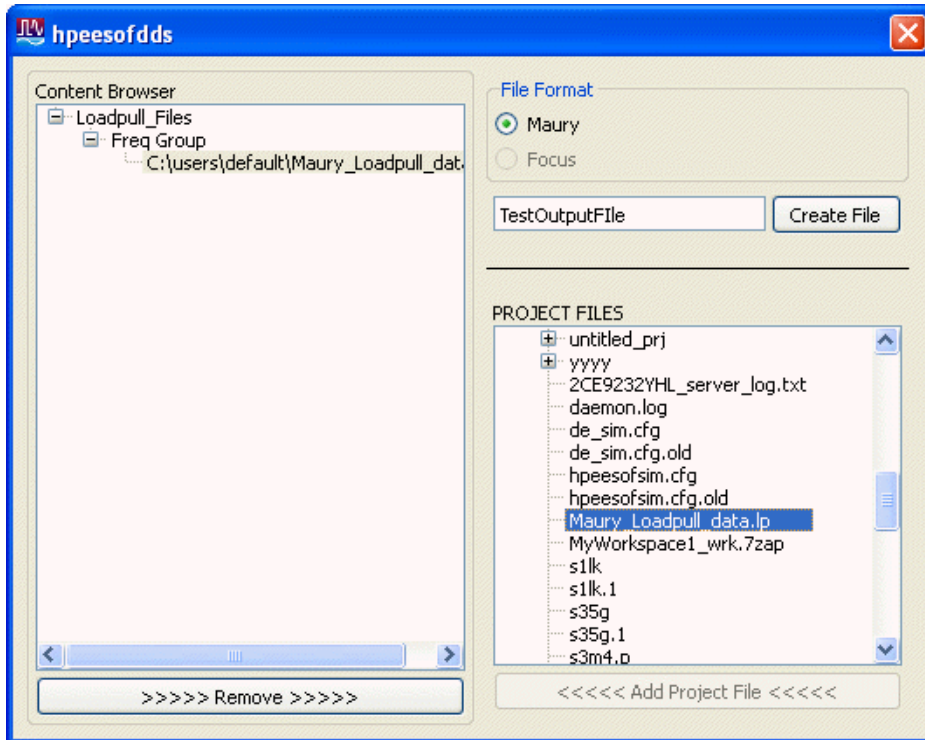

4. Expand the *Loadpull\_Files* Tree under Content Browser and Select *Freq\_Group* node in order to map Maury 3.X files from ADS workspace directory to Content Browser tree. Once the *Freq\_Group* node is selected from the Content Browser, folders from \$HOME directory gets displayed in the Select Loadpull\_Files field.
5. Navigate and select loadpull files and Add Loadpull files to the Freq Group using the Button provided at the bottom of "Select Loadpull File" field. This will add Maury 3.X files from ADS workspace directory to the Freq Group. You can add multiple files representing different power level under one frequency group.
6. To add another frequency group, Select *Loadpull\_Files* node of the tree and add another *Freq\_Group* node. Once the Freq Group is added you can add another set of files representing Loadpull data at a different frequency and varying input power levels.
7. Select *Freq\_Group* under Content Menu in order to map Maury 3.X files from ADS workspace directory to Content Menu. Once the *Freq\_Group* node is selected from the **Content Browser**, folders from \$HOME directory gets displayed in the Selected *Loadpull\_Files* field. Navigate, select, and map Loadpull files.

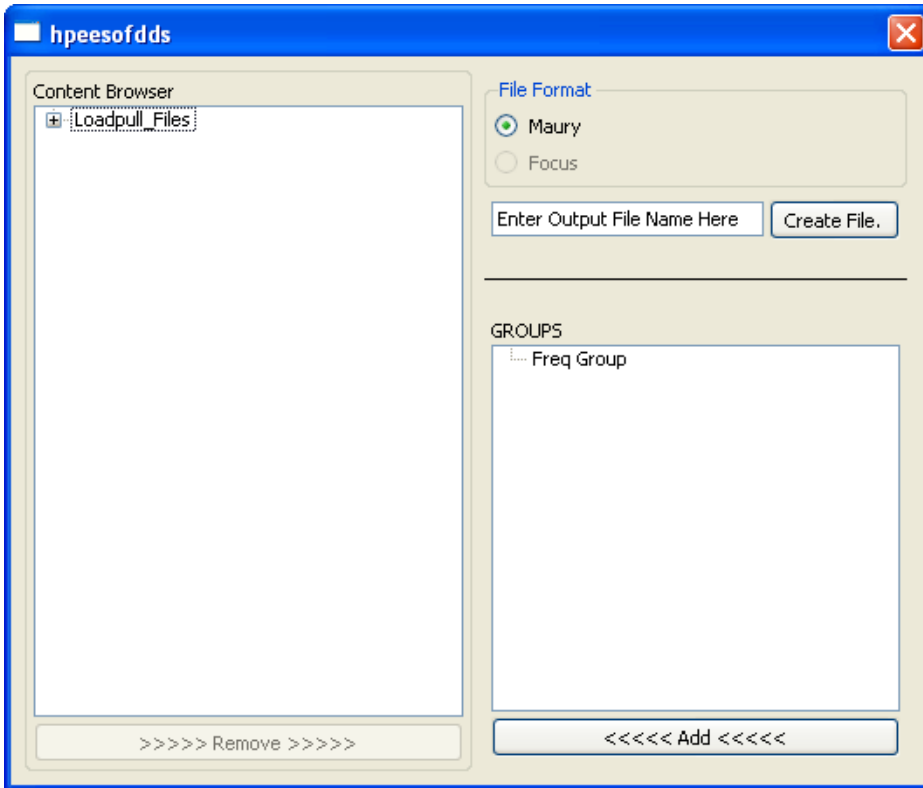

Here the data is mapped into three frequency group and every frequency group has three files for power sweep data ( one file for each power point). The top *Freq\_Group* represents the lowest frequency and the first file in that group represents the lowest power points and so on.

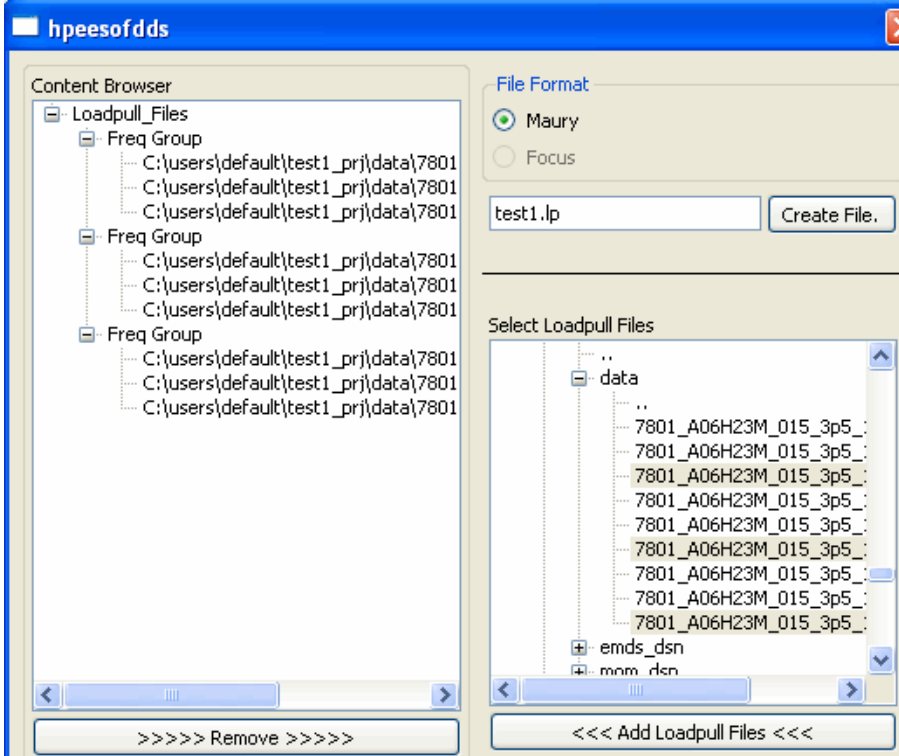

8. Enter a new output file name in the text box and click **Create File** button to save the newly created file.

Once new file is created, you can read this file using **Select File** button and plot Loadpull contours. For slider to read Frequency and *Pin\_avail\_dBm* value properly, the files have this data defined as one of the columns under measured variables. If the measured variable *Freq*, and *Gt\_dB* is not available the file format utility will automatically insert these variable with 0 values in the new file which will be

created. In case frequency and power sweep data is not available, the utility can also take single file in Maury 3.X format and convert it to Maury 4.X format.

# S-Parameter TDR FrontPanel

The Scattering Parameter Time-Domain Reflectometer FrontPanel (S-Parameter TDR or SP TDR) enables time-domain reflectometry analysis to be performed when starting with frequency-domain input S-parameter datasets. Many standard time-domain TDR signal processing techniques, including such operations as: time-domain gating, frequency-domain windowing, layer peeling, and ideal port extensions are available in the SP TDR FrontPanel.

For information on measurement expressions specific to the S-Parameter TDR FrontPanel, see *FrontPanel S-Parameter TDR Functions (expmeas)* in *Measurement Expressions (expmeas)*.

The S-Parameter TDR FrontPanel can be accessed from the Data Display window.

- To access the S-Parameter TDR FrontPanel from the Data Display window, choose **Tools > FrontPanel > SP TDR**.

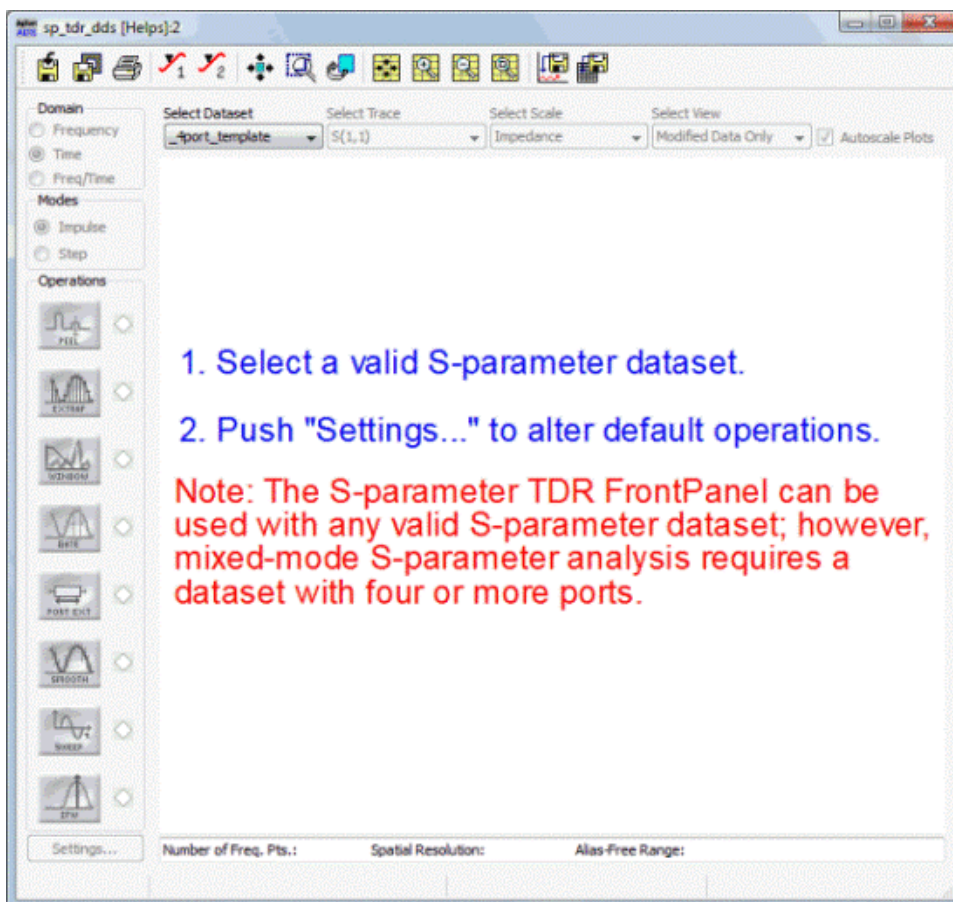

## Overview

The following steps provide a quick overview to start a TDR analysis:

1. Select a valid S-parameter dataset from the Select Dataset dropdown list. (See Note 1)
2. Select the desired trace. This is often S(1,1) for TDR analysis and S(2,1) for TDT analysis.
3. Choose the desired domain to view: frequency, time, or both (Freq/Time).
4. Enable TDR operations in one of two ways:
  - From default parameters directly in the SP TDR main window, or
  - From the Settings dialog box.
5. Set/Enable the optional parameters for TDR operations specific to your dataset.
6. Examine results in the SP TDR main window.

**Note**  
S-parameter datasets should not have any swept variable other than frequency

**Caution**  
Due to memory limitations, large datasets created for performing S-Parameter TDR analysis can cause instabilities or long delays in ADS when certain operations are enabled. This can result in the Data Display window crashing without saving the DDS file. To avoid losing any setup information, save the DDS file before performing a TDR analysis.

## TDR FrontPanel Operations

Input S-parameter datasets pass through various operating blocks based on which operations have been enabled in the Systems dialog or SP TDR main window. Consider each TDR operation or transform as a specific block that represents the flow of data from input to output; then, a system-level diagram of the SP TDR FrontPanel would look like the following:

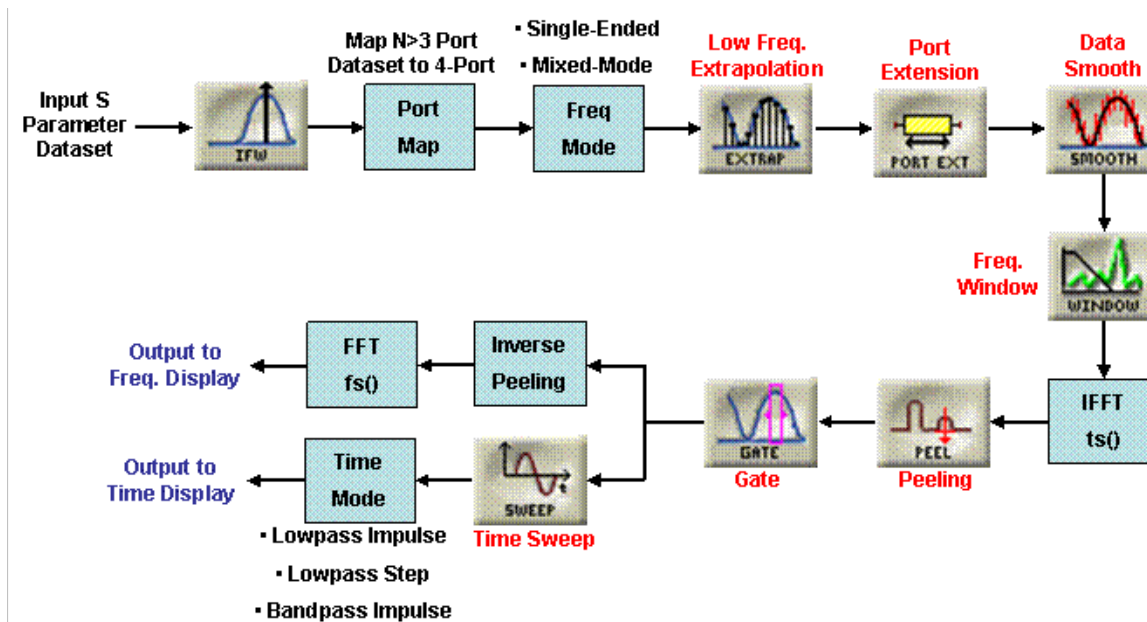

Operating blocks that are not enabled specifically from within the SP TDR are "short-circuited" or "off". Details of each of the system operation blocks and how their parameters are manipulated within the SP TDR FrontPanel can be found later in the documentation. A synopsis of each of the blocks is presented here:

### Frequency Domain Operations

- [Port Mapping](#) - Convert an S-parameter dataset with more than three ports to a 4-port dataset.
- [Frequency Mode](#) - Select between single-ended or mixed-mode stimuli, including: differential-out differential-in, common-out common-in, differential-out common-in, common-out differential-in. Mixed-modes are only available with 4-port datasets.
- [Low Frequency Extrapolation](#) - Lowpass Time Modes are only available for datasets with data down to zero frequency. For datasets that are missing these data point, Low Frequency Extrapolation can be used to enable Lowpass Time Modes.
- [Smooth](#) - Performs smoothing operations on noisy frequency-domain data.
- [Port Extension](#) - Add a virtual length of ideal or lossy transmission line to any of the data ports.
- [Window](#) - Performs a frequency-domain window on the data to minimize ringing in the time-domain traces.
- IFFT - Performs an inverse Fourier transform on the data using the DDS  $ts()$  (expmeas) function.

### Time Domain Operations

- [Impulse File Writer](#) - Converts input frequency-domain data into causal time-domain impulse responses.
- [Peeling](#) - Removes the impedance masking effects of having multiple discontinuities in the device under test (DUT).
- [Gate](#) - Time domain removal of impedance sections.
- Inverse Peeling - Undo the Peeling algorithm prior to displaying in the frequency domain.
- FFT - Performs a Fourier transform on the data using the DDS  $fs()$  (expmeas) function.
- [Time Sweep](#) - Set the maximum and step time values for viewing time domain data.
- [Time Mode](#) - Choose how the time domain is viewed: Lowpass Impulse, Lowpass Step, or Bandpass Impulse.

## Enabling TDR FrontPanel Operations

Each of the operations defined above is either always enabled (e.g. FFT/IFFT) or settable within the SP TDR itself. Each settable operation block can be enabled either directly from the SP TDR FrontPanel main window or via the Settings dialog box. For example, the Peeling algorithm is enabled by clicking the associated button on the main window (the light will turn on) which will in turn check the corresponding box in the Settings dialog box or vice-versa.

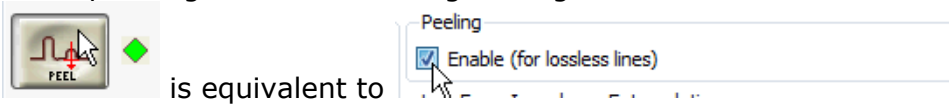

Only the eight operations that appear as buttons on the main window are possible to enable/disable in addition to port mapping which must be enabled from the Settings dialog. All other system blocks are always "on" though specific parameters pertaining to each can be set within the Settings dialog box. "Raw" data when viewed in the SP TDR main window only passes through those operation blocks that are always "on" or which change the bandwidth of the selected dataset.

## S-Parameter TDR FrontPanel Utilities

In addition to operating blocks on the input data, the S-Parameter TDR FrontPanel is equipped with multiple utilities to make manipulation of datasets easier. These utilities include:

- The [Data File Utility](#) a read/write tool for Touchstone or Citifile formats.
  - The [Data Editor Tool](#) an S-parameter spreadsheet for direct data manipulation.
  - Ability to [save the SP TDR FrontPanel state as a regular Data Display window](#) for advanced manipulation.
- Each of the utilities are accessed via the SP TDR main window toolbar.

### Data File Utility

The SP TDR FrontPanel Data File Tool is a simple utility to import and export datasets of different formats.



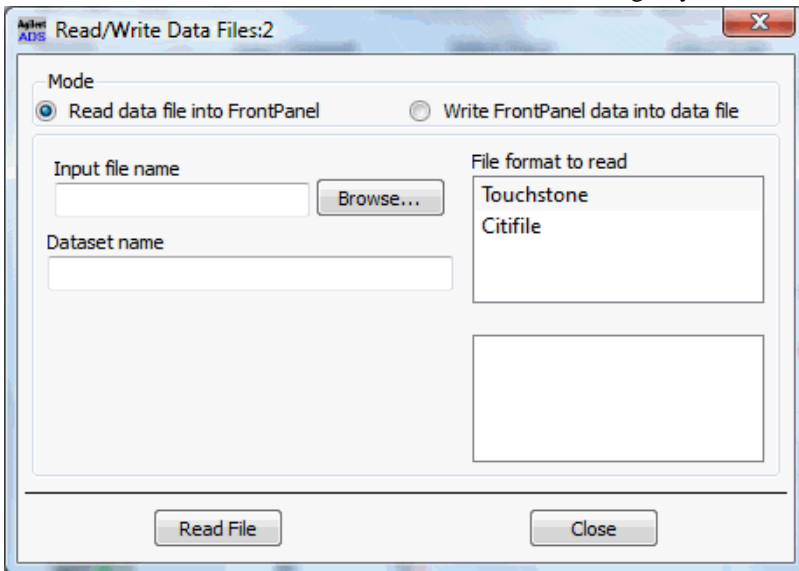

- **Read** data file into FrontPanel- the Read option takes a file of Touchstone or Citifile format as input and converts it into the dataset format useable by ADS Data Displays. A file will be created with the ".ds" extension which will then be used to populate the SP TDR FrontPanel itself.
- **Write** FrontPanel data into data file- the Write option takes the modified frequency-domain data from the SP TDR and writes it to a Touchstone, Citifile, or dataset file.

## Data Editor Tool

The S-Parameter TDR FrontPanel Data Editor Tool is a spreadsheet-based utility used for editing individual ports and data points within a dataset. The Data Editor Tool can be opened from the TDR FrontPanel main window toolbar.

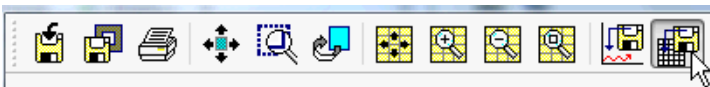

### Caution

A large number of ports or data point can cause instability on running the Data Editor Tool for the first time. This can result in the Data Display window crashing without saving the DDS file. To avoid loss off setup information, save the Data Display file before opening the Data Editor Tool.

After population of the spreadsheet from the selected dataset, the Data Editor Tool appears.

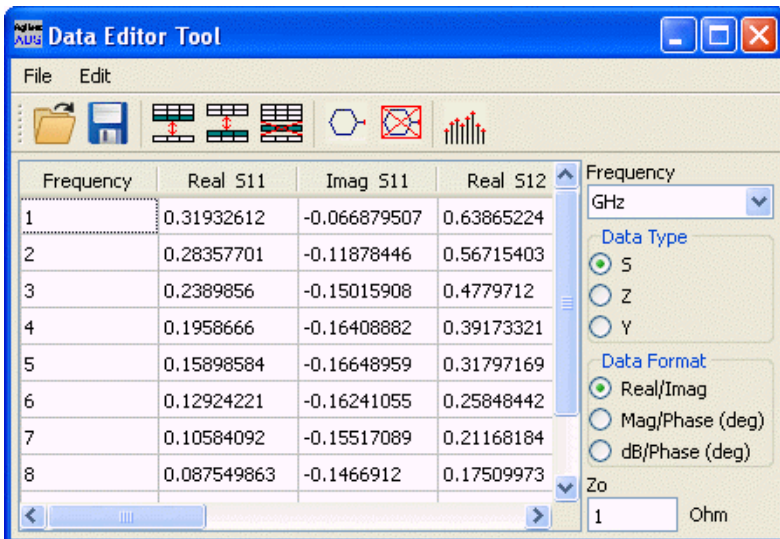

Various data manipulation possibilities are available with the Data Editor Tool. Conversions between S, Z, and Y parameters can be done using the tools along the side of the Data Editor Tool.

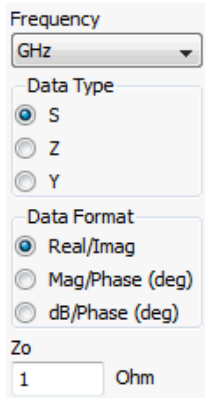

Additionally, the data format can be converted between Real/Imag, Mag/Phase, and dB/Phase. Parameters specific to the dataset such as fundamental frequency base and characteristic impedance can also be set here. Editing the data can be performed directly within the spreadsheet table cells or via the toolbar buttons along the top of the Data Editor Tool.



The functions perform operations such as: adding or removing ports, inserting or deleting rows, and resampling the data to produce equally spaced frequency samples. In order to clear all data use the menu function **Edit > Clear All**.

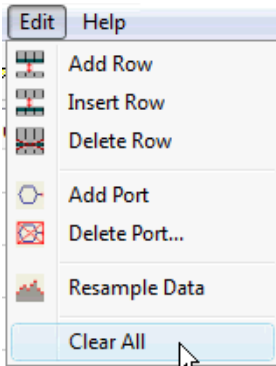

The Open and Save toolbar button allows any dataset, Touchstone, or Citifile to be used within, or exported from, the Data Editor Tool.

## Viewing TDR FrontPanel as Regular Data Display Window

In order to save the SP TDR workspace as a regular Data Display, and thereby allowing all the functionality of that type of window, choose **Save As Regular Data Display** from the SP TDR toolbar. After saving, close the current SP TDR window, and then open the saved ".dds" file from a regular Data Display window.

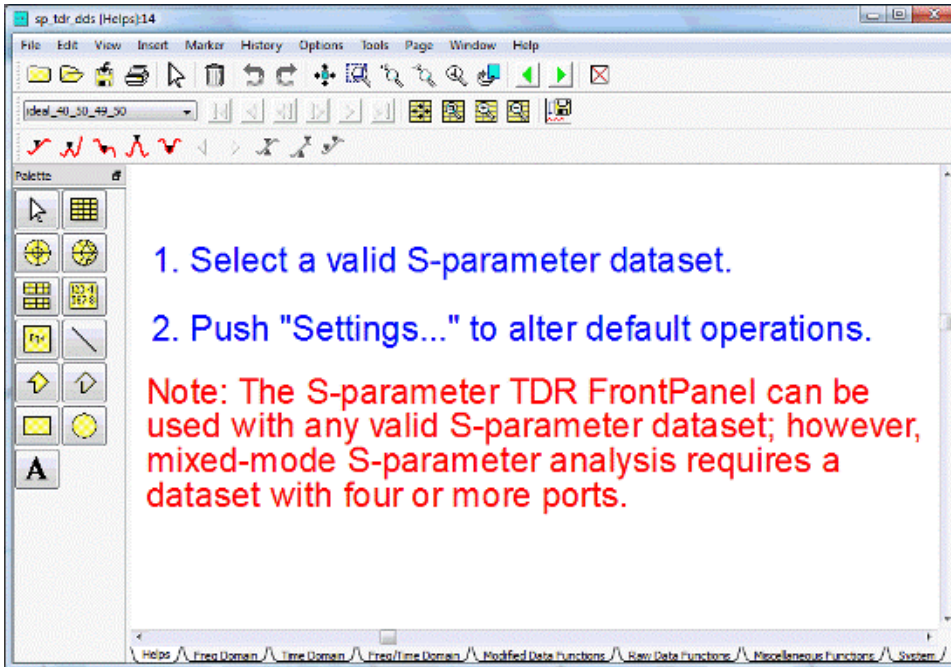

Viewing the TDR in a Data Display window allows behind-the-scenes manipulation of SP TDR data. For example, the fixed order of operations for the SP TDR data can be altered by changing the order in which functions are called in the Data Display. The following is a brief description of each page in the TDR Data Display:

1. Help Page - The welcome page for the SP TDR FrontPanel.
2. Freq Domain Page - Contains a single plot for Modified, Raw, and Window frequency-domain traces.
3. Time Domain Page - Contains a single plot with Modified, Raw, and Gate time-domain traces.
4. Freq/Time Domain Page - Contains both the frequency- and time-domain plots and corresponding traces.
5. Modified Data Functions Page - This is the central page containing all operations ranging from Port Mapping to Frequency Scaling. Changing the order of these functions will alter TDR results.
6. Raw Data Functions Page - Operation functions that Raw data passes through.
7. Miscellaneous Functions Page - Used internally by the SP TDR FrontPanel.
8. System Page - Contains nine plots showing traces at the output of each operation box of interest.

#### **Caution**

Manipulating TDR FrontPanel equations directly from the Data Display window is for advanced users with knowledge of the Data Display environment and data structures. Altering the order or parameters of the TDR functions can produce unexpected results.

## TDR FrontPanel Functionality

The following sections will walk through the basic operations and functionality of the SP TDR FrontPanel. The walkthrough starts with a specific ADS S-parameter simulation and corresponding dataset. This dataset can be simulated manually or downloaded [here](#). The walkthrough will then give examples for most of the SP TDR operations using this dataset as input. More detailed explanations and examples are also available within some of the following sections.

### Example S-Parameter Simulation

The example in the following sections will use a dataset generated from the ADS schematic window. This simulation setup represents a DUT with multiple ideal transmission line sections of varying impedance values. The impedance sections will be 40 Ohm, 50 Ohm, 49 Ohm, and a final 50 Ohm length of ideal line and with 50 Ohm terminations. All lengths of line are lossless. Realistically the

impedance discontinuities of a DUT would be unknown; however, generating the [dataset](#) in this manner will be beneficial for examining the various operations of the FrontPanel TDR.

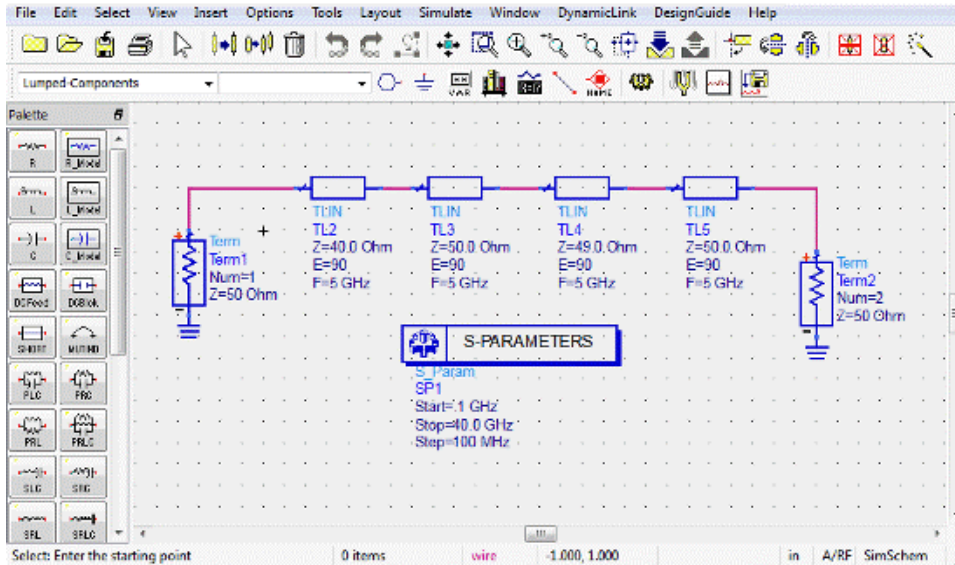

After creating the above schematic in ADS, run the simulator in order to create the S-parameter [dataset](#). For this example the dataset, and hence the schematic, are named "ideal\_40\_50\_49\_50" - the numbers correspond to the impedance sections of the line. Notice that the start frequency of the simulation component was intentionally set equal to the step frequency (and not 0 Hz). This is done for a later example of Low Frequency Extrapolation.

After simulating the schematic open the S-Parameter TDR FrontPanel from a Data Display window as described in [S-Parameter TDR FrontPanel](#). Select the "ideal\_40\_50\_49\_50" dataset from the **Select Dataset** list in the SP TDR main window. If this is the first dataset selected after opening the FrontPanel then the SP TDR will automatically precondition the data such that the impedance profile can be viewed. However, for purposes of this tutorial and to understand the operations involved, manipulate the SP TDR so that it looks like the following with frequency domain chosen, impulse mode, and no operations enabled:

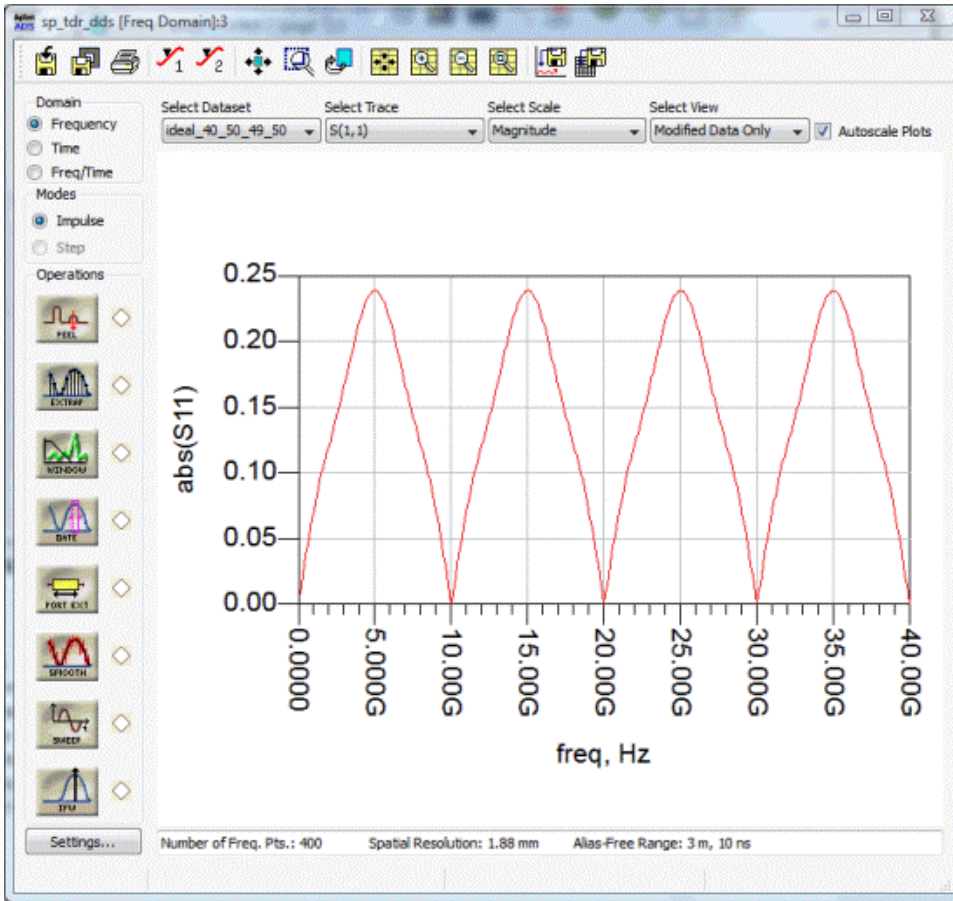

## Status Panel

Along the bottom of the main window is the status panel which displays various non-settable values regarding the dataset: Number of Frequency Points, Spatial Resolution, and the Alias-Free Range. In the TDR, these values are defined as:

$$\text{Spatial Resolution} = \frac{c \Delta t}{2\sqrt{\epsilon}}$$

$$\text{Alias - Free Range} = \frac{t_{max}}{\sqrt{\epsilon}}$$

$$\text{Velocity} = \frac{3e8}{\sqrt{\epsilon}}$$

## Global Parameters

The distance calculated in the TDR is a function of the relative velocity of propagation. The velocity of propagation can be defined either in terms of meters/sec, or in terms of the effective relative dielectric permittivity. The relative dielectric permittivity can be set in the Settings dialog box. This area in Settings is also used to set the characteristic impedance and time domain x-axis values.

Global Parameters

Time Axis:

Velocity:

Z0 (Zdiff/2):  Ohms

Dropdown lists at the top of the SP TDR FrontPanel main window manipulate various parts of the

dataset:

- **Select Dataset:** Choose any valid S-parameter dataset in the current working workspace. For this example, choose the "ideal\_40\_50\_49\_50" dataset.
- **Select Trace:** SP TDR operations can be performed on any of the S-parameters. Typically  $S(1,1)$  is used for TDR analysis and  $S(2,1)$  for TDT analysis.
- **Select Scale:** In the frequency domain the scale values are: dB, Magnitude, Phase, Real, and Imag. In the time domain the scale values become: S-Parameter Coefficient ( $\rho$ ), Impedance, or Volts. If the Domain viewed is Freq/Time then the Scale is not selectable and the current Scales will be used.
- **Select View:** Any combination of the original data or the data modified by the SP TDR may be Viewed.

The remainder of this example will alternate between the main SP TDR window and the Settings dialog box. Open this dialog by clicking the **Settings** button.

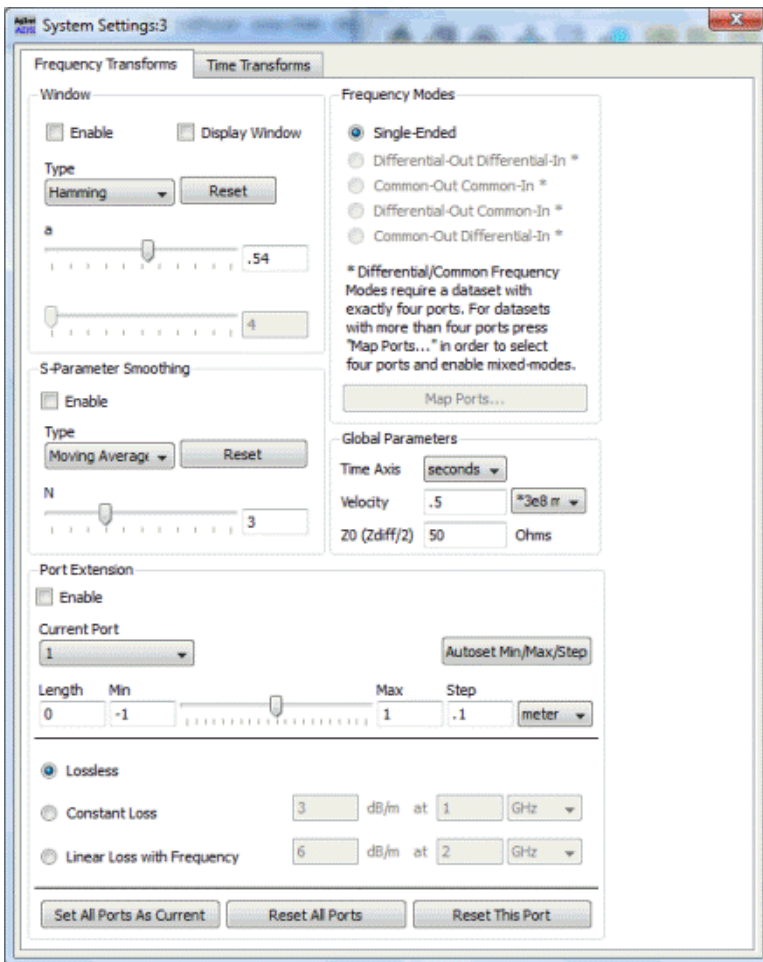

## Port Extension

The Port Extension operation will add a virtual length of ideal, lossless, or lossy transmission line to any of the input ports of the dataset. This is useful for noncausal data or for simple masking extraction. For the "ideal\_40\_50\_49\_50", notice that a reflection occurs at time  $t=0$  which results in noncausal effects at time  $t=10$  ns. To overcome this problem first enable **Port Extensions** in the Settings dialog box.

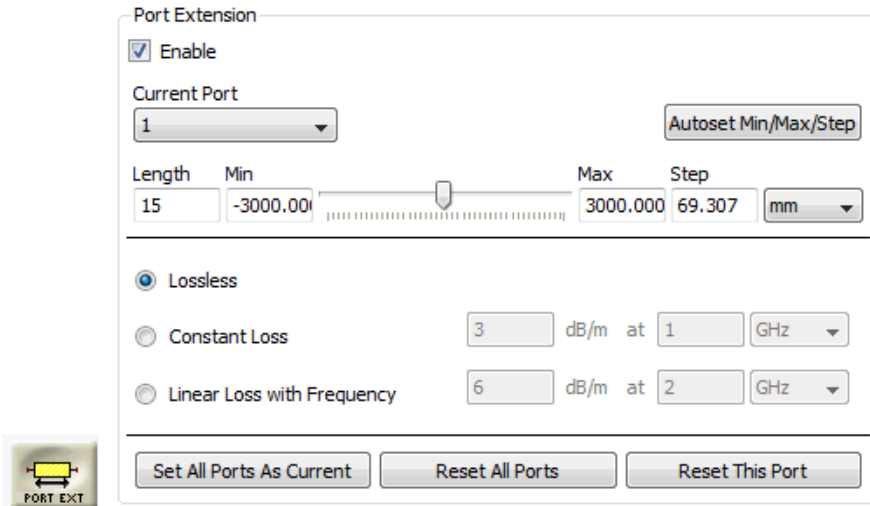

Now increase the length of the extension to 15mm which is a fractional wavelength. The result is a well behaved time domain trace without any reflections at unwanted times.

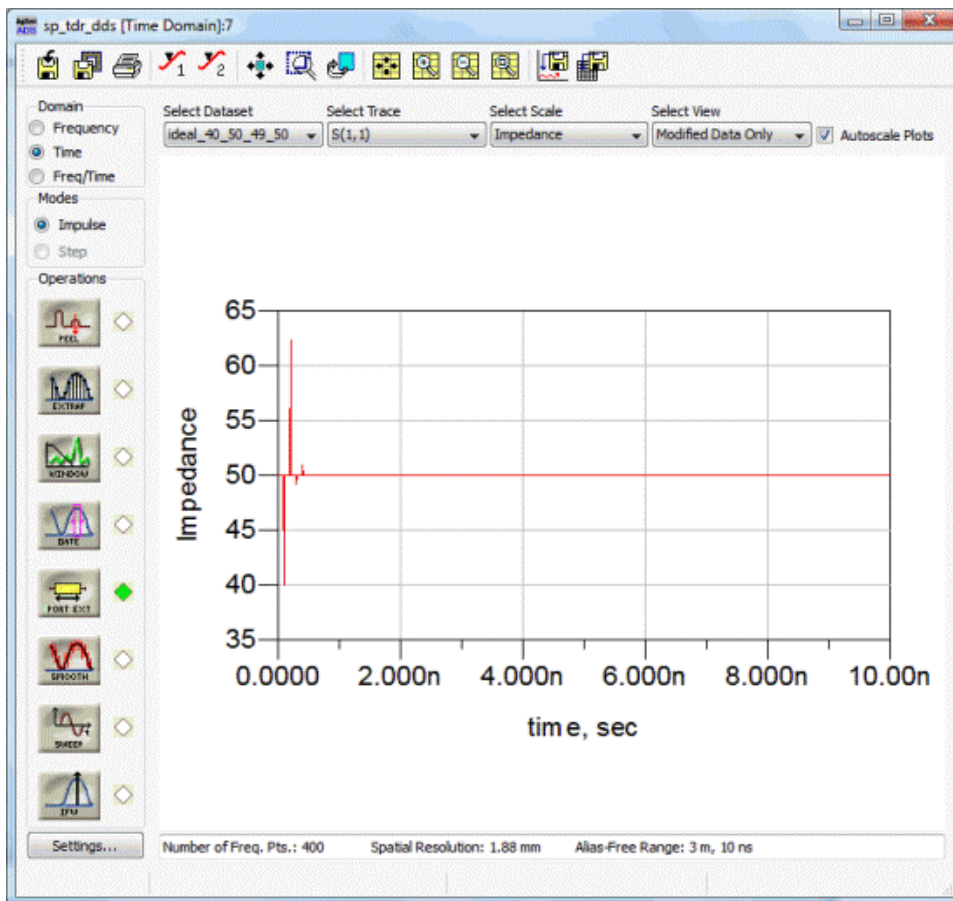

## Time Sweep

The Time Sweep area within the Settings dialog box is a good method of altering the view of the time domain trace and is different than simply zooming in on the desired time range. For example, use the main window to first change the Domain to Time and then use the toolbar buttons to zoom into the range from 0ns to 1ns.

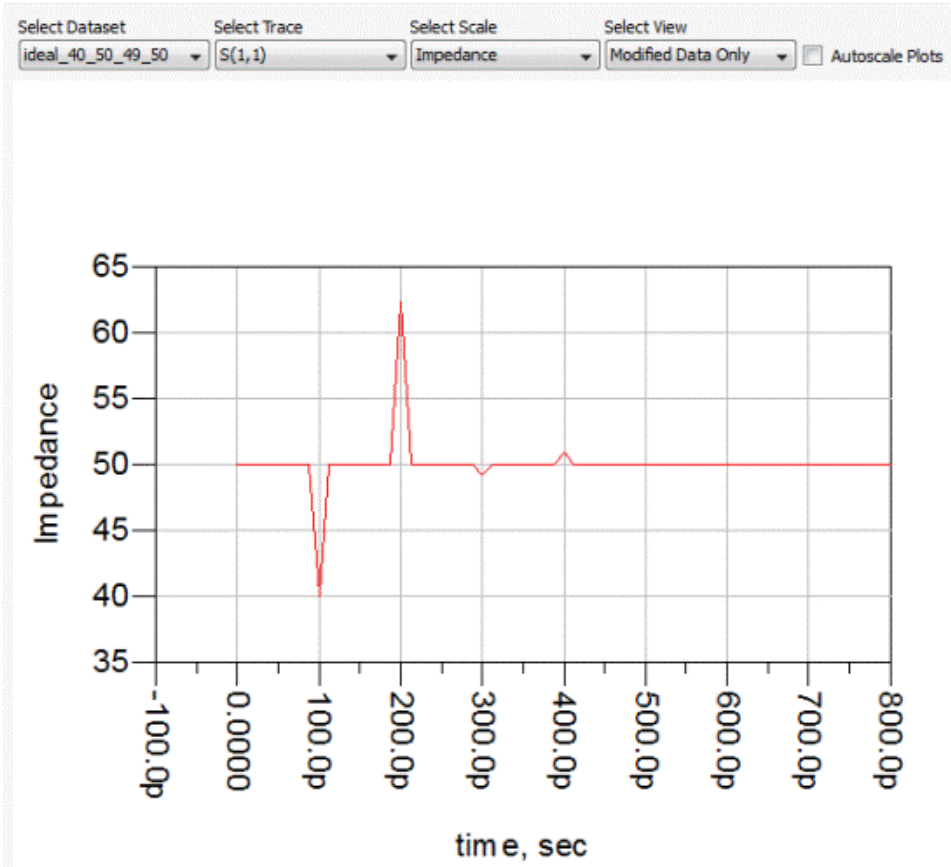

Notice that the resolution is poor. This occurs since zooming in the plot does not change the number of time domain samples; however, setting the Time Sweep alters the manner in which the IFFT is performed. Enable Time Sweep with sweep settings ranging from 0ns to 1ns with 401 temporal data points.

Frequency Transforms

Time Transforms

Time Sweep

Enable

Start Time  fs

Stop Time  ns

Step Time  ps

Time Points

Though the time extent of the plot does not change, the resolution of the trace is much better now.



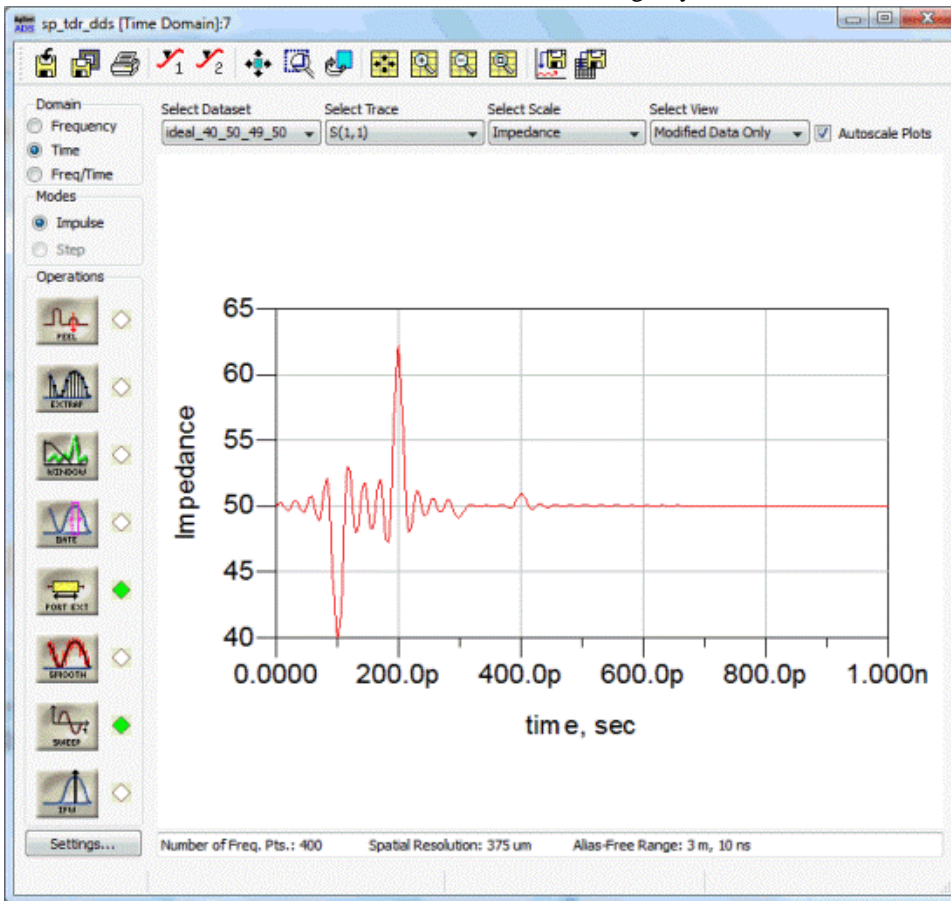

Unfortunately, there is significant ringing in the trace which will be taken care of by the Window operator.

## Window

Windowing in the frequency domain is a popular method of lessening the high frequency content in the time domain which lowers overall ringing of the waveform. Windowing can be enabled with default values by pressing the **Window** button in the main window or by clicking **Enable** in the corresponding area of Settings dialog box.

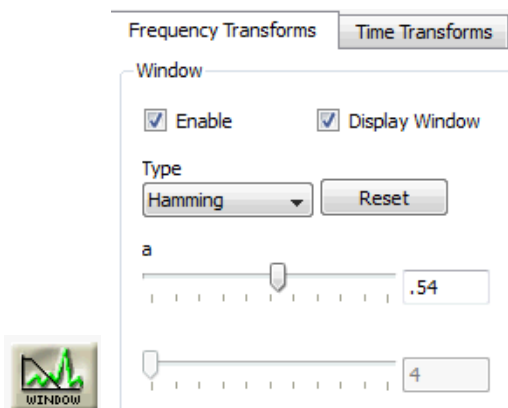

In addition to enabling the Window you can also select **Display Window** to see a scaled, overlaid trace of the Window response. Note that since there is no zero frequency point in the dataset, the Time Mode of the trace is fixed at Bandpass Impulse and the Window function is also bandpass.

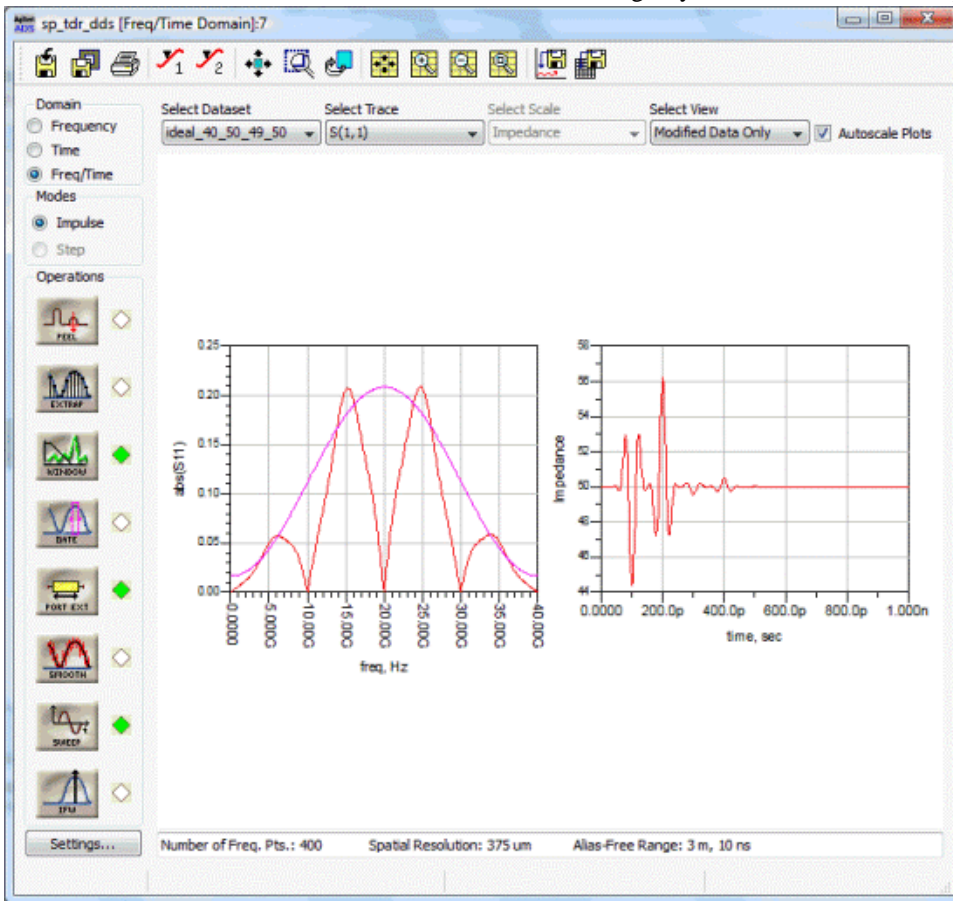

Change the SP TDR Domain in the main window to Freq/Time in order to see the Windowed frequency domain data and the time domain trace with less ringing. In order to enable lowpass Time Modes and examine the lowpass impulse and step responses of the data, the frequency data needs to start at 0 Hz. Low Frequency Extrapolation is used to find these points and enable lowpass Time Modes.

### Low Frequency Extrapolation

Low Frequency Extrapolation is a simple method to extrapolate any number of data points from the lowest frequency value in the dataset down to 0 Hz.

Low Freq. Impedance Extrapolation

Enable  Optimize

Frequency Step: 100 MHz [Default]

Extrapolation

Real: Order 3 Data Pts. 5

Imag: Order 3 Data Pts. 5

Zero Freq. Estimate

Enable Lossless Lir 12.153 Ohm S(1,1)

[Estimate Zero Freq.] [Estimate All]

Note

Low Freq. Extrapolation attempts to estimate low frequency points using known data. Enable Zero Freq. Estimate and/or Optimize to help achieve more accurate results.



A quick method of setting up Low Frequency Extrapolation is to press **Make Lowpass Waveform** in the Time Modes section of the Settings dialog box.

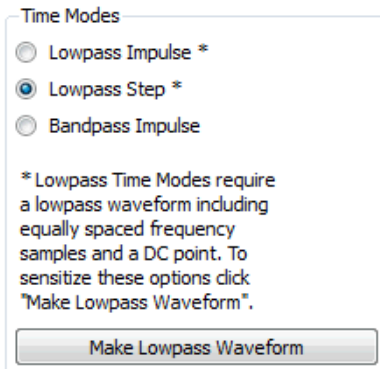

Notice that after pressing **Make Lowpass Waveform**, both Lowpass Time Modes as well as Low Frequency Extrapolation are enabled. Additionally, the Time Mode is automatically switched to the lowpass step mode. The result in the main window is a lowpass Window in the frequency domain and an impedance step response in the time domain.

**Caution**  
To accurately predict low frequency values, the time domain waveform must be causal. Noncausal data without a zero frequency point may result in inaccurate results.

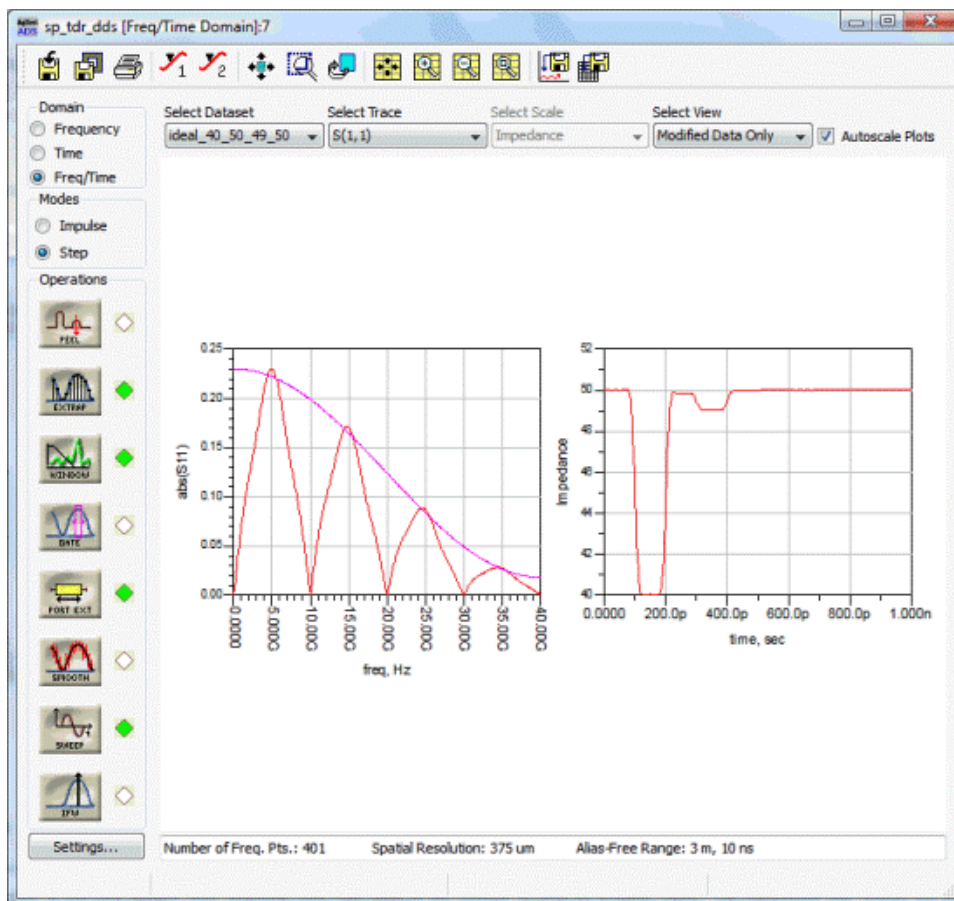

An interesting phenomenon occurs with closer examination of the time domain step response (you may want to set Domain to time for a better view). The impedance plot follows the expected values of

impedance sections from the simulated transmission line with a couple of exceptions. The first length of 50 Ohm line (after the extended port) is not quite exact nor is the following length of 49 Ohm line. This behavior is explained in the next section and can be counteracted by the Peeling algorithm.

## Peeling

When multiple discontinuities exist in a DUT then masking will occur at the output port. This means that energy from close-in discontinuities are reflected thus masking the true reflection coefficient from further-out discontinuities. For example, consider the forward and reverse traveling waves at the boundary of the  $k$ th discontinuity

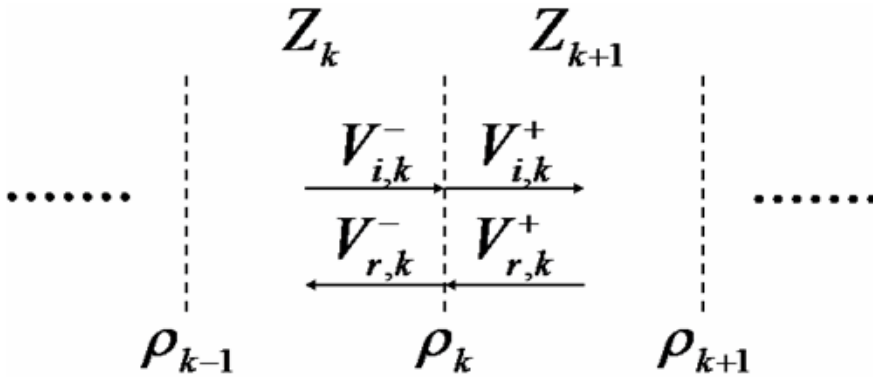

where reflection coefficient is defined by the reflected and incident voltages impinging on the sections

$$\rho_k = \frac{V_{r,k}^-}{V_{i,k}^+}$$

Using a recursion relation on the total of all reflected and incident waves, the original impedance value can be calculated. This is what the Peeling algorithm does.

Enable Peeling either by pressing the button on the TDR main window or selecting the checkbox in the Settings Dialog box.

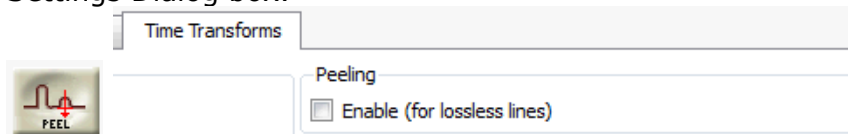

The corrected impedance values are now shown in the time domain step response. Note that the 50 and 49 Ohm lines are now more precisely represented in the impedance profile.

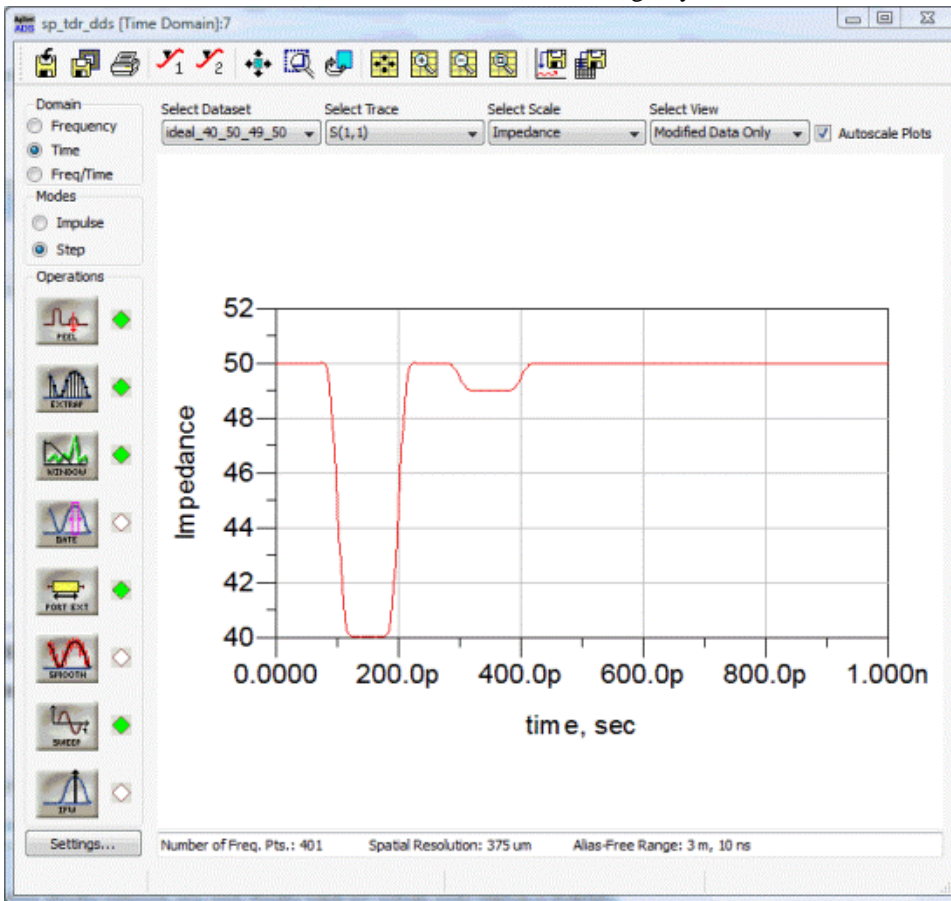

### Note

Since Peeling algorithm can produce unrealistic frequency domain response only time domain trace will change when Peeling is enabled.

## Gate

The Gate functions removes unwanted discontinuities as seen in the time domain allowing a view of the results in the frequency domain. Depending on the selected Time Mode, the Gate function behaves differently on time domain data.

The screenshot shows the Gate function configuration dialog box. The dialog is titled 'Gate' and contains several settings. The 'Enable for' dropdown is set to 'Step'. The 'Display Gate' checkbox is checked. The 'Autoset Min/Max/Step' button is visible. The 'Type' section has two radio buttons: 'Gate In (Notch)' (selected) and 'Gate Out (Bandpass)'. The 'Span' section has two radio buttons: 'Start/Length' (selected) and 'Center/Width'. The 'Start' field is set to .27, 'Min' is 0.000, 'Max' is 1.000, and 'Step' is 0.002. The 'Units' dropdown is set to 'ns'. The 'Length' field is set to .15, 'Min' is 0.000, 'Max' is 1.000, and 'Step' is 0.002. The 'Units' dropdown is set to 'ns'. A small icon labeled 'GATE' is shown in the bottom left corner.

As an example of the Gate function:

1. First press **Autoset Min/Max/Step** to get a good discretizaion of Gate values.
2. Next select **Display Gate** so the Gate window shows up in the main display.

There are three methods of altering Gate values:

1. Input Start/Center Length/Width values directly into the Settings dialog area.
2. Use the sliders to manipulate the Gate.
3. Directly drag-and-drop the Gate from within the main TDR window.

For this example, isolate the 49 Ohm section of line by setting the Start time to .27ns and the length to .15ns. Also, switch the Gate Type to Notch in order to remove everything within the Gate window.

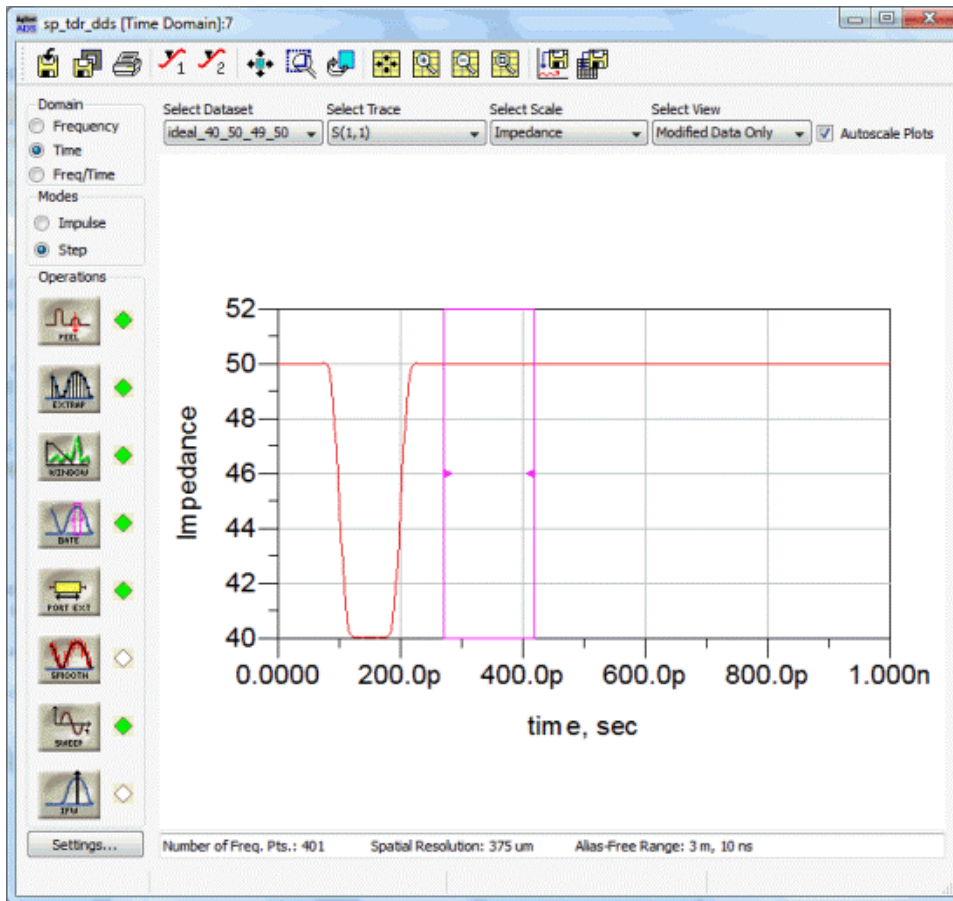

The 49 Ohm line is removed and replaced by an ideal (no reflections) connection between adjacent sections. The frequency response changes to match the new time step response.

## Other Operations

In addition to standard SP TDR Operations that were covered in the walkthrough, the SP TDR FrontPanel contains features for data preconditioning and mixed-mode S-parameter analysis.

### Smooth

Consider a lossless S-parameter simulation that has been corrupted by noise in the frequency domain.

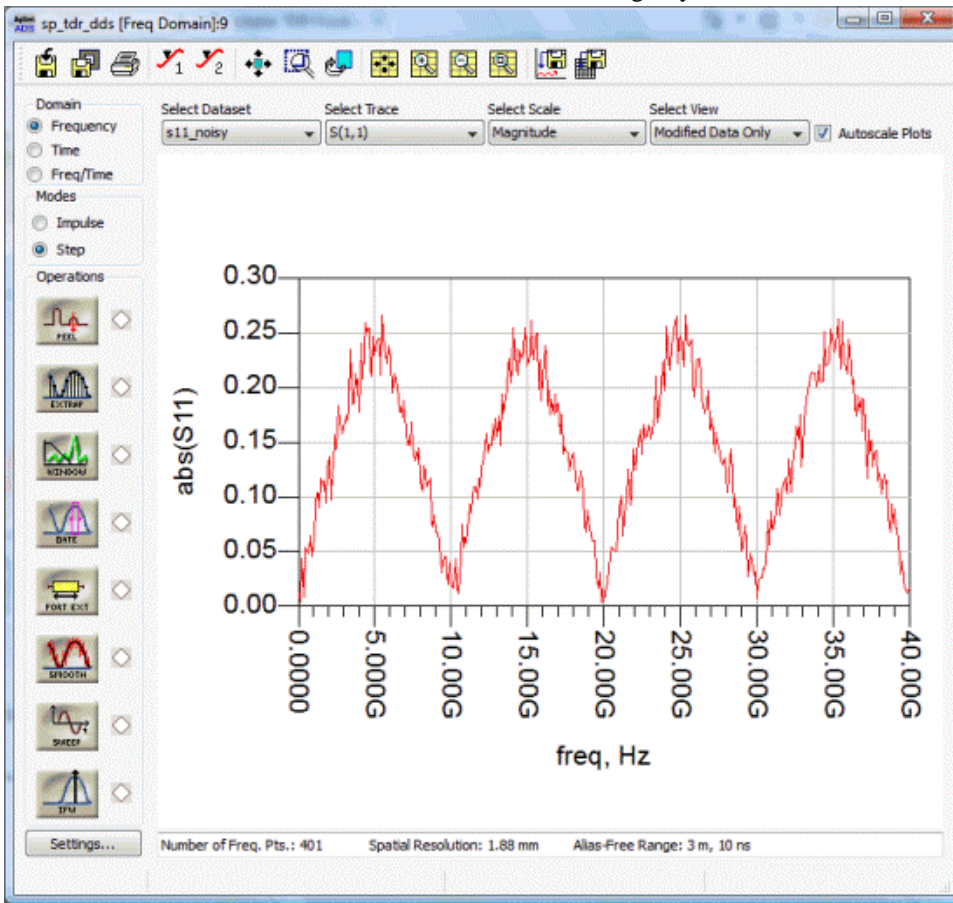

This dataset was created in ADS but could represent S-parameter extraction for an actual network analyzer. Smoothing operations on the input data can be enabled in the SP TDR for either Moving Average or Alpha-Beta filters.

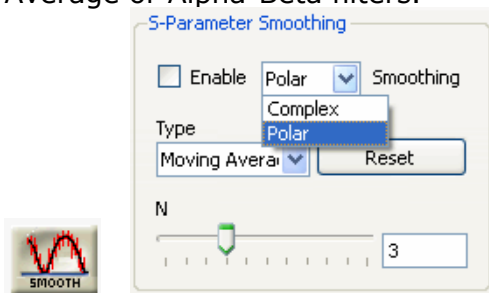

With the appropriate settings, these functions can remove much of the noise seen in the input dataset.

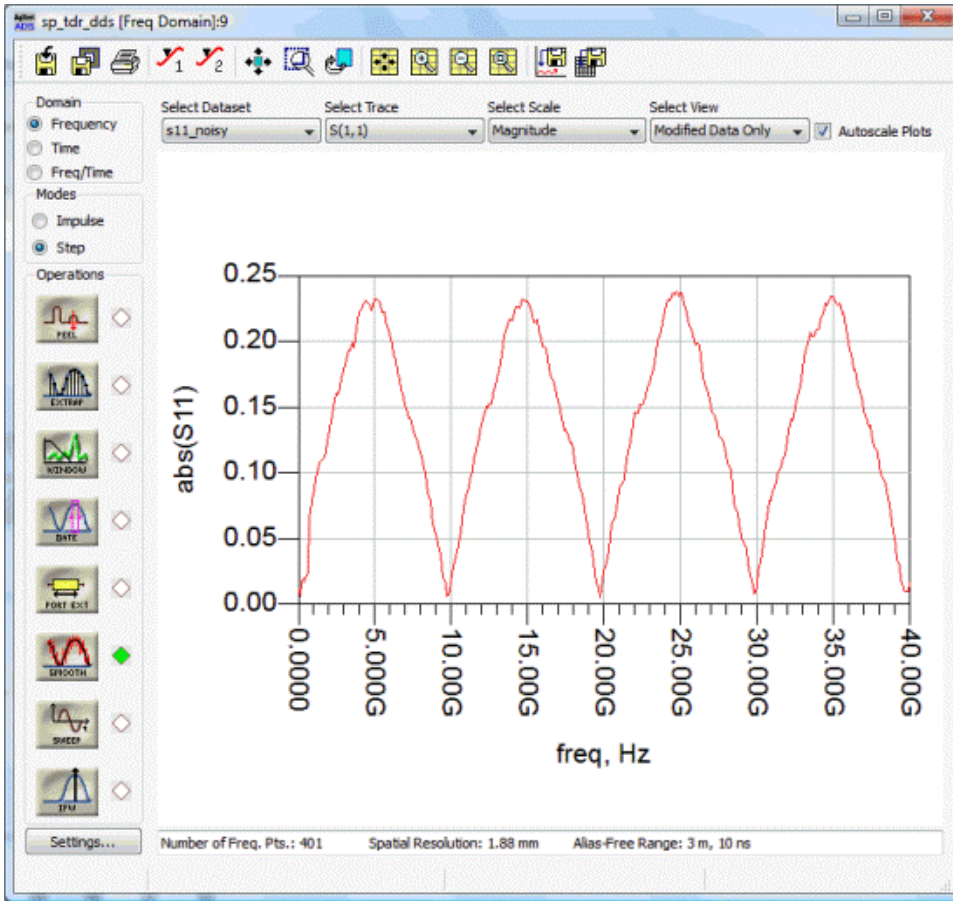

## Impulse File Writer

The ADS Impulse File Writer(IFW) component provides for a time-domain convolution simulation of S-parameter data. In the SP TDR FrontPanel, the IFW simulation opens an ADS schematic window,

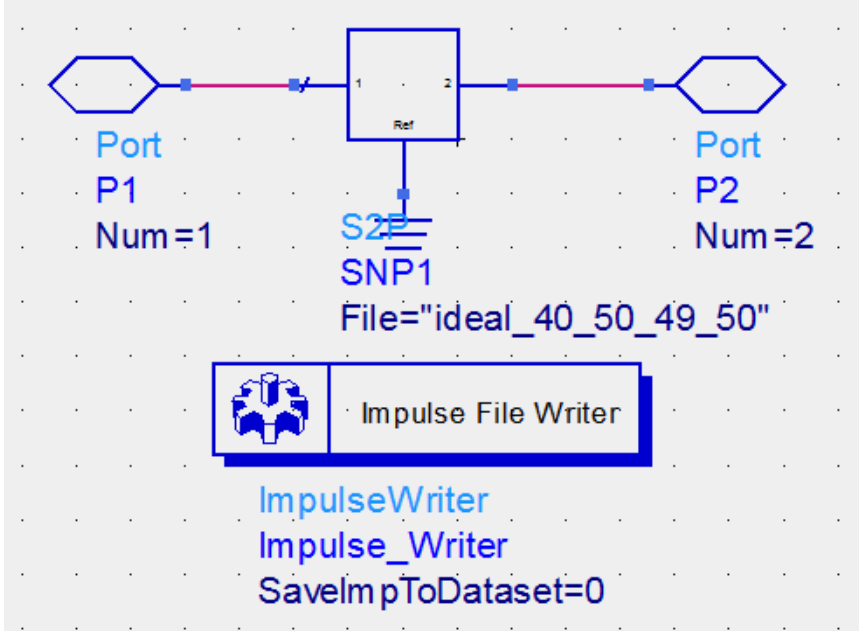

converts the currently selected S-parameters into time domain impulse responses, which accurately represent the original spectrum, which are then read back into the SP TDR without overwriting the current dataset itself. The causality problem associated with band-limited spectrum is circumvented using proprietary technology and the computed impulses are guaranteed to be causal. To run the IFW simulation simply press the IFW button on the main window or select "Run IFW Simulation" from the



## settings dialog



The IFW simulation will automatically open a new simulation design with the appropriate components. Once the simulation has terminated, the time-domain impulse data for the selected dataset will be read into the TDR as long as the IFW operation is "on".

**Caution**

The SP TDR FrontPanel IFW simulation only allows input datasets with up to four ports. Larger datasets would need to be simulated manually with the IFW component prior to manipulation within the SP TDR FrontPanel.

## Port Mapping

Port Mapping accepts as input a dataset with  $N > 3$  ports and converts it to 4-ports in the desired order. To open Port Mapping dialog box, click on **Map Ports...** in the Frequency Mode area of the Settings dialog box.

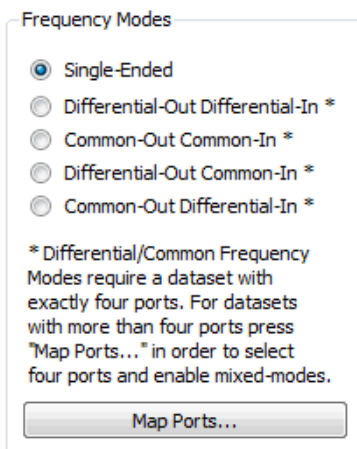

For datasets with less than four ports Port Mapping is not available. After selecting **Map Ports...** the Port Mapping dialog box will appear.

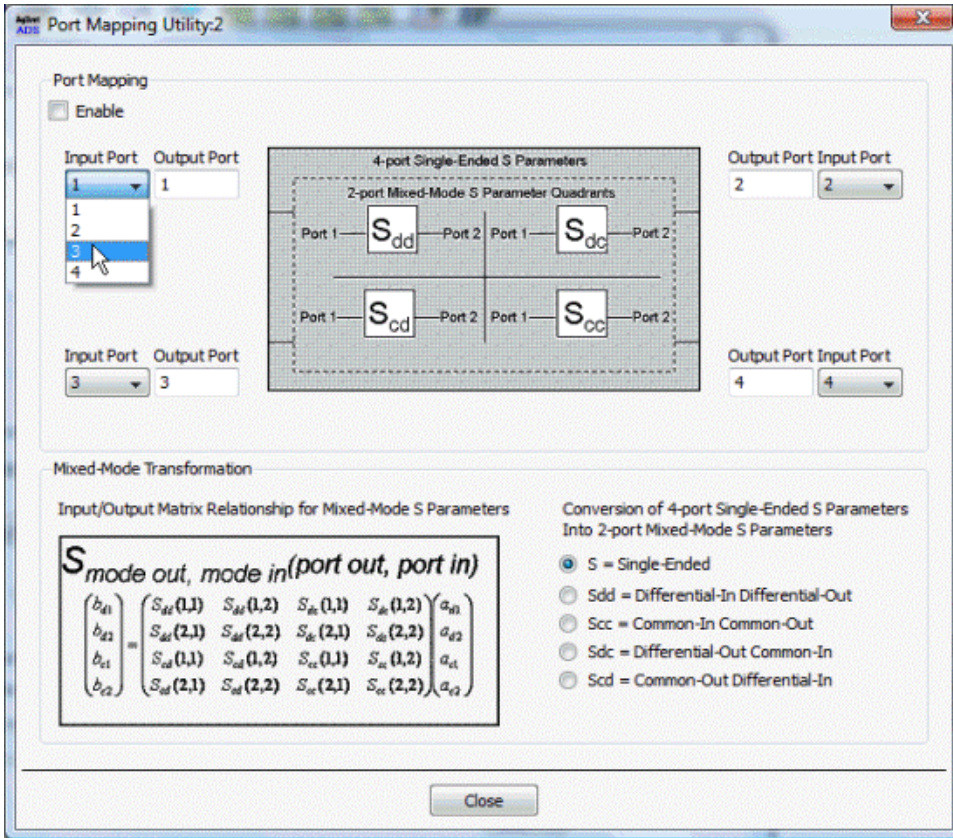

Using the dropdown lists allows any port from the input dataset to be mapped to one of four ports for differential S-parameter analysis or for nominal single-ended use.

### Mixed-Mode S-Parameters

Frequency Modes

- Single-Ended
- Differential-Out Differential-In \*
- Common-Out Common-In \*
- Differential-Out Common-In \*
- Common-Out Differential-In \*

\* Differential/Common Frequency Modes require a dataset with exactly four ports. For datasets with more than four ports press "Map Ports..." in order to select four ports and enable mixed-modes.

Map Ports...

The SP TDR is capable of converting from a 4-port single-ended dataset into 2-port mixed-mode datasets. Mixed-mode simulations are often used for high-speed circuits such as PCB or amplifiers to examine the DUT behavior with differential or common mode stimuli. For example, consider a pair of coupled transmission lines with a common grounding plane:



This device can be excited in various manners depending on the desired even or odd mode. For clarity we write the above circuit, or any such DUT, as a 4-port black box.

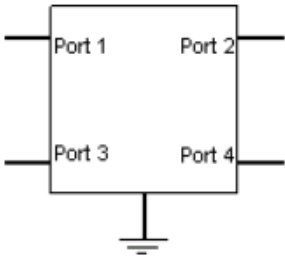

with a common terminal. Each of the mixed-mode stimuli demonstrate different aspects of the DUT

**Differential-Out Differential-In**

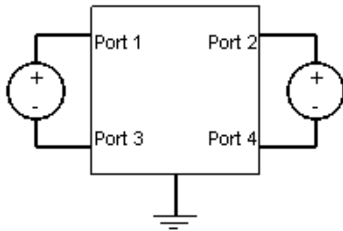

- Single-ended S-parameter simulation with differential or odd-mode stimuli.
- Used for analyzing differential behavior of the DUT.
- Is most often the "desired" signal.

**Differential-Out Common-In**

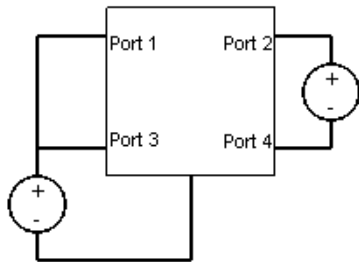

- Demonstrates susceptibility to external interferences.
- Sdc is ideally zero.

**Common-Out Differential-In**

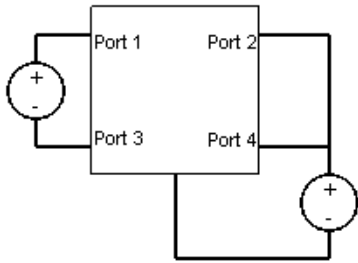

- Demonstrates EM noise "leakage" from the DUT to other interconnects.
- Coupled imbalance is detrimental to overall performance.
- Scd is ideally zero.

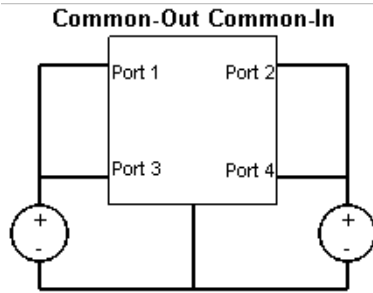

- Single-ended S-parameter simulation with common- or even-mode stimuli.
- Is most often the "undesired" signal.

One of the key benefits is that only a single 4-port simulation performed on the DUT is necessary. After simulating, linear conversions can be performed on the S-parameter matrices in order to view the desired mixed-mode traces.

## Exported List Data (CSV Format)

As explained in *Exporting a Data Display List to a CSV file (data)*, data from list plots can be exported in CSV format. This section provides more detailed information about CSV data export.

### About the Format

The comma separated values format (CSV) is a popular solution to the problem of exchanging and converting data between various applications and spreadsheet programs. The Data Display export feature adheres to the CSV standard as it is formally described at: <http://tools.ietf.org/html/rfc4180> .

### CSV Data Export Process

The user can export data from a list by either of the following methods:

- Using the context-sensitive popup menu for a List plot, and selecting **Export/CSV File**.
- Using the pulldown menu pick **File > Export > List to CSV File**.

After the user selects one of these menu picks, the standard file browser is then displayed, and the user is allowed to enter a file name for the export file. The CSV extension is automatically added to the file. When the user selects the OK button, the data is exported. The data is exported using the same numeric format that is displayed in the list plot. For more information about list formatting, see *Editing Lists (data)*.

Data can only be exported from list plots. Other plot types will not support export of CSV data.

### Multiple list plots

Multiple objects may be pre-selected before executing the export menu pick. In this case, any object that is not a List plot will be ignored. Post-selection is not supported. If no list plots are selected, the export menu pick is inactive.

If multiple listings are exported, all the data will be placed in the CSV file side by side. However, the independent data will not be shared between listings even if the data is equivalent. For example, if two listings have data that depends on "freq", the data for "freq" will be exported twice into the CSV file (once for the first listing and once for the second listing).

### Independent Data

Independent data is exported only if the **Display Independent Data** checkbox (in the **Plot Options** for the list plot) is checked. However, the box is checked by default when a list plot is created.

The independent data is always exported before the dependent data. If the last independent data is the same as the current independent data, then only the dependent data will be exported. That is, the data is exported as it is displayed in the list plot. If there are two traces with the same independent data, then that data is displayed only once in the listing. However, if the independent data is different, then each trace will have its own column for independent data; the same is true of the exported CSV data.

### Matrix Data

Matrix data has each matrix element exported in a separate column. For example, if the List plot has S-Parameter data and the user has listed S, instead of S being exported, each column is listed separately in the export file. If the S-Parameter data is defined as a 2x2 matrix, then the user will see in the export file S(1,1), S(1,2), S(2,1) and S(2,2) as individual columns.

**Note**

An application such as Excel may or may not accept complex numbers stated in a given format. Users need to display complex numbers in Data Display lists in whatever format is acceptable to the application to which the data will be transferred, so that the exported CSV data can be imported successfully by that application. For more information about complex numbers in lists, see *Setting List Preferences (data)*.

## Swept Data

Swept data will generate a column for each sweep that the data being exported depends upon. The columns will be created in the same order as the dependency for the data.

## Simple Data Export Example

In this example the exported data is very simple (it isn't swept, and isn't matrix data):

freq	data
1.000 GHz	-0.342
1.100 GHz	-0.278
1.200 GHz	-0.128
1.300 GHz	-0.009
1.400 GHz	-0.037
1.500 GHz	-0.182
1.600 GHz	-0.313
1.700 GHz	-0.335
1.800 GHz	-0.233
1.900 GHz	-0.078

In this case the data being exported has a dependency on the data called "freq"; it has 10 data points, is scalar (not a matrix) and is real data:

what(data)
Dependency : [freq]
Num. Points : [10 ]
Matrix Size : scalar
Type : Real

In the listing below, you can see the output in CSV format. Notice that the first line includes the header information obtained from the what() command for the trace and other sources. Since the data is coming from a list plot, the format of the exported data will match the format of the data in the list:

```
"freq
References : ['data']
Dependency : []
Num Points : [10]
Matrix Size : scalar
Type : Real","data
References : []
Dependency : [freq]
Num Points : [10]
Matrix Size : scalar
Type : Real"
1.000 GHz,-0.342
1.100 GHz,-0.278
```

1.200 GHz,-0.128  
 1.300 GHz,-0.009  
 1.400 GHz,-0.037  
 1.500 GHz,-0.182  
 1.600 GHz,-0.313  
 1.700 GHz,-0.335  
 1.800 GHz,-0.233  
 1.900 GHz,-0.078

## Matrix Data Export Example

In this example the data being exported is matrix data. In this case we are exporting a 2x2 matrix. The data being exported is complex data:

freq	data			
	data(1,1)	data(1,2)	data(2,1)	data(2,2)
1.000 GHz	-9.312 / -3.142	-0.541 / 1.571	-0.541 / 1.571	-9.312 / -3.142
1.100 GHz	-10.209 / 2.695	-0.435 / 1.124	-0.435 / 1.124	-10.209 / 2.695
1.200 GHz	-13.581 / 2.229	-0.195 / 0.658	-0.195 / 0.658	-13.581 / 2.229
1.300 GHz	-24.899 / 1.738	-0.014 / 0.167	-0.014 / 0.167	-24.899 / 1.738
1.400 GHz	-19.026 / -1.904	-0.055 / -0.333	-0.055 / -0.333	-19.026 / -1.904
1.500 GHz	-12.060 / -2.387	-0.279 / -0.817	-0.279 / -0.817	-12.060 / -2.387
1.600 GHz	-9.699 / -2.845	-0.492 / -1.274	-0.492 / -1.274	-9.699 / -2.845
1.700 GHz	-9.407 / 2.994	-0.529 / -1.719	-0.529 / -1.719	-9.407 / 2.994
1.800 GHz	-10.974 / 2.543	-0.362 / -2.170	-0.362 / -2.170	-10.974 / 2.543
1.900 GHz	-15.747 / 2.068	-0.117 / -2.645	-0.117 / -2.645	-15.747 / 2.068

The "what(data)" information for the data is:

what(data)
Dependency : [freq]
Num. Points : [10]
Matrix Size : (2,2)
Type : Complex

The data is exported as:

```
"freq
References : ['data(1,1)', 'data(1,2)', 'data(2,1)', 'data(2,2)']
Dependency : []
Num Points : [10]
Matrix Size : scalar
Type : Real", "data(1,1)
References : []
Dependency : [freq]
Num Points : [10]
Matrix Size : (2,2)
Type : Complex
Complex Format : dB/Rad", "data(1,2)
References : []
Dependency : [freq]
Num Points : [10]
Matrix Size : (2,2)
Type : Complex
Complex Format : dB/Rad", "data(2,1)
References : []
Dependency : [freq]
Num Points : [10]
Matrix Size : (2,2)
Type : Complex
Complex Format : dB/Rad", "data(2,2)
```

```

References : []
Dependency : [freq]
Num Points : [10]
Matrix Size : (2,2)
Type : Complex
Complex Format : dB/Rad"
1.000 GHz,-9.312 / -3.141,-0.541 / 1.571,-0.541 / 1.571,-9.312 / -3.142
1.100 GHz,-10.209 / 2.695,-0.435 / 1.124,-0.435 / 1.124,-10.209 / 2.695
1.200 GHz,-13.581 / 2.229,-0.195 / 0.658,-0.195 / 0.658,-13.581 / 2.229
1.300 GHz,-24.899 / 1.738,-0.014 / 0.167,-0.014 / 0.167,-24.899 / 1.738
1.400 GHz,-19.026 / -1.904,-0.055 / -0.333,-0.055 / -0.333,-19.026 / -1.904
1.500 GHz,-12.060 / -2.387,-0.279 / -0.817,-0.279 / -0.817,-12.060 / -2.387
1.600 GHz,-9.699 / -2.845,-0.492 / -1.274,-0.492 / -1.274,-9.699 / -2.845
1.700 GHz,-9.407 / 2.994,-0.529 / -1.719,-0.529 / -1.719,-9.407 / 2.994
1.800 GHz,-10.974 / 2.543,-0.362 / -2.170,-0.362 / -2.170,-10.974 / 2.543
1.900 GHz,-15.747 / 2.068,-0.117 / -2.645,-0.117 / -2.645,-15.747 / 2.068
    
```

## Swept Data Export Example

In this example a simple data sweep is handled.

freq	data	
	Zo1=35.000	Zo1=85.000
1.000 GHz	-0.342	0.486
1.100 GHz	-0.278	0.528
1.200 GHz	-0.128	0.594
1.300 GHz	-0.009	0.601
1.400 GHz	-0.037	0.514
1.500 GHz	-0.182	0.332
1.600 GHz	-0.313	0.091
1.700 GHz	-0.335	-0.107
1.800 GHz	-0.233	-0.145
1.900 GHz	-0.078	-0.056

The "what(data)" information for the data is:

what(data)
Dependency : [Zo1,freq] Num. Points : [2, 10] Matrix Size : scalar Type : Real

The data is exported as:

```

"Zo1
References : ['data']
Dependency : []
Num Points : [2]
Matrix Size : scalar
Type : Real","freq
References : ['data']
Dependency : []
Num Points : [10]
Matrix Size : scalar
Type : Real","data
References : []
Dependency : [Zo1,freq]
Num Points : [2,10]
Matrix Size : scalar
Type : Real"
    
```



```

35.000,1.000 GHz,-0.342
35.000,1.100 GHz,-0.278
35.000,1.200 GHz,-0.128
35.000,1.300 GHz,-0.009
35.000,1.400 GHz,-0.037
35.000,1.500 GHz,-0.182
35.000,1.600 GHz,-0.313
35.000,1.700 GHz,-0.335
35.000,1.800 GHz,-0.233
35.000,1.900 GHz,-0.078
85.000,1.000 GHz,0.486
85.000,1.100 GHz,0.528
85.000,1.200 GHz,0.594
85.000,1.300 GHz,0.601
85.000,1.400 GHz,0.514
85.000,1.500 GHz,0.332
85.000,1.600 GHz,0.091
85.000,1.700 GHz,-0.107
85.000,1.800 GHz,-0.145
85.000,1.900 GHz,-0.056
    
```

## Swept Matrix Data Export Example

The final example will show a mix of swept matrix data. The data display listing is:

freq	data
<b>Zo1=35.000, data(1)</b>	
1.000 GHz	-0.342
1.100 GHz	-0.278
1.200 GHz	-0.128
1.300 GHz	-0.009
1.400 GHz	-0.037
1.500 GHz	-0.182
1.600 GHz	-0.313
1.700 GHz	-0.335
1.800 GHz	-0.233
1.900 GHz	-0.078
<b>Zo1=35.000, data(2)</b>	
1.000 GHz	-1.622E-16
1.100 GHz	0.411
1.200 GHz	0.774
1.300 GHz	0.984
1.400 GHz	0.939
1.500 GHz	0.663
1.600 GHz	0.276
1.700 GHz	-0.139
1.800 GHz	-0.541
1.900 GHz	-0.867
<b>Zo1=85.000, data(1)</b>	
1.000 GHz	0.486
1.100 GHz	0.528
1.200 GHz	0.594
1.300 GHz	0.601
1.400 GHz	0.514
1.500 GHz	0.332
1.600 GHz	0.091
1.700 GHz	-0.107
1.800 GHz	-0.145
1.900 GHz	-0.056
<b>Zo1=85.000, data(2)</b>	
1.000 GHz	-1.796E-16
1.100 GHz	0.420
1.200 GHz	0.668
1.300 GHz	0.755
1.400 GHz	0.741
1.500 GHz	0.638
1.600 GHz	0.403
1.700 GHz	-0.002
1.800 GHz	-0.493
1.900 GHz	-0.868

The swept matrix data "what()" output is:

what(data)
Dependency : [Zo1,freq]
Num. Points : [2, 10]
Matrix Size : (2)
Type : Real

The swept matrix data is exported as:

```
"Zo1
References : ['data(1)','data(2)']
Dependency : []
Num Points : [2]
Matrix Size : scalar
Type : Real","freq
References : ['data(1)','data(2)']
Dependency : []
Num Points : [10]
Matrix Size : scalar
Type : Real","data(1)
References : []
Dependency : [Zo1,freq]
Num Points : [2,10]
Matrix Size : scalar
Type : Real","data(2)
References : []
Dependency : [Zo1,freq]
Num Points : [2,10]
Matrix Size : scalar
Type : Real"
35.000,1.000 GHz,-0.342,-1.622e-16
35.000,1.100 GHz,-0.278,0.411
35.000,1.200 GHz,-0.128,0.774
35.000,1.300 GHz,-0.009,0.984
35.000,1.400 GHz,-0.037,0.939
35.000,1.500 GHz,-0.182,0.663
35.000,1.600 GHz,-0.313,0.276
35.000,1.700 GHz,-0.335,-0.139
35.000,1.800 GHz,-0.233,-0.541
35.000,1.900 GHz,-0.078,-0.867
85.000,1.000 GHz,0.486,01.796e-16
85.000,1.100 GHz,0.528,0.420
85.000,1.200 GHz,0.594,0.668
85.000,1.300 GHz,0.601,0.755
85.000,1.400 GHz,0.514,0.741
85.000,1.500 GHz,0.332,0.638
85.000,1.600 GHz,0.091,0.403
85.000,1.700 GHz,-0.107,-0.002
85.000,1.800 GHz,-0.145,-0.493
85.000,1.900 GHz,-0.056,-0.868
```

Here is the data imported into Microsoft Excel:

	A	B	C	D	E
1	Zo1	freq	data(1)	data(2)	
2	35	1.000 GHz	-0.342	-1.62E-16	
3	35	1.100 GHz	-0.278	0.411	
4	35	1.200 GHz	-0.128	0.774	
5	35	1.300 GHz	-0.009	0.984	
6	35	1.400 GHz	-0.037	0.939	
7	35	1.500 GHz	-0.182	0.663	
8	35	1.600 GHz	-0.313	0.276	
9	35	1.700 GHz	-0.335	-0.139	
10	35	1.800 GHz	-0.233	-0.541	
11	35	1.900 GHz	-0.078	-0.867	
12	85	1.000 GHz	0.486	1.80E-16	
13	85	1.100 GHz	0.528	0.42	
14	85	1.200 GHz	0.594	0.668	
15	85	1.300 GHz	0.601	0.755	
16	85	1.400 GHz	0.514	0.741	
17	85	1.500 GHz	0.332	0.638	
18	85	1.600 GHz	0.091	0.403	
19	85	1.700 GHz	-0.107	-0.002	
20	85	1.800 GHz	-0.145	-0.493	
21	85	1.900 GHz	-0.056	-0.868	
22					
23					

**Note**

By default, the header line displays the name only; clicking on the cell causes the entire header entry to be displayed.

# Running the Data Display as a Stand-Alone Program

This section explains how to use a command line to run the Data Display as an independent application.

## Note

Command-line functions depend upon the proper setup of environment variables (such as `HPPEESOF_DIR`). See *Windows Installation (instalpc)* or *UNIX and Linux Installation (install)*, as appropriate, for more information about these variables.

## The dds Command

To invoke Data Display as a stand-alone program, open a shell window (or command prompt window, in the Windows PC environment) and use the `dds` command:

```
dds [-dataset ] [-cmd ] [-32bit] [-64bit] []
```

The options and arguments for this command do not need to be placed in the order shown above. Any of them can be omitted, and some of them can be repeated within the command line.

Each time the `dds` command is issued, a new Data Display process is started. A process started in this way will not communicate with or be aware of other Data Display processes which may be running, regardless of how they were launched (by command or from within ADS or GoldenGate sessions).

The Data Display process that is started by the `dds` command will monitor the data directory for changes in datasets, and update any plots utilizing data that has changed.

The options and arguments for the `dds` command are listed in the table below.

Option/Argument	Description
-dataset <datasetFile>	The parameter passed in here is the path and name of a dataset file (<path>/<filename>.ds); make this the default dataset, to be used for all subsequent Data Display files and windows opened (until another -dataset option changes it). This option can be repeated within the command line. Relative path names to the dataset file are acceptable. See <a href="#">Using the -dataset Option</a> below for details.
-cmd <commandFile>	The parameter passed in here is the name of a command file; execute the commands contained in this file. See <a href="#">Using the -cmd Option</a> below for details.
-32bit	On a 64-bit system, start the Data Display in 32-bit mode. In Microsoft Windows, 32-bit mode is the default setting; in UNIX or Linux, the appropriate mode is set automatically.
-64bit	On a 64bit system, start the Data Display in 64bit mode. In Microsoft Windows, 32-bit mode is the default setting; in UNIX or Linux, the appropriate mode is set automatically.
<dataDisplayFile>	The path and name of an existing Data Display file (<path>/<filename>.dds). Use the Data Display window (as defined in this file) to show the content of the default dataset (as specified by the -dataset option). This argument can be repeated within the command line. If the argument is omitted, a new and unnamed Data Display window is opened. If the Data Display file exists in the directory where you execute the <code>dds</code> command then no paths specification is required. Relative path names are acceptable. See <a href="#">Using the &lt;dataDisplayFile&gt; Argument</a> for details.

## File Paths in the dds Command

Where file names are given in the `dds` command (or in a command file referenced by the `dds` command), the file is assumed to be located in the current working directory; if it is not, use a file path relative to the working directory.

**Note**

If you use the `dds` command in the Windows PC environment, be aware that the command cannot be called from any location for which the file path includes spaces (for example, "C:\Documents and Settings").

## Using the `-dataset` Option

The `-dataset` command line option specifies that the next parameter on the command line names the file that is to be used as the default dataset. This default dataset will replace the default dataset specified in the Data Display file, and will be used by any new Data Display windows launched:

```
dds -dataset data/set1.ds disp1.dds
```

This option can be repeated as many times as necessary within the command line, to use a different dataset for each of several Data Display files:

```
dds -dataset data/set1.ds disp1.dds -dataset data/set2.ds disp2.dds -dataset
../other_wrk/data/set3.ds disp3.dds
```

**Note**

The data display file and data directory in which the dataset file resides are expected to share the same parent directory:  
`parentDirectory/dataDisplayFile`  
`parentDirectory/data/datasetFile`

If this condition is met, the dataset is added to the data display file as the normal default dataset. However, if the parent directories are not the same, or if the data directory is called something other than `data`, an alias is created for the dataset, and that alias is used to specify the default dataset for the data display file.

If the specified dataset is not found, this option will be silently ignored.

If this option is omitted from the command, or if it is ignored because the specified dataset is not found, the default dataset of the data display file is used.

## Using the `-cmd` Option

The `-cmd` command line option specifies that the next parameter on the command line names a file containing commands which are to be processed by the Data Display before control is passed to the user.

```
dds -cmd file1.cmd
```

If the command file is located in the current working directory, the filename alone is sufficient; if it is located elsewhere, enter a path relative to the working directory, or an absolute path.

**Note**

It is not necessary to give the command file the `.cmd` file extension (or any other file extension), but doing so is an easy way to make command files recognizable.

This option can be repeated as many times as necessary within the command line, to process commands from multiple files:

```
dds -cmd file1.cmd -cmd file2.cmd -cmd file3.cmd
```

The command file can contain any combination of the commands listed in the table below. Each command is placed on its own line in the command file. The commands can be repeated as many times as necessary, and placed in any sequence. (However, any command which is placed after an EXIT command will not be executed.)

Command	Purpose
CMD NEW_WIN	Open a new Data Display window.
CMD CHDIR <dir>	Change the current working directory to the directory specified. The directory change only applies to commands following the CHDIR command. Multiple CHDIR commands can be included in a single command file. If no CHDIR command is included in the command file then the directory where you started the dds command will be used as the current working directory.
CMD OPEN_FILE <dataDisplayFile>	Open the specified Data Display file. Full, relative and no path can be used with the Data Display file name. (The file must exist already; if it does not, this command is ignored.)
CMD CLOSE_FILE <dataDisplayFile>	Close the specified Data Display file. Full, relative and no path can be used with the Data Display file name. (The user will be prompted to save any changes.)
CMD CREATE_OR_OPEN_FILE <dataDisplayFile>;<templateFile>	Open the specified Data Display file (creating it if it does not already exist), and insert the specified template file if the Data Display file is empty. If the Data Display file is not empty, the <templateFile> parameter is ignored. The <templateFile> argument can be omitted, in which case the Data Display file is left as is. Full, relative and no path can be used with the Data Display and Template file names. The semi-colon (";") is required between the Data Display file name and the Template file name.
CMD MOST_LIKELY_DATASET <datasetFile>	Use the specified dataset file as the default dataset for new Data Display windows. This command only accepts the dataset file name without any path specification. The dataset is expected to reside in the data directory that exists in the current working directory. (This command is ignored if the named file does not exist.)
CMD SET_DEFAULT_DATASET <datasetFile>	Use the specified dataset file as the default dataset for the current Data Display window only. This command only accepts the dataset file name without any path specification. The dataset is expected to reside in the data directory that exists in the current working directory of the Data Display file. (This command is ignored if the named file does not exist.)
EXIT	Exit the current Data Display session <b>without</b> saving. (This command is <i>not</i> preceded by CMD.)

For example, if the command file called `invok1.cmd` contains these commands:

```
CMD OPEN_FILE win1.dds
CMD SET_DEFAULT_DATASET dat1.ds
```

The effect of entering the command line `dds -cmd invok1.cmd` would be to open a Data Display window which shows the Data Display file `win1.dds` and uses `dat1.ds` (located in the `data` subdirectory of the current working directory) as the default dataset for that display.

## Using the <dataDisplayFile> Argument

This argument is used to specify the name of an existing Data Display file (<filename>.dds), which determines the configuration of the new Data Display window which is opened by the `dds` command.

The file named in this argument must exist already; if the name specified does not match an existing file, this argument is ignored and a new, unnamed Data Display window is opened by the command.

This argument can be omitted, in which case a new, unnamed Data Display window is opened by the command.

This argument can be repeated as many times as necessary within the command line to open multiple Data Display windows:

```
dds -dataset data/set1.ds disp1.dds disp2.dds disp3.dds
```

In the example above, three Data Displays are opened, using three different Data Display files, but the same dataset is used for all three because the command specifies the dataset only once. It will also become the default dataset used by new Data Display files that are created.